



SET-UP INSTRUCTIONS

IMPORTANT: DO NOT USE EXCESSIVE FORCE DURING ANY PART OF SET-UP

NOTE: First Time Assembly

Canopy top and frame will be shipped via two packages to avoid damage. For first time set up requires that top be attached on to the frame with velcro. Once canopy top is permanently attached, set up and take down are easily accomplished within seconds.

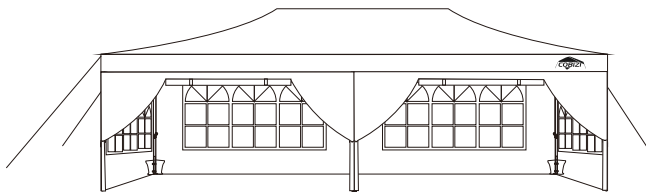

• English

Pop-Up Canopy

PARTS LIST

Make sure all the parts are in correct number.
Any parts missing, please feel free to contact.

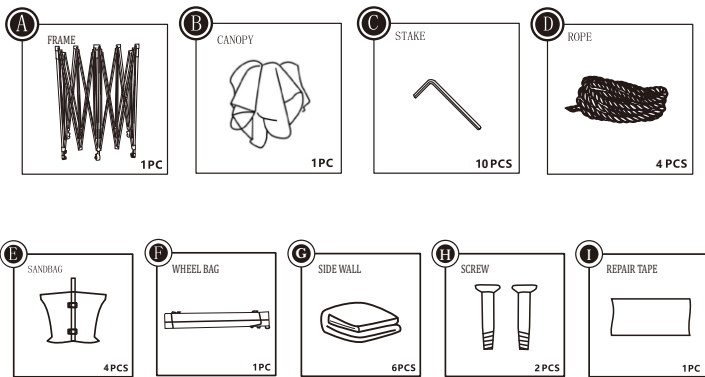

Pls note: Spare screws(H), can be used or replaced when screws in frame was missed or damaged.

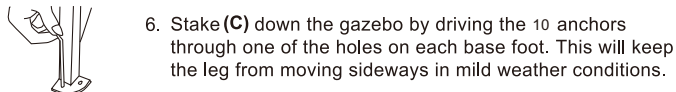

6. Stake (C) down the gazebo by driving the 10 anchors through one of the holes on each base foot. This will keep the leg from moving sideways in mild weather conditions.



7. Measure out from the leg to a proper distance and secure the four anchors to ground at a 45 degree angle. Tie up one end of each guy(D)rope to the triangular shaped rope holder located on the outside fabric corners. Tie the other end of each rope to the anchor on the ground. Make sure the guy ropes have the proper tension.

THIS GAZEBO MUST BE SECURED TO THE GROUND WITH ANCHORS AND GUY ROPES.

⚠ WARNING

- Be careful to pinch hands or appendages during assembly.
- It is recommended that you use the ropes and stakes, and place some sandbags (E) at the bottom of each post to increase the stability of the tent.
- No-permanent structure. Do not use in inclement weather like heavy rain or wind.
- After folding the tent, please lay it flat to avoid falling down and hitting people.

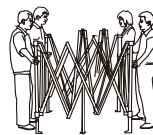

1. Stand frame (A) upright. Starting at the corners, with person standing on the opposite side, grasp the two outer legs, slightly lift the frame off the ground and step backward, stopping at full arms' length.

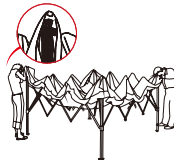

2. Place the Main Canopy (B) over the top frame. Use the Velcro pads to secure each corner of the canopy to the frame under the plastic leg caps.

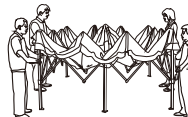

3. Each person should then grasp the bottom of the middle frame section (cross beams) where it forms diamond. Lift slightly and slowly walk backward until the frame is fully extended. Be careful not to pinch your finger or pull backward too hard as this may result in the bending of cross beams.

NOTE : MAKE SURE ALL 3 TOP CENTRAL TUBES WILL NOT BE STUCK WHILE LIFTING THE FRAME OFF THE GROUND.

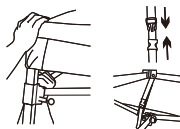

4. Engage the slider at each corner by pushing up the slider with one hand while holding down the top of the leg with the other hand. Repeat this at the rest of corners. Engage the buckle at the middle after going around the cross bar and adjust the ribbon for moderate tightness. Repeat this at the rest of middles.



5. Lift two adjacent outer legs and pull out inner legs gently until spring loaded snap button pops in position. Repeat on the other legs. The canopy offers two adjustable height levels through the use of pull rings. To adjust, lift the leg up, carefully pull out the small foot ring switch, then slowly pull out the inner tube until the snap button pops in next position. Repeat on the other leg.

CLOSE THE TENT

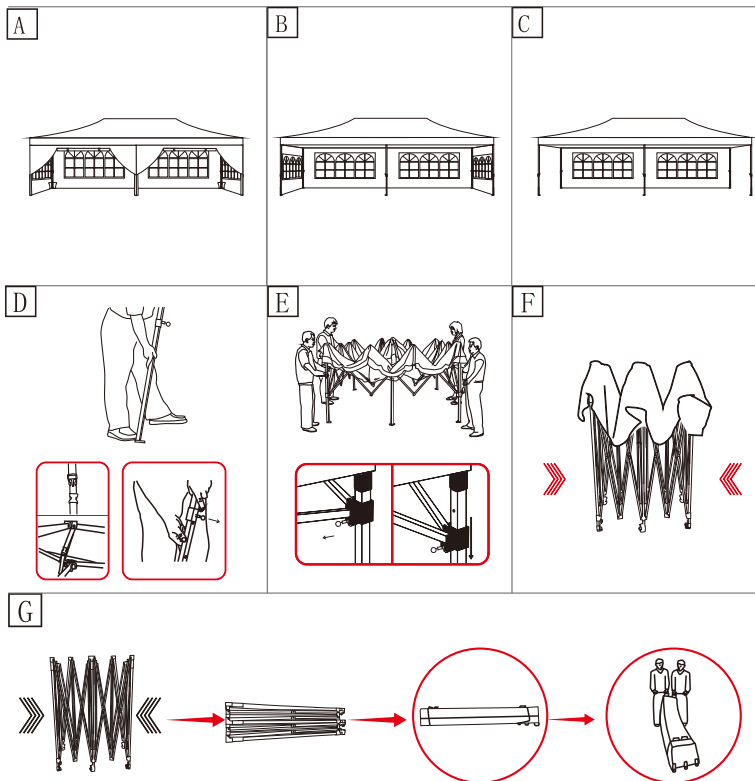

MADE IN CHINA