

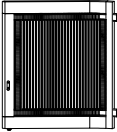

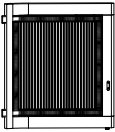

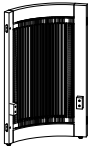

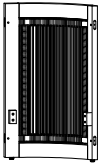

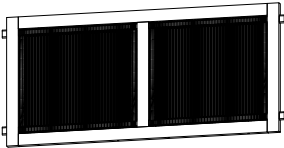

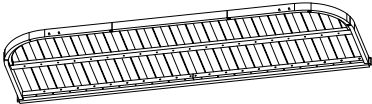
Hello! Please read these important attentions...

Please put a thick carpet on the ground to protect the furniture finish and corners. During the installation process, **DON' T** fasten screws tight 100% at a time.

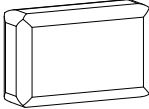
ASSEMBLY INSTRUCTIONS

NUMBER	COMPONENT	QUANTITY
A	 <p>LEG FRAME 1</p>	1PC
B	 <p>LEG FRAME 2</p>	1PC
C	 <p>LEG FRAME 3</p>	1PC
D	 <p>LEG FRAME 4</p>	1PC
E	 <p>LEG FRAME 5</p>	1PC
F	 <p>LEG EXTRA</p>	1PC
G	 <p>SEAT</p>	1PC

ASSEMBLY INSTRUCTIONS

NUMBER	COMPONENT	QUANTITY
H	 SEAT CUSHION	1PC
I	 BACK CUSHION	3PCS
J	 SCREW M7x70MM	4PCS
K	 SCREW M6x40MM	6PCS
L	 SCREW M4x20MM	8PCS
M	 PLASTIC LID	4PCS
N	 M4	2PCS

NOTE: The accessory pack does not include a screwdriver. Please prepare a screwdriver before you assemble.

ASSEMBLY INSTRUCTIONS

1

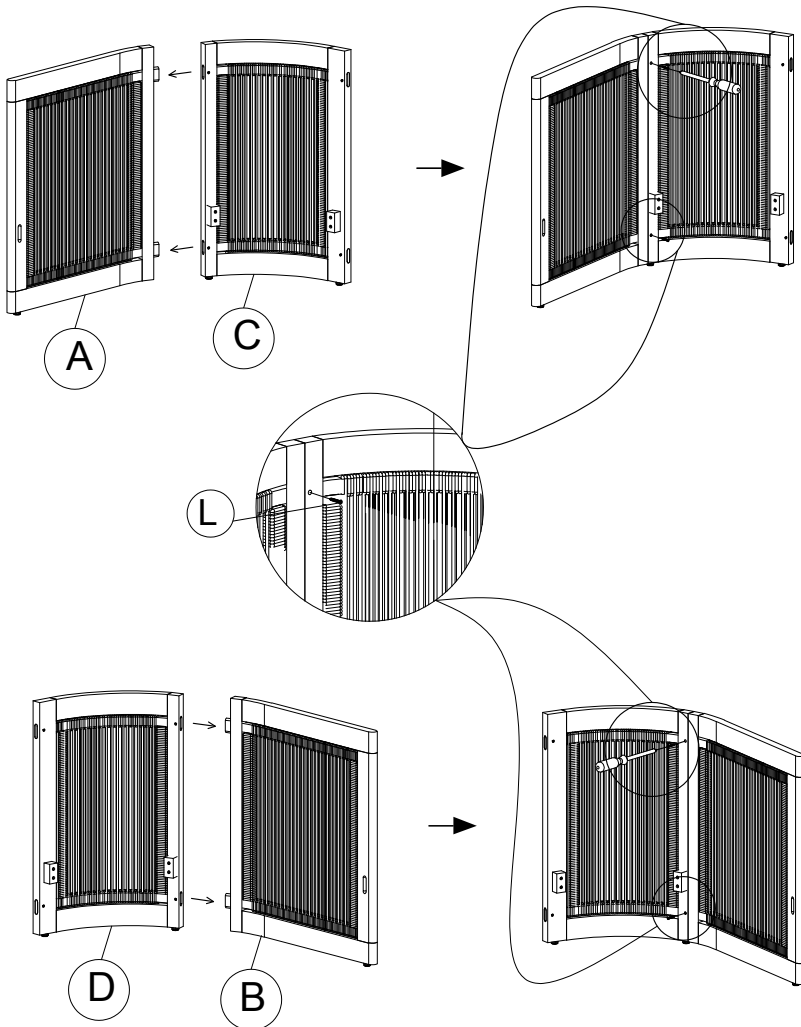

Use the Screws M4X20 MM (L) to connect the Leg Frame 1 (A) to the Leg Frame 3 (C) together to make the Right Leg Cluster.

Use the Screws M4X20 MM (L) to connect the Leg Frame 2 (B) to the Leg Frame 4 (D) together to make the Left Leg Cluster.

ASSEMBLY INSTRUCTIONS

2

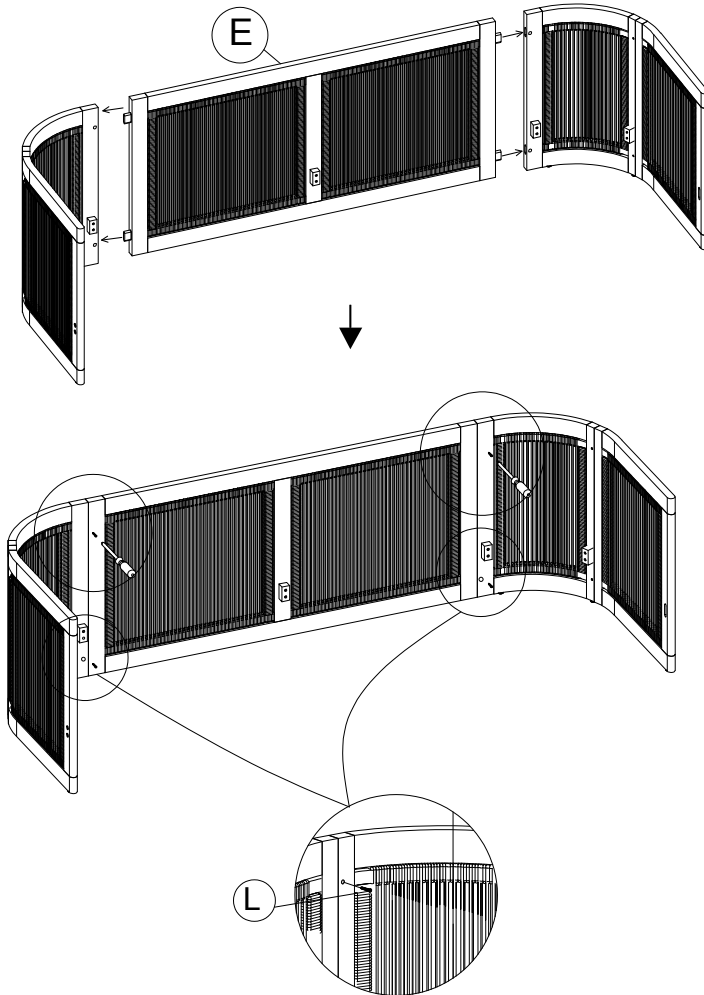

Use the Screws M4X20 MM (L) to connect the Right Leg Cluster and the Left Leg Cluster to the Leg Frame 5 (E) to create the Leg Cluster.

ASSEMBLY INSTRUCTIONS

3

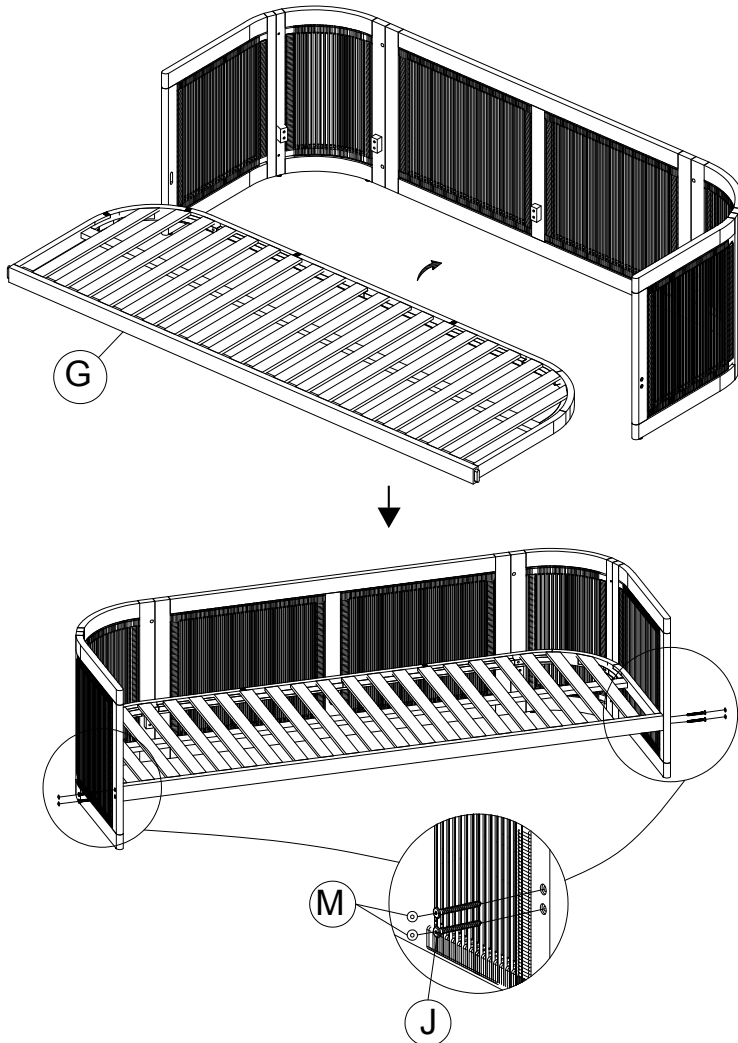

Use the Screws M7X70 MM (J) to connect the Leg Cluster to the Seat in 2 sides.

ASSEMBLY INSTRUCTIONS

4

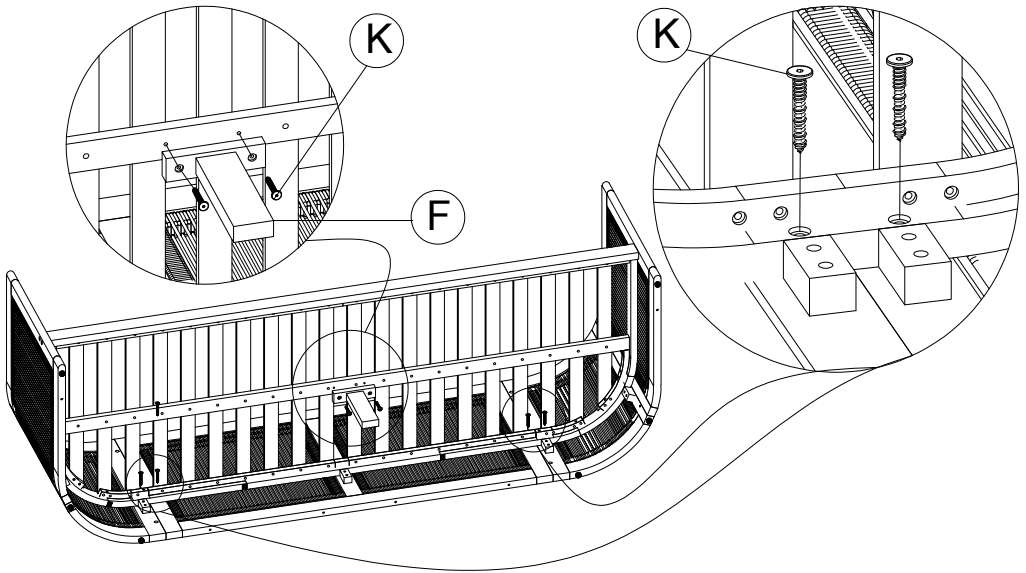

Use the Screws M6X40 MM (K) to tighten the Leg Cluster to the Seat (G)

And use the Screws M6X40 MM (K) to connect the Leg Extra (F) to the Seat (G).

ASSEMBLY INSTRUCTIONS

5

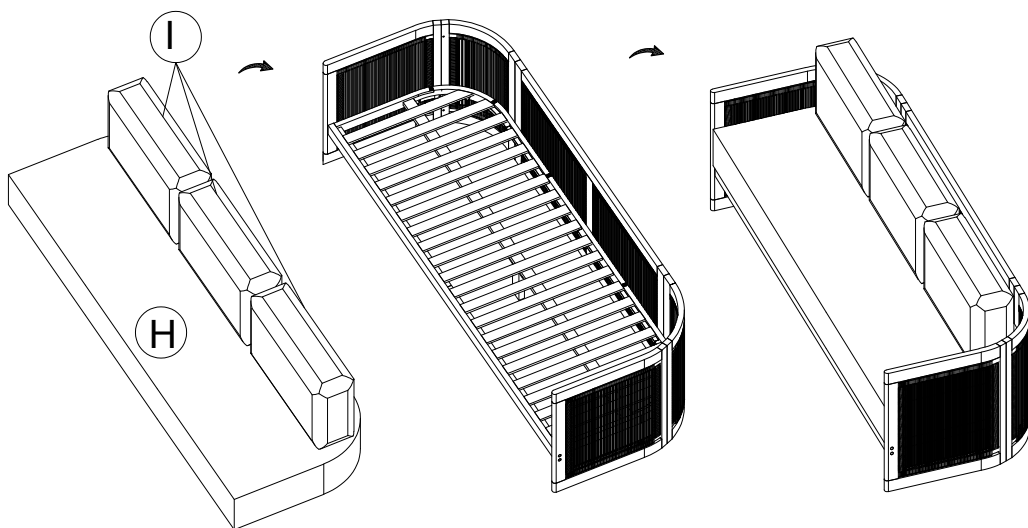

Put the Back and Seat Cushion on the Sofa.

ASSEMBLY INSTRUCTIONS

6

