

Assembly Instructions

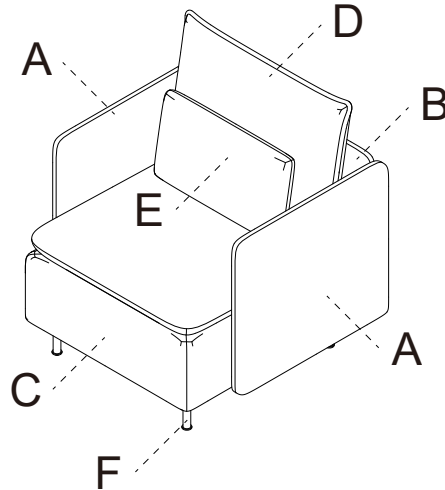

Assemble on the pad to prevent scratching the product.
Do not tighten all screws before instructions prompt.



Parts List

Open the hardware check all parts QTY, thanks

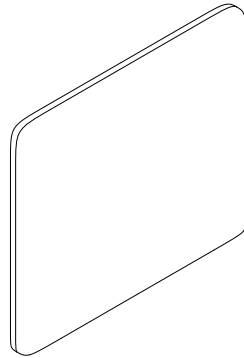

A x 2
(Armrest)

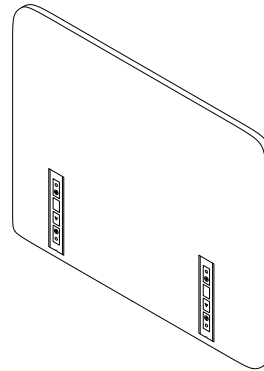

B x 1
(Back)

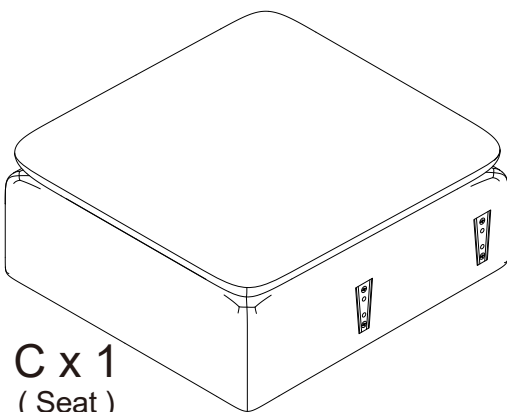

C x 1
(Seat)

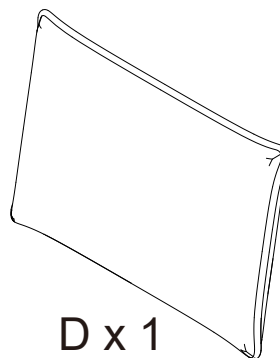

D x 1
(Back Cushion)

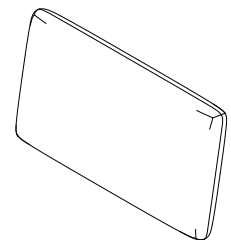

E x 1
(Pillow)

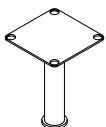

F x 4
(Legs)



G x 16
(Screws)



H x 1
(Wrench, tighten clockwise)

Step 1

Open the velcro on bottom of "C".
Take out "A", "D", "E", "F", "G", "H".

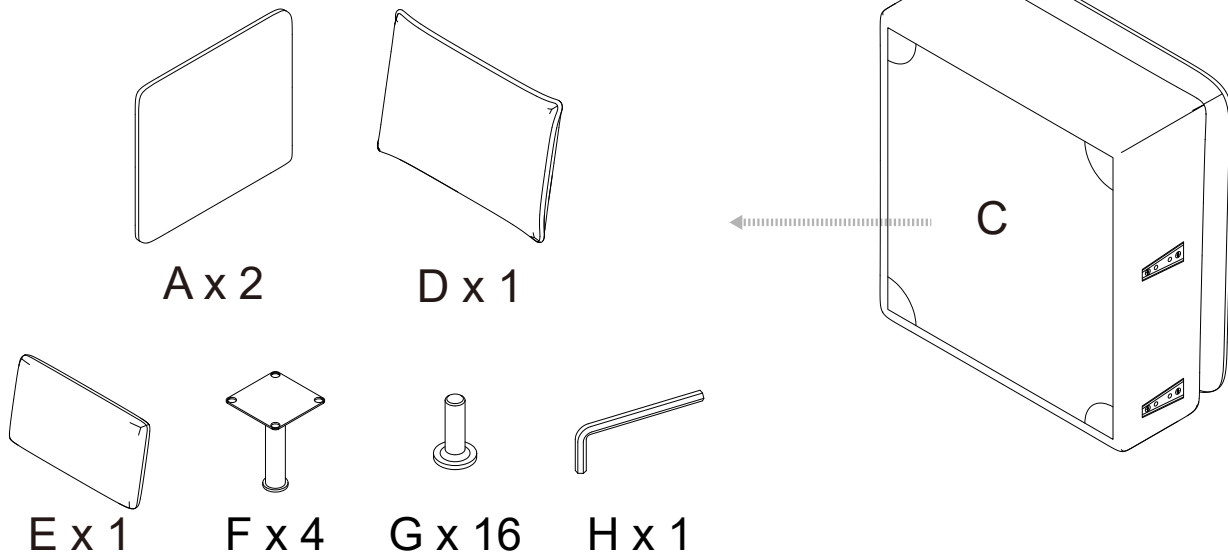

Step 2

First the four screws screwing in, then tighten clockwise.
Close the velcro on bottom of "C".

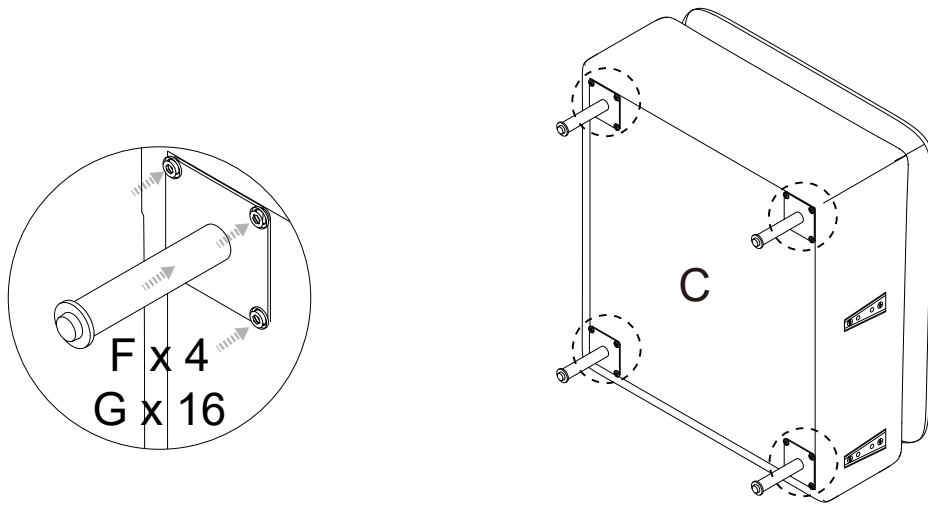

Step 3

Press "B" inserting pieces into "C" slots.
Press "A" inserting pieces into "C" slots.
Place the "D", "E".

