

Installation & Assembly

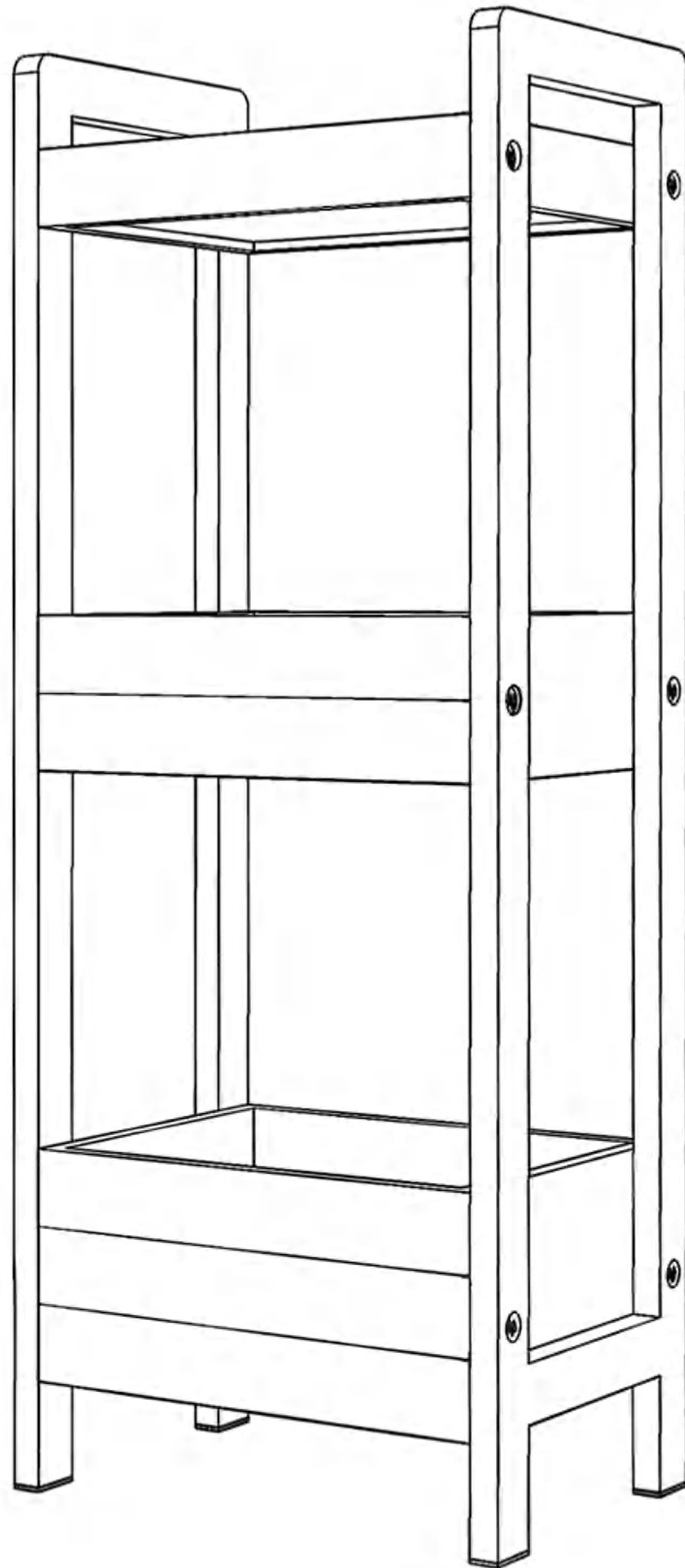

TOOLS:



1

X
2



2

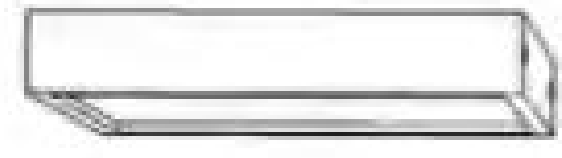

3

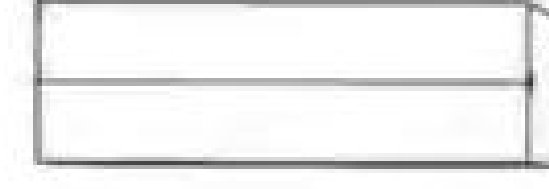

4

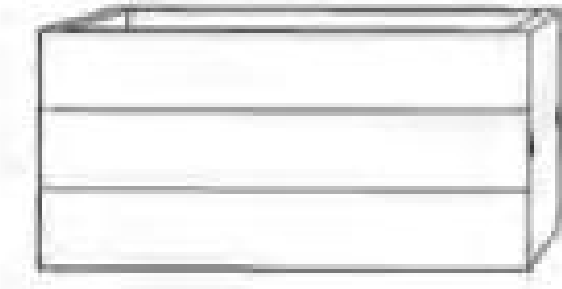

UNIT:MM

A

X
12



M6. 5*22

B

X
4

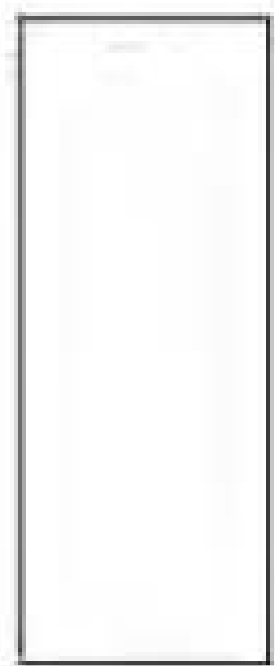

30*15

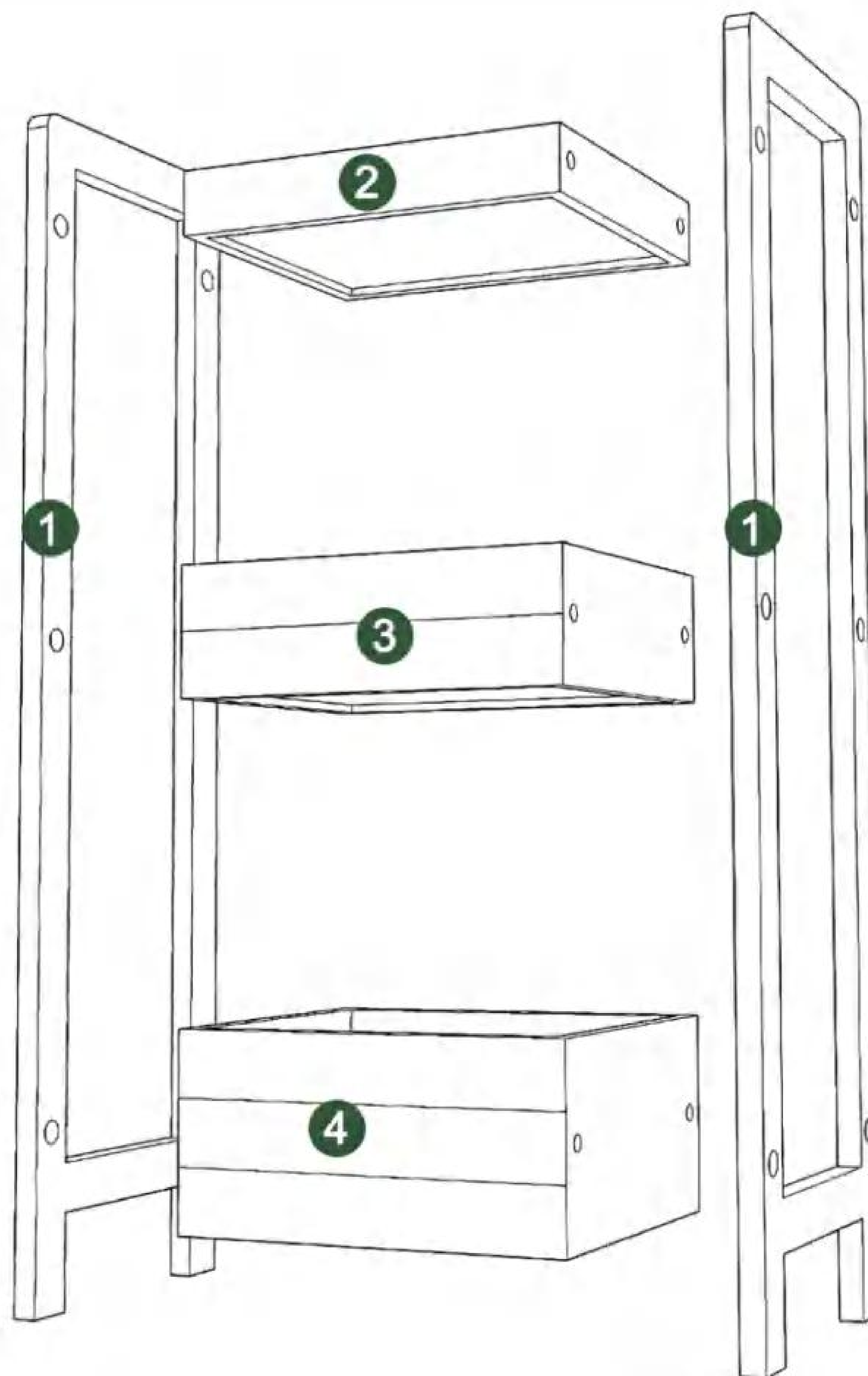

1.

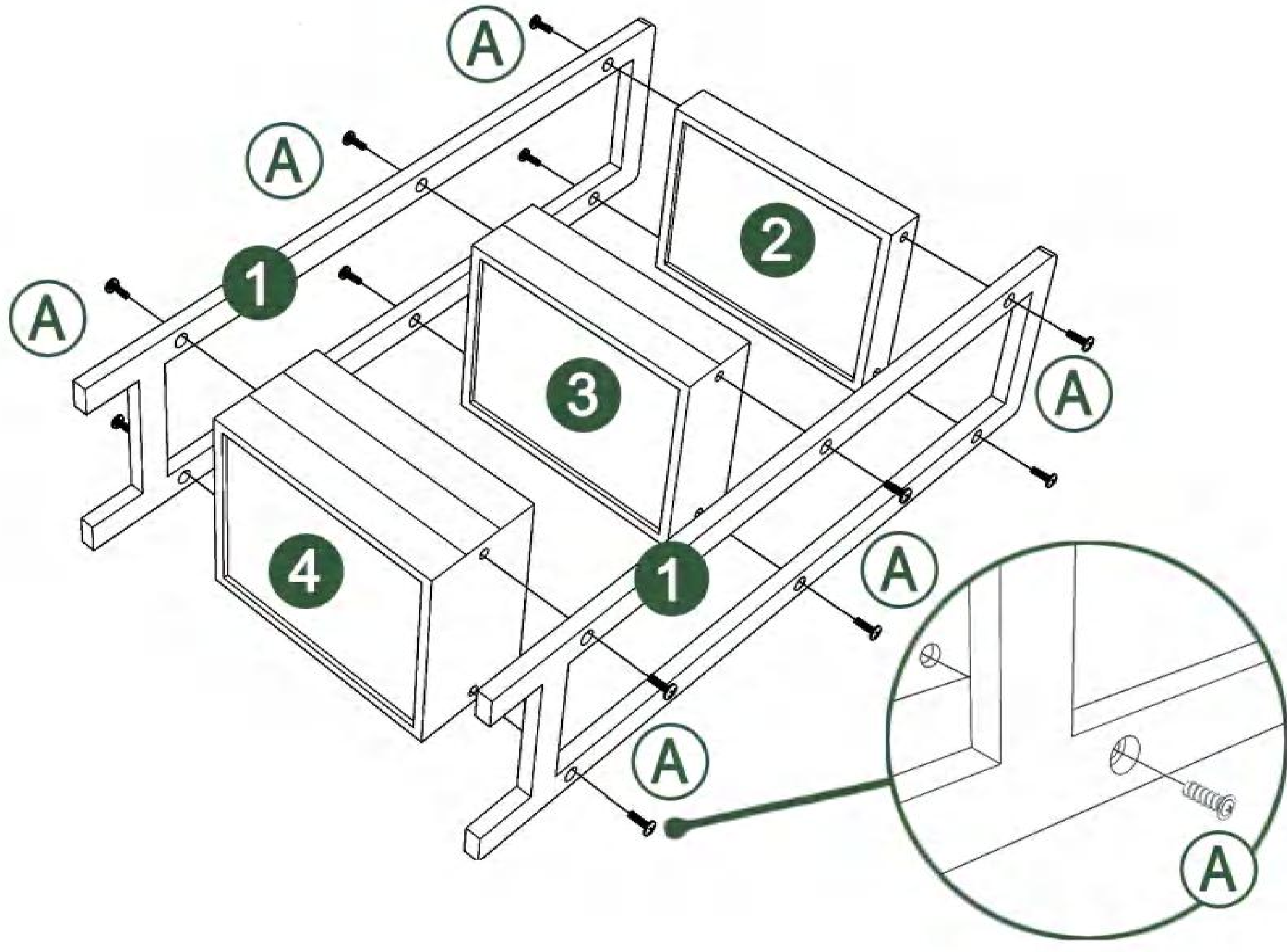

2.

