

ASSEMBLY INSTRUCTION

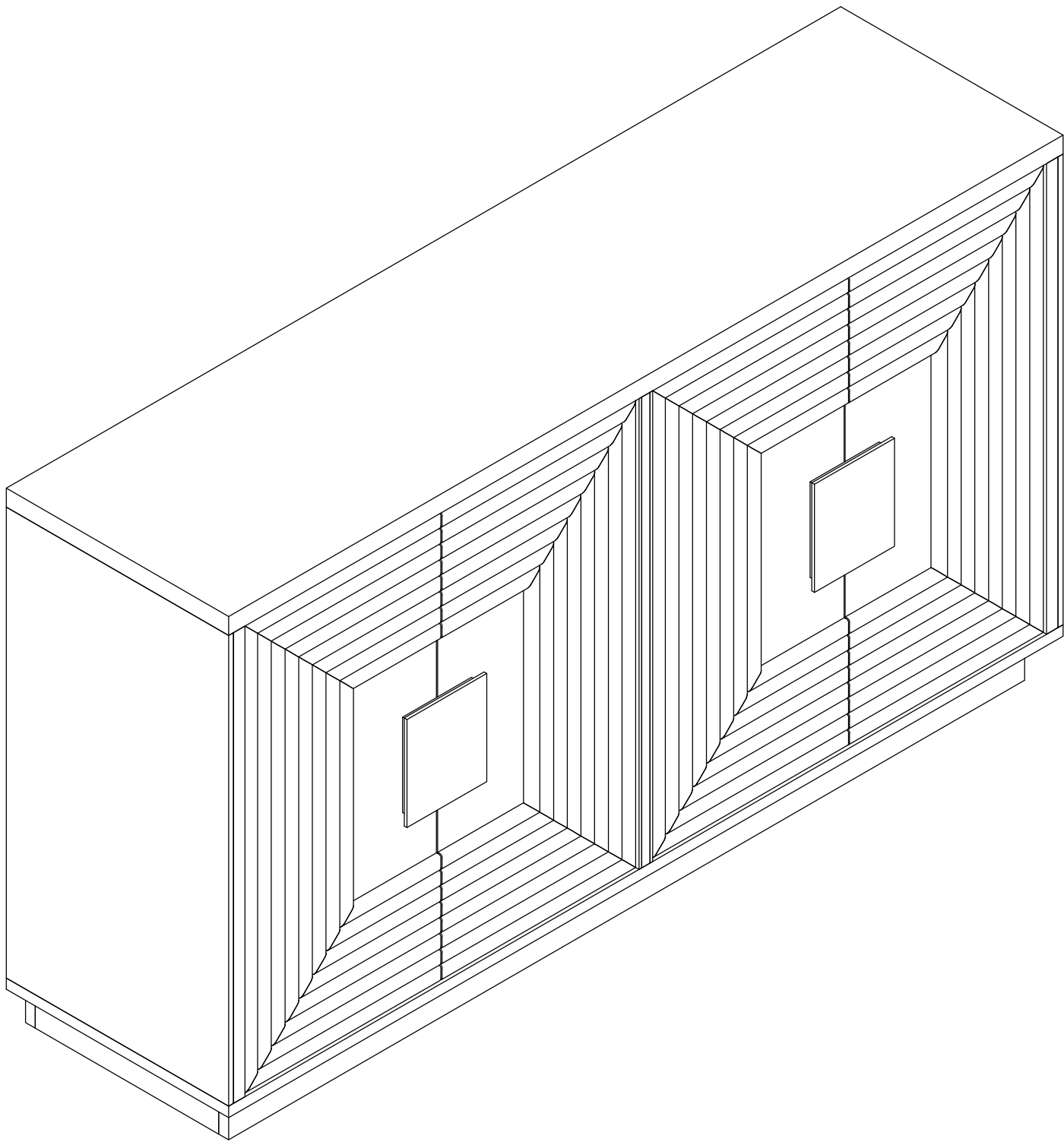

ASSEMBLY INSTRUCTION

Please read these instructions fully before starting assembly:

Tools required: Phillips screwdriver (medium & large)

- 1: Check you have all the components and tools listed on the following pages.
- 2: Remove all fittings from the plastic bags and separate them into their groups.
- 3: Keep children and animals away from the work area, small parts could choke if swallowed.
- 4: Make sure you have enough space to layout the parts before starting.
- 5: During assembly do not stand or put weight on the product, this could cause damage.
- 6: Assemble the item as close to its final position (in the same room) as possible.
- 7: Assemble on a soft level surface to avoid damaging the unit or your floor.
- 8: Parts of the assembly will be easier with 2 people.
- 9: To reduce the likelihood of damaging your product please ensure that your power drill is set on a low torque setting.
- 10: Assemble all parts and bolts loosely during assembly, only once the product is complete should you fully tighten the bolts.
- 11: Regularly check and ensure That all bolts and fittings are tightend properly.
- 12: Please do not place items that exceed the load capacity.







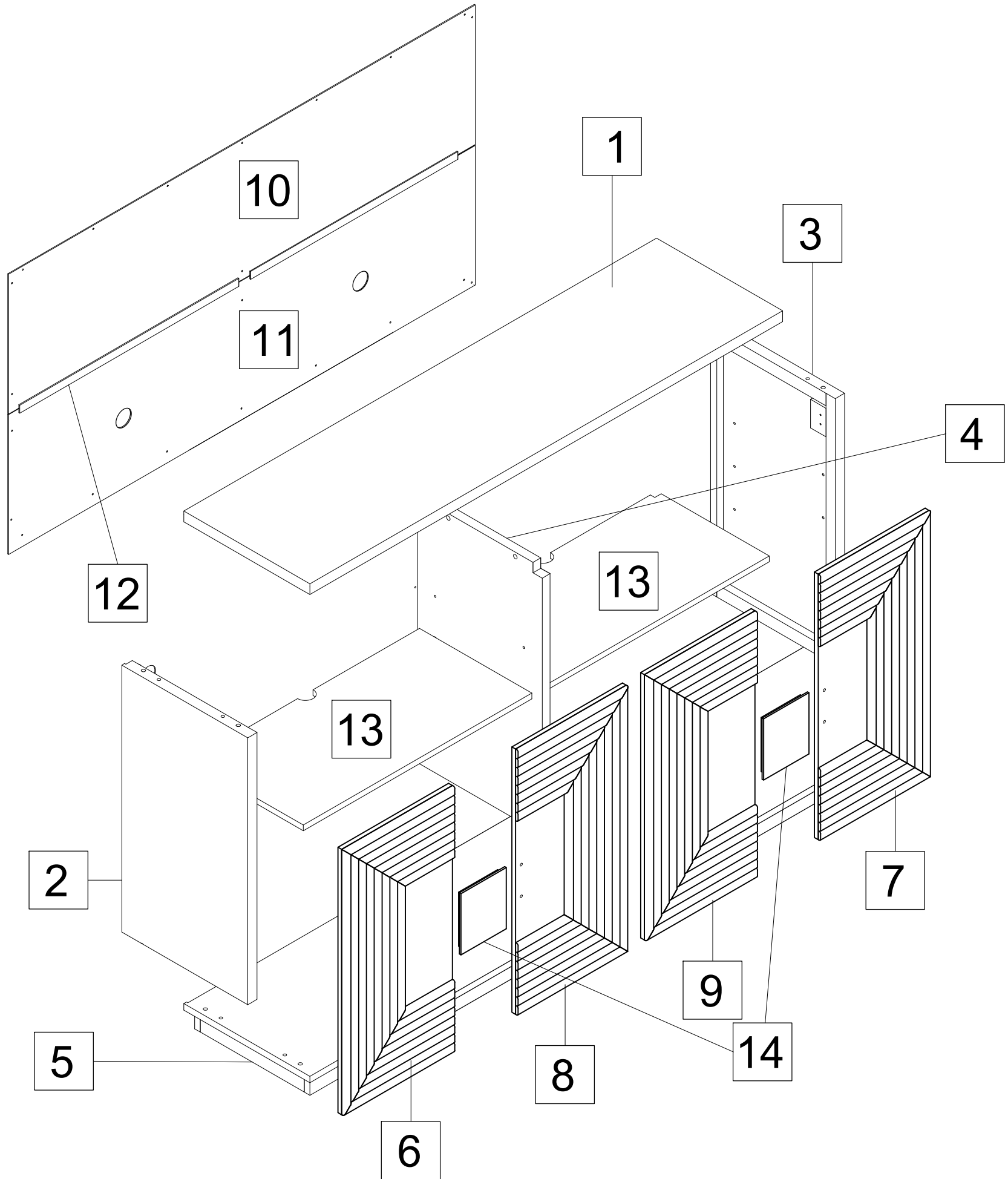

Care and maintenance:

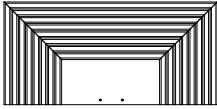
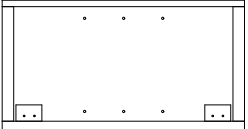
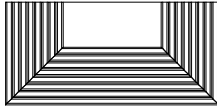
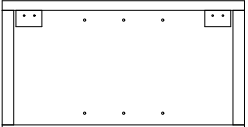
Only clean using a damp cloth and mild detergent, do no use bleach or abrasive cleaners.

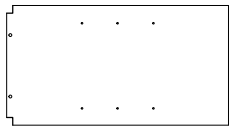



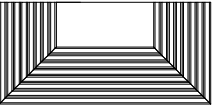

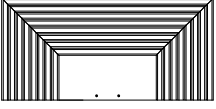
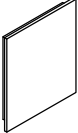

PRODUCT DETAILS

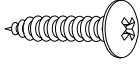
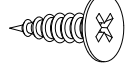
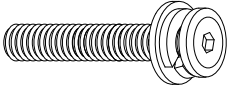
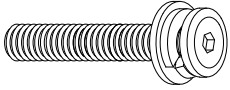

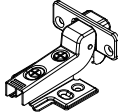
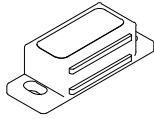
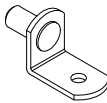
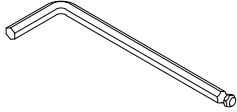
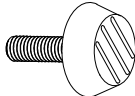
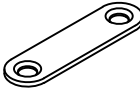
PART LIST

1	Top Panel 	1pc	8	Center Door frame (left) 	1pc
2	Side Frame (Left) 	1pc	9	Center Door frame (right) 	1pc
3	Side Frame (Right) 	1pc	10	Back Panel 1 	1pc
4	Parition Panel 	1pc	11	Back Panel 2 	1pc
5	Base Frame 	1pc	12	Center rail 	2pcs
6	Side Door frame (left) 	1pc	13	Shefl Frame 	2pcs
7	Side Door frame (right) 	1pc	14	Door handle 	2pcs

HARDWARE LIST

<p>A</p>  <p style="text-align: center;">Ø8x30mm</p> <p>Wood dowel (10pcs)</p>	<p>B</p>  <p style="text-align: center;">M4x15mm</p> <p>Wood screw (24pcs)</p>	<p>C</p>  <p style="text-align: center;">M3.5x15mm</p> <p>Wood screw (72pcs)</p>		
<p>D</p>  <p style="text-align: center;">1/4x55mm</p> <p>Bolt (4pcs)</p>	<p>E</p>  <p style="text-align: center;">1/4x40mm</p> <p>Bolt (8pcs)</p>	<p>F</p>  <p style="text-align: center;">M4x25mm</p> <p>Handle bolts (4pcs)</p>		
<p>G</p>  <p style="text-align: center;">5/8</p> <p>Soft close hinges (8pcs)</p>	<p>H</p>  <p style="text-align: center;">Door magnet (4pcs)</p>	<p>K</p>  <p style="text-align: center;">Pin shelf (8pcs)</p>		
<p>L</p>  <p style="text-align: center;">1/4</p> <p>Hexagonal lock (1pc)</p>	<p>M</p>  <p style="text-align: center;">1/4x25mm</p> <p>Leveler (5pcs)</p>	<p>I</p>  <p style="text-align: center;">Magnetic foil (4pcs)</p>		
<p>N Anti Tip Kit 2 sets</p>				
<p>N1</p>  <p>Plastic Bracket (4pcs)</p>	<p>N2</p>  <p>Restraint Strap (2pcs)</p>	<p>N3</p>  <p>Phillips Screws M4 x 40mm (4pcs)</p>	<p>N4</p>  <p>Phillips Screws M4 x 15mm (4pcs)</p>	<p>N5</p>  <p>Plastic Anchor (4pcs)</p>

ASSEMBLY TOOLS REQUIRED (NOT INCLUDED)

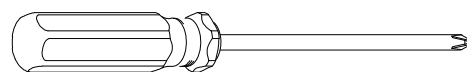

Step 1

A

Ø8x30mm
Wood dowel

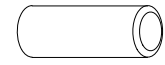

4pcs

C

M3.5x15mm
Wood screw

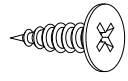

8pcs

H

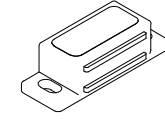

Door magnet

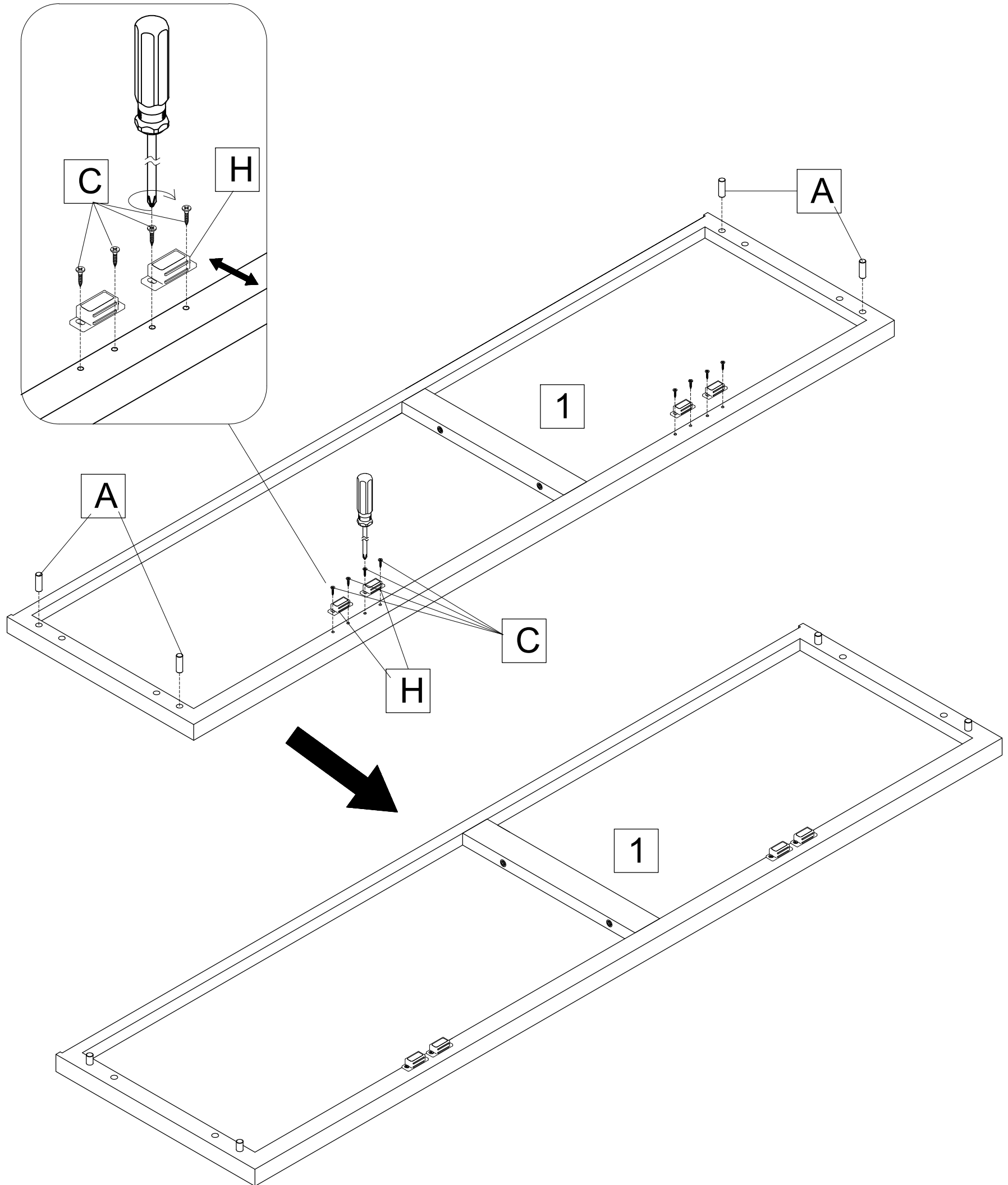

4pcs



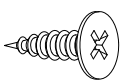

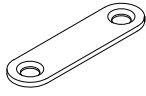
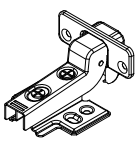
Step 2

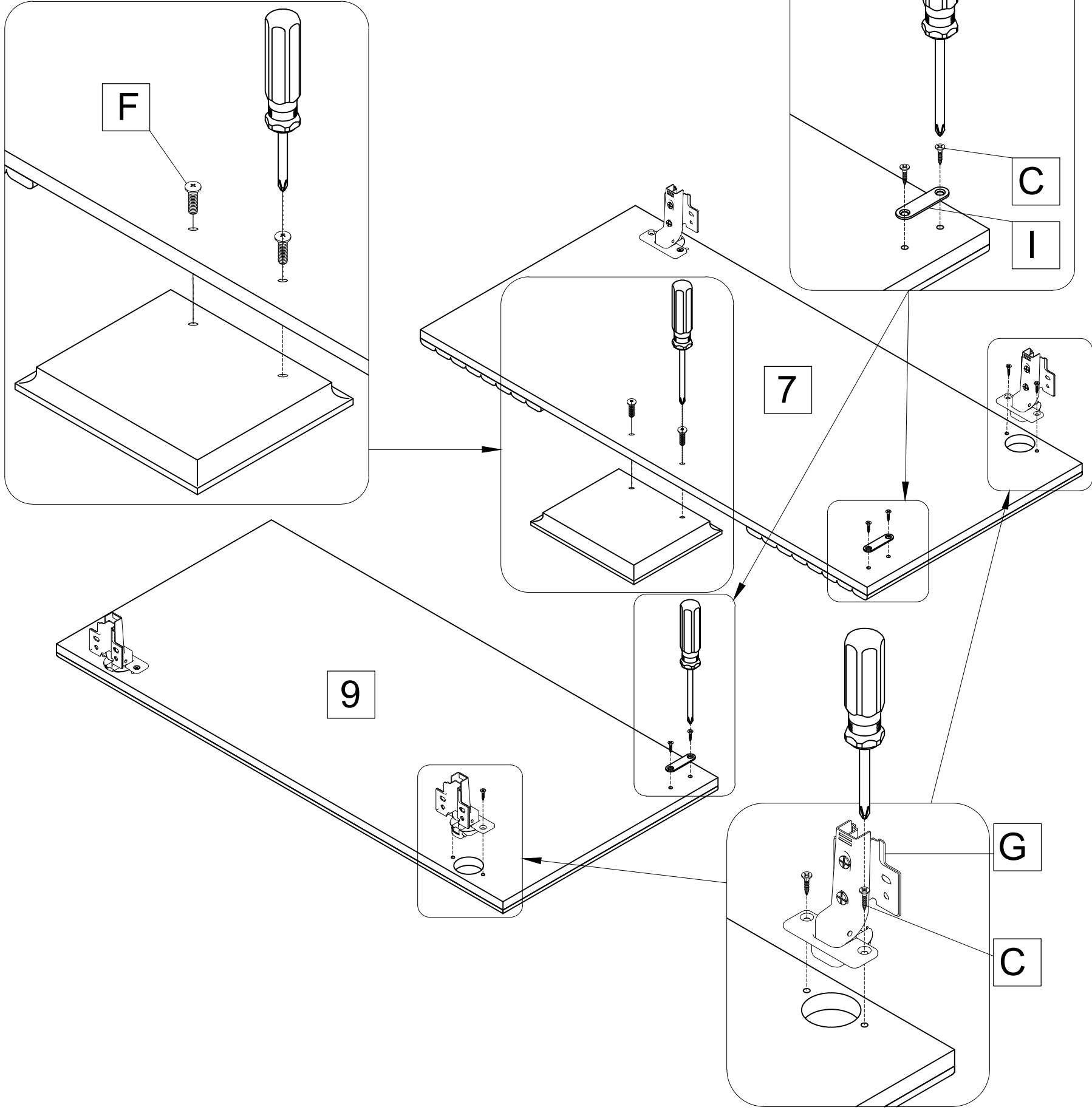
<p>C</p>	<p>M3.5x15mm Wood screw</p> 	<p>12pcs</p>	<p>F</p>	<p>1/4x25mm Handle bolts</p> 	<p>2pcs</p>
<p>I</p>	<p>Magnetic foil (4pcs)</p> 	<p>2pcs</p>	<p>G</p>	<p>Soft close hinges</p> 	<p>4pcs</p>

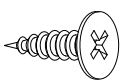

Step 3

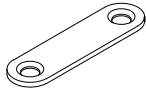
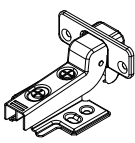
<p>C</p>	<p>M3.5x15mm Wood screw</p> 	<p>12pcs</p>	<p>F</p>	<p>1/4x25mm Handle bolts</p> 	<p>2pcs</p>
<p>I</p>	<p>Magnetic foil (4pcs)</p> 	<p>2pcs</p>	<p>G</p>	<p>Soft close hinges</p> 	<p>4pcs</p>

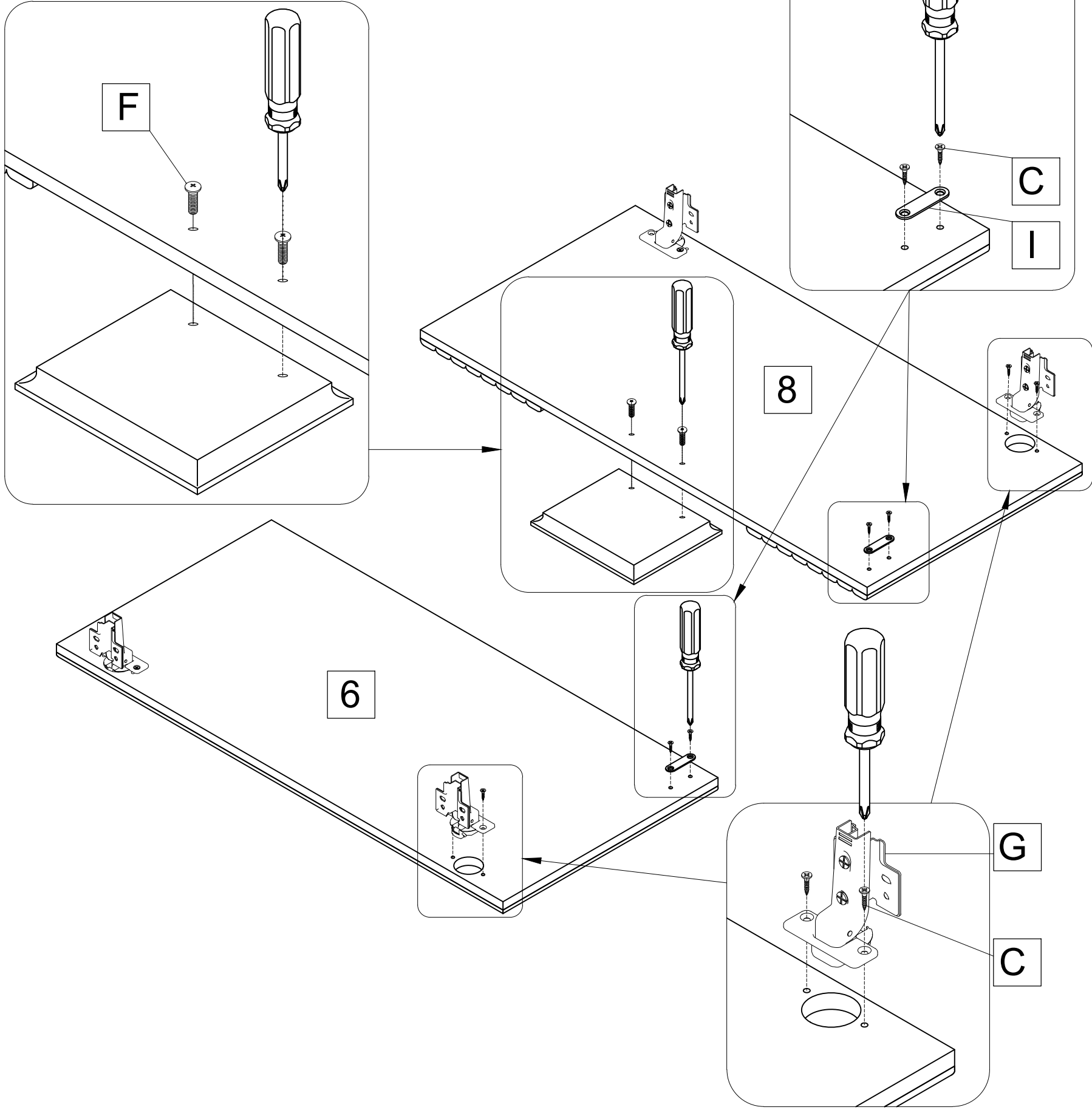

Step 4

D

1/4x55mm
Bolt

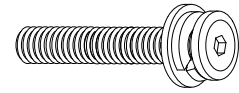

4pcs

E

1/4x40mm
Bolt

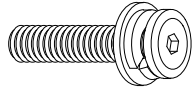

2pcs

L

Hexagonal lock

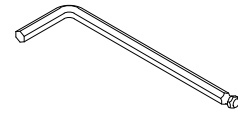

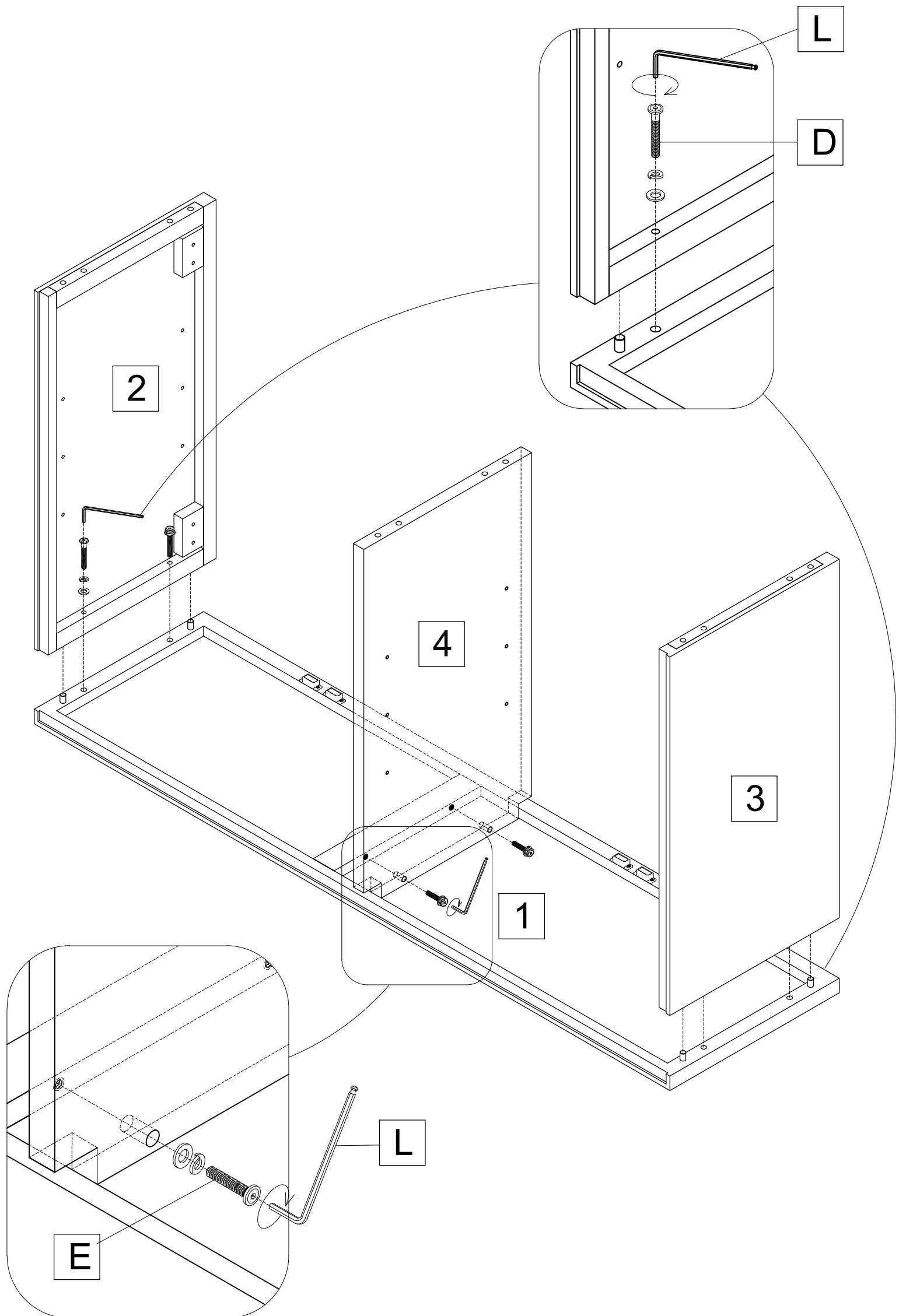

1pc

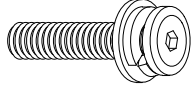
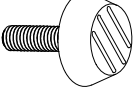

Step 5

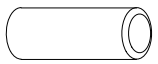
E	1/4x40mm Bolt		6pcs
M	1/4x25mm Leveler		5pcs

A	Ø8x30mm Wood dowel		6pcs
L	Hexagonal lock		1pc

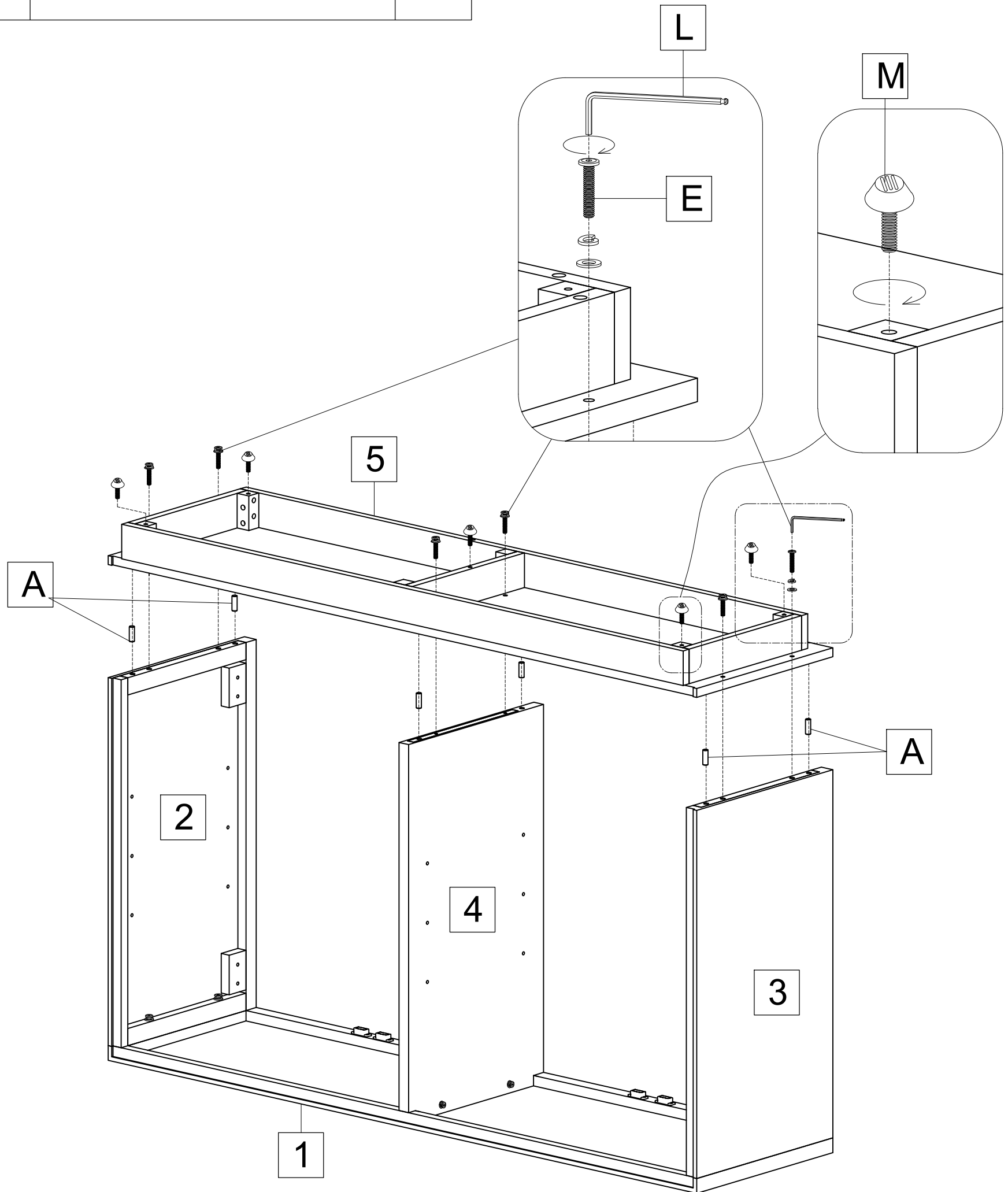

Step 6

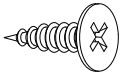
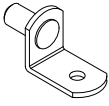
C	M3.5x15mm Wood screw		8pcs
K	Pin shelf		8pcs

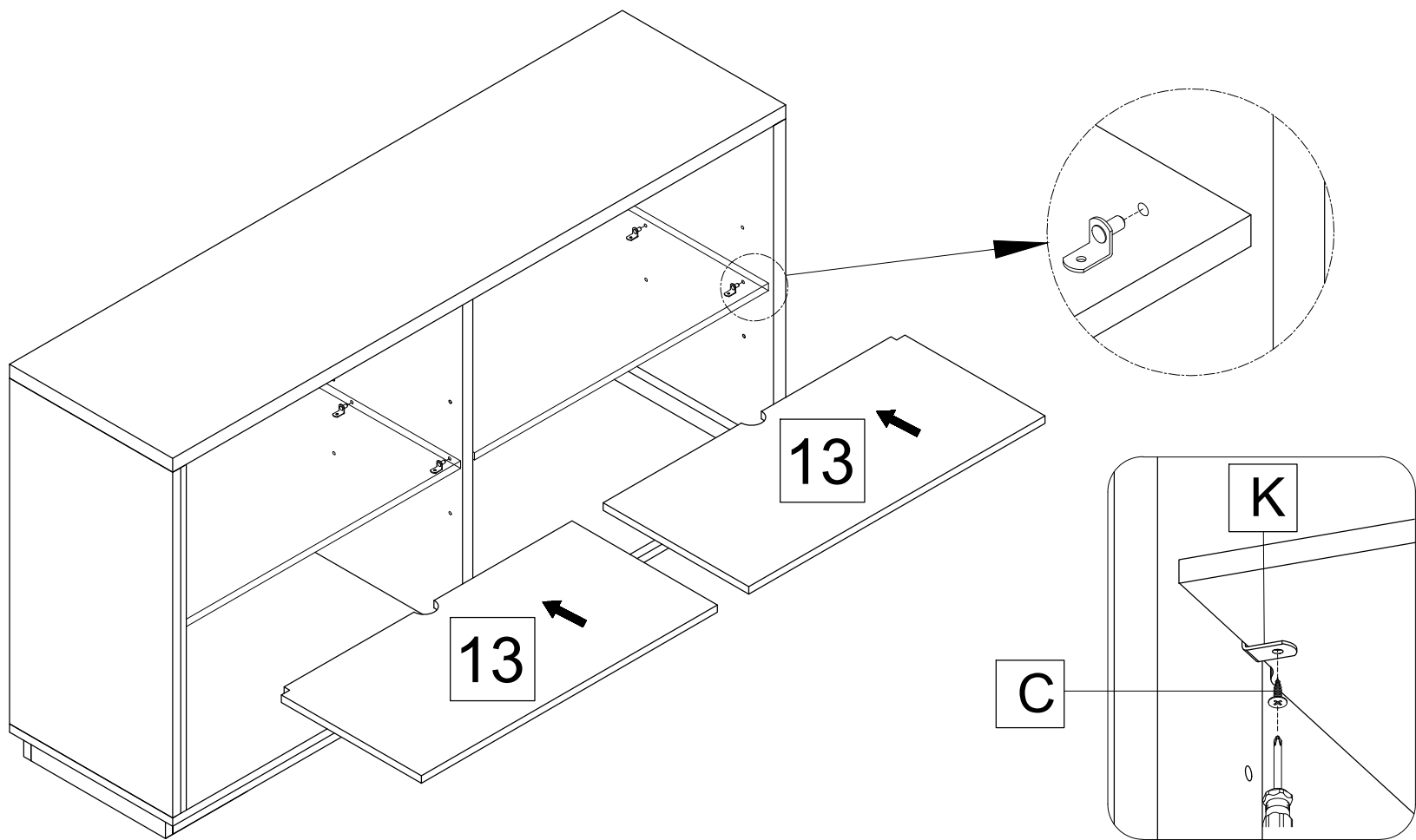

Step 7

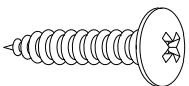
B	M4x15mm Wood screw		24pcs
---	-----------------------	---	-------

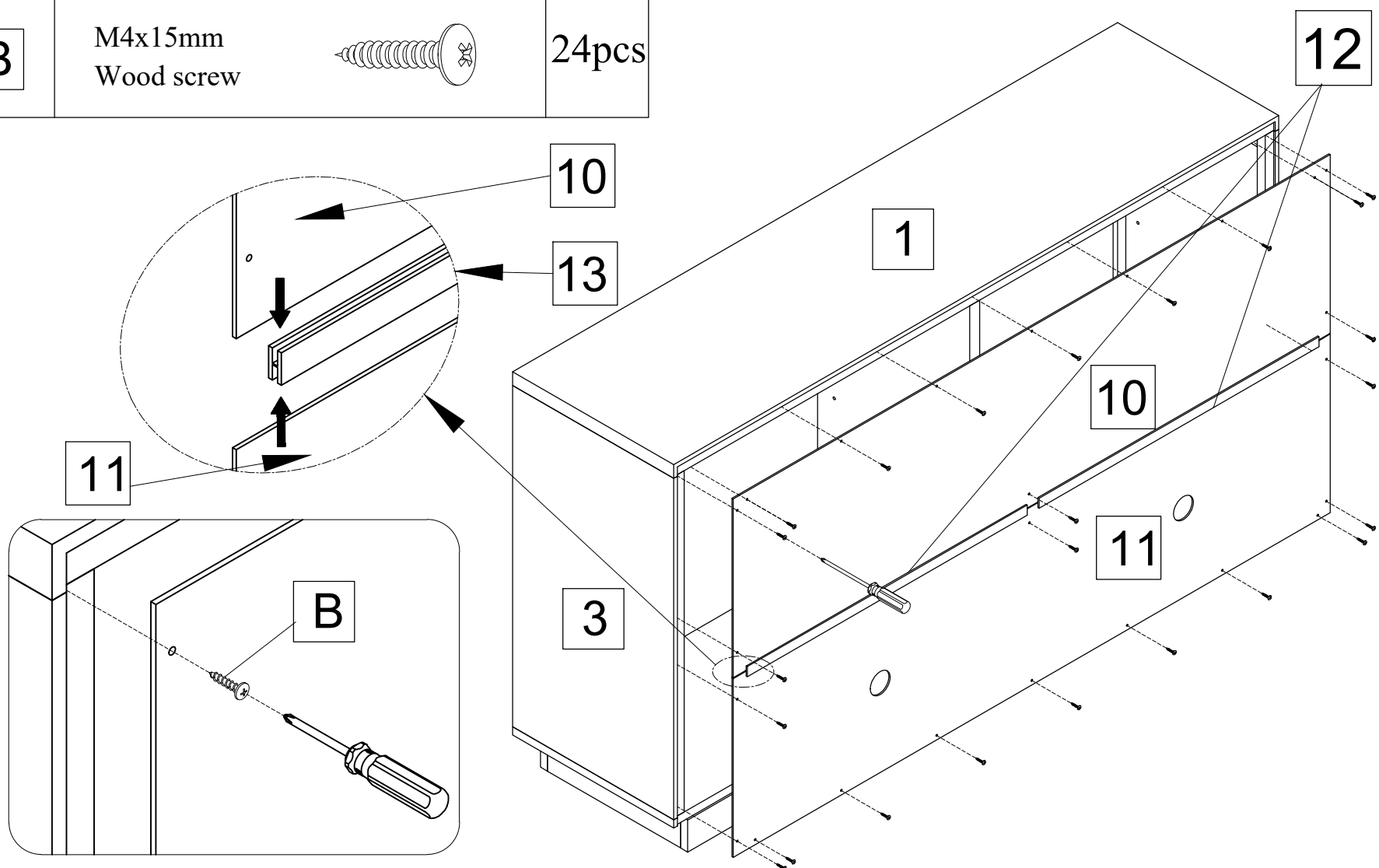

Step 8

C

M3.5x15mm
Wood screw

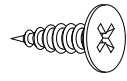

32pcs

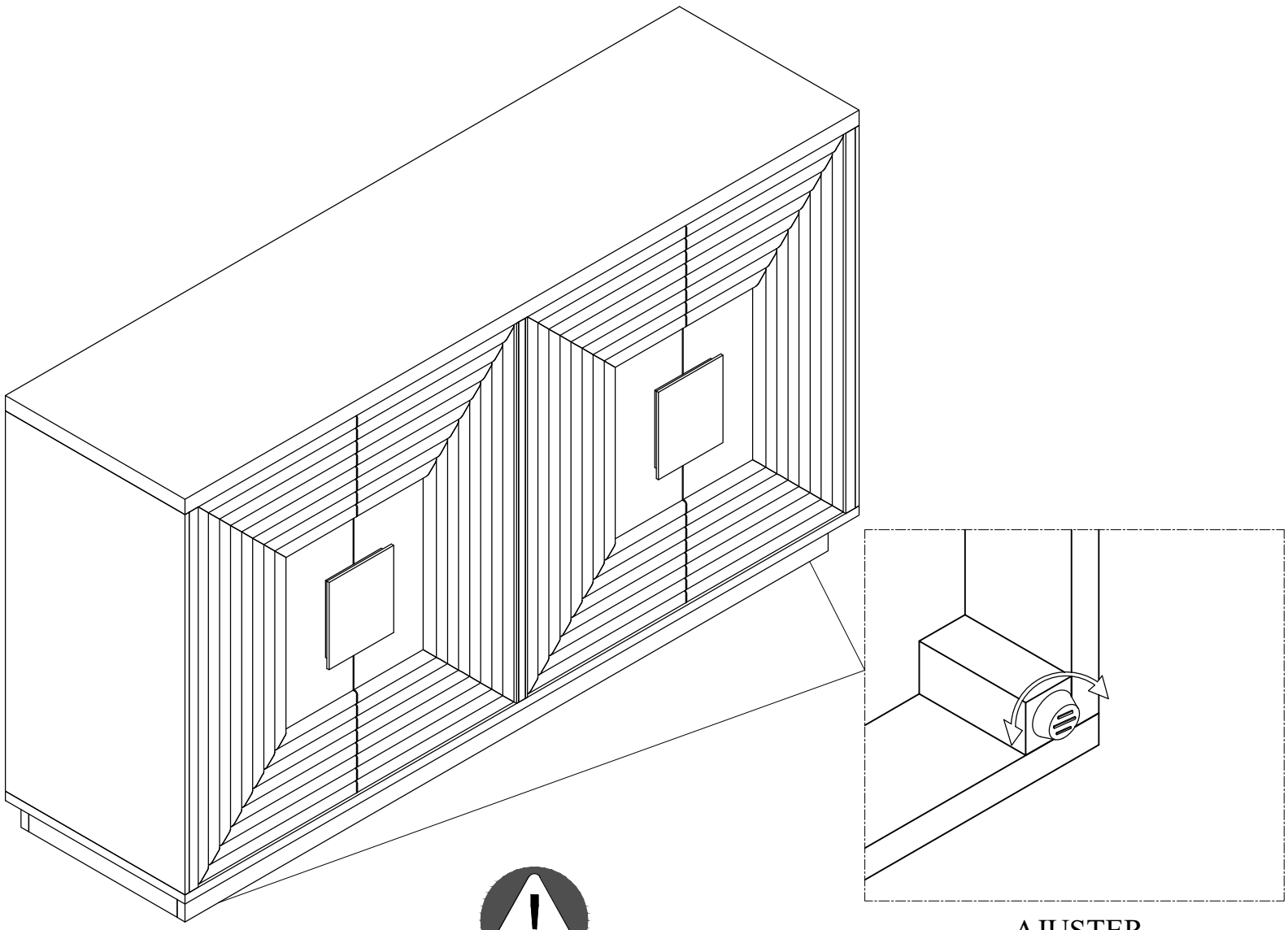
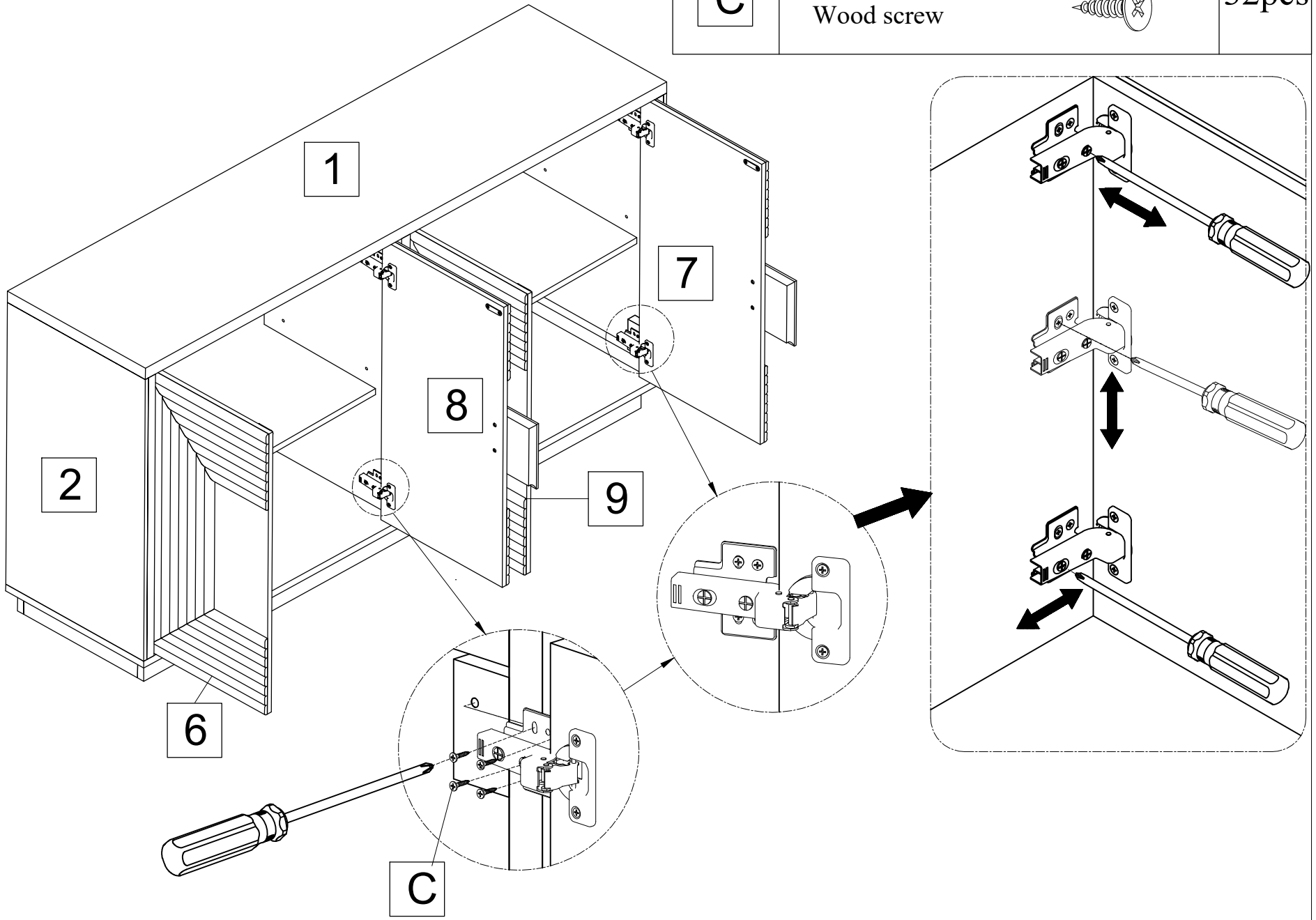





Note: After moving your unit to its final location, you may need to adjust the floor levelers.

PLASTIC ANTI-TIP-KIT INSTRUCTIONS

FURNITURE TIPPING RESTRAINT INSTRUCTIONS

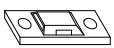
Young children may be injured by tipping furniture and the use of a tipping restraint is highly recommended. When properly installed, this restraint could provide protection against the unexpected tipping of furniture due to small tremors, bumps or climbing. We recommend mounting this restraint to a wall stud.

WARNING: This product is only a deterrent. It is not a substitute for proper adult supervision.

N1	N2	N3	N4	N5
				
(4pcs)	(2pcs)	(4pcs)	(4pcs)	(4pcs)
Nx2				

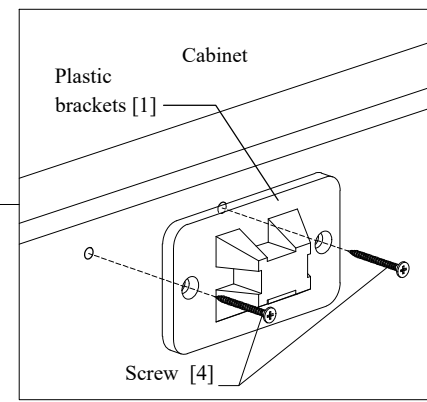
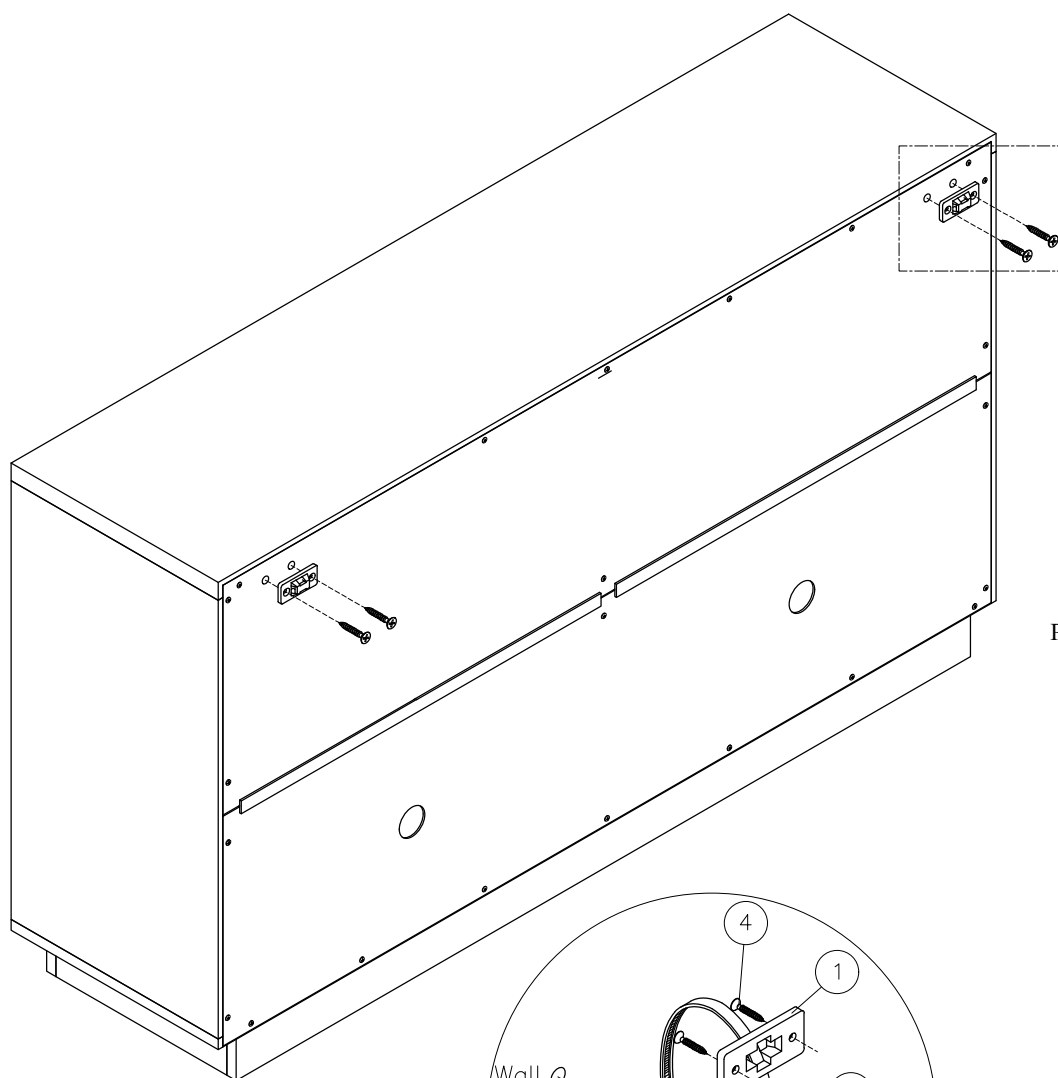

FIGURE 01

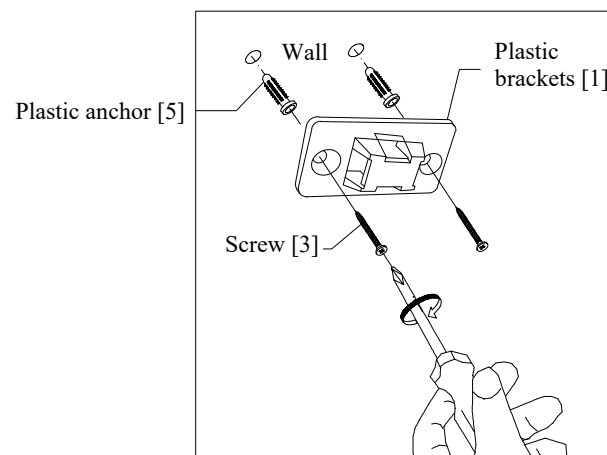

FIGURE 02

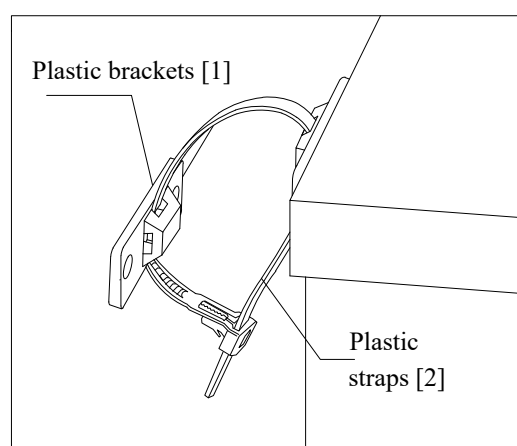
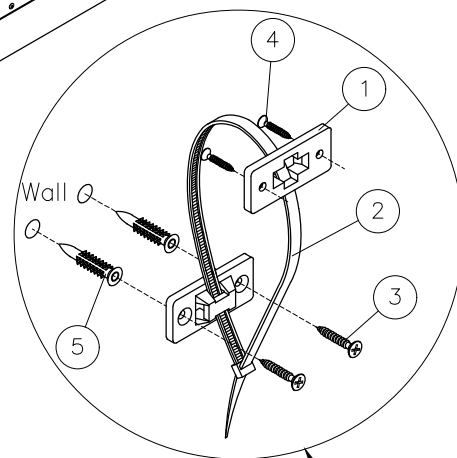
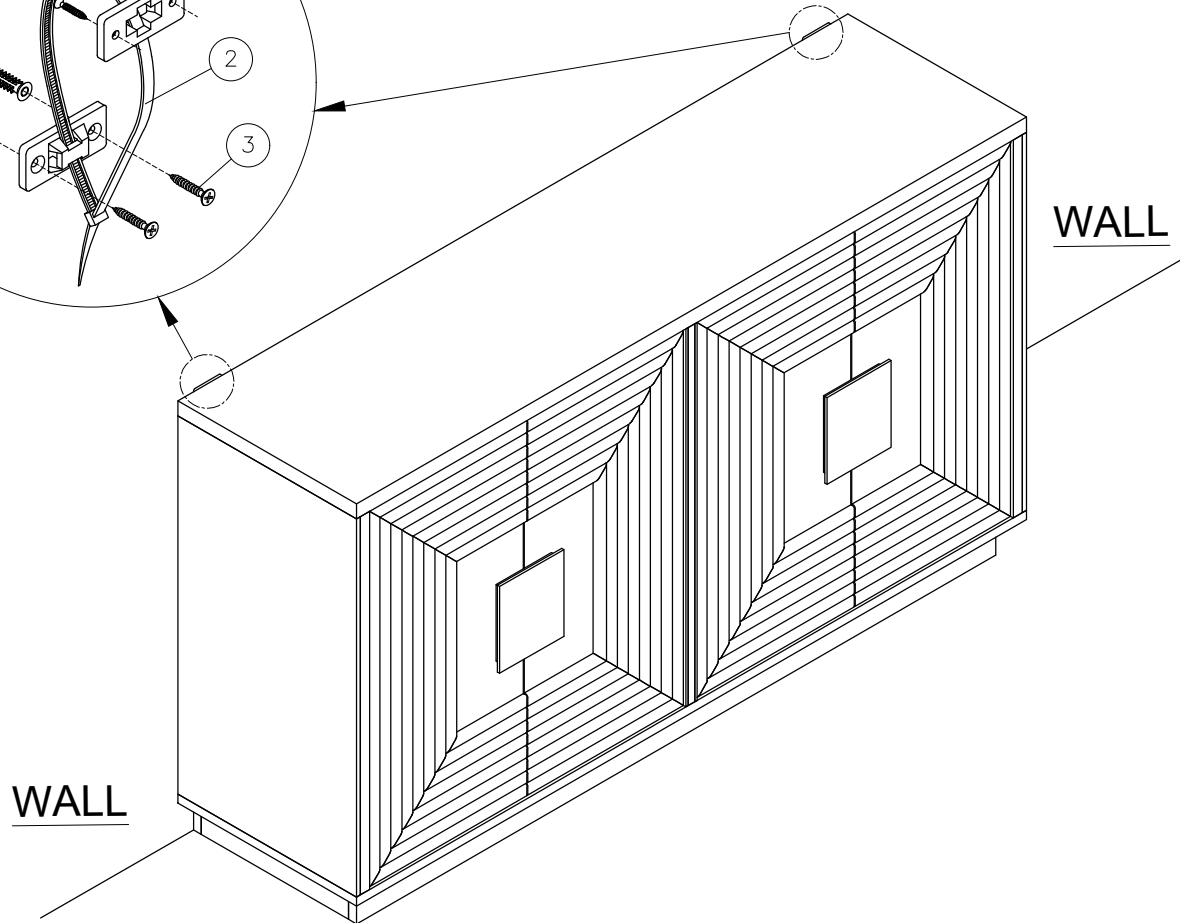
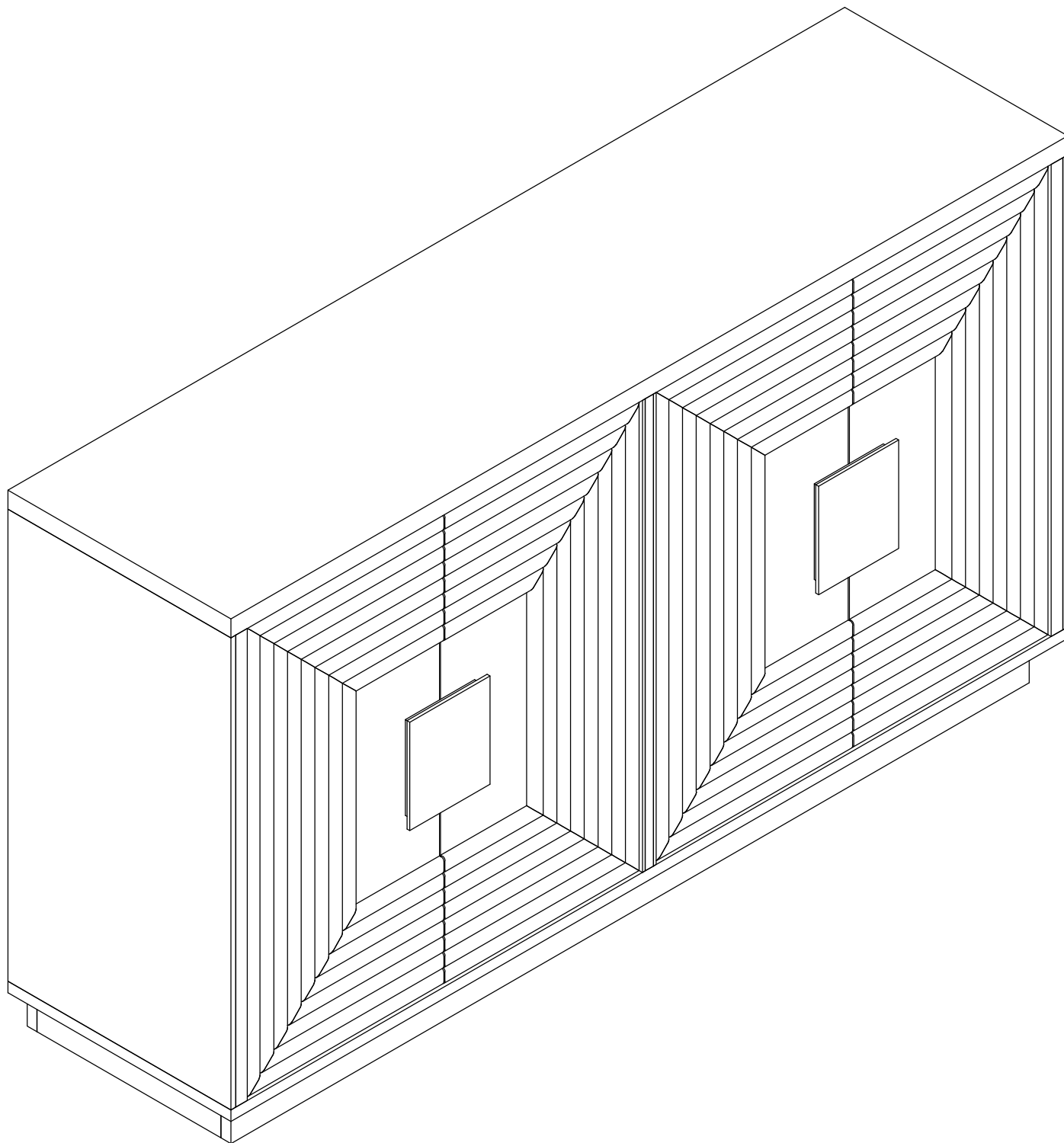

FIGURE 03





ASSEMBLY IS COMPLETE