

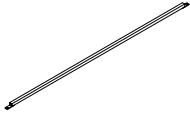

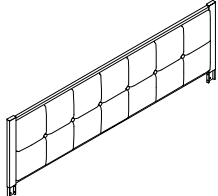

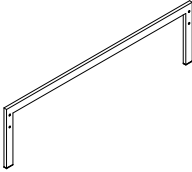

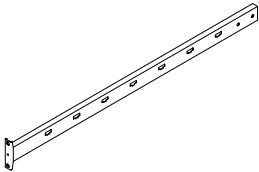

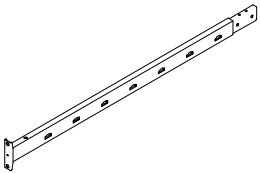
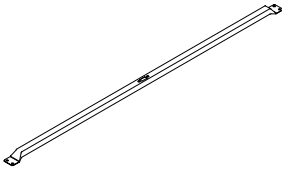
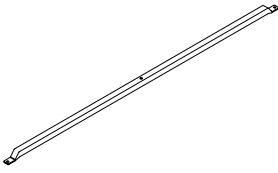
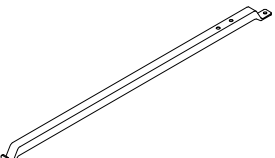

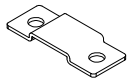

ASSEMBLY INSTRUCTION

METAL QUEEN BED

A Headboard Stretcher	B Headboard	C Footboard	D Front Side Rail
			
1PC E Rear Side Rail	1PC F Center Cross Bar	1PC G Side Cross Bar	2PCS H Center Rail
			
2PCS I Center Support Leg	1PC J Support Leg	2PCS K Slat	2PCS L Slat Connector
			
3PCS M Left Leg	2PCS N Right Leg	14PCS O Bracket 65 x 25 x 2mm	28PCS P Bolt 1/4" x 22mm
			
1PC Q Bolt 5/16" x 19mm	1PC R Bolt 1/4" x 17.5mm	1PC S Bolt 1/4" x 40mm	26PCS T Nut 1/4"
			
8PCS	4PCS	4PCS	4PCS

U Ratchet Tool
4mm

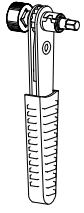

1PC

V Wrench
1/4" x 5/16"

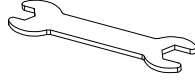

1PC

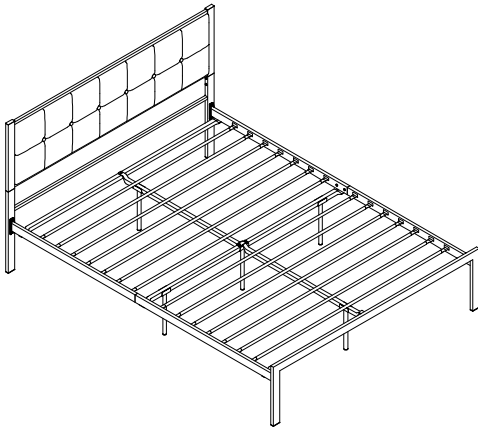

These pages list all the contents included in the box. Please take the time to identify the hardware as well as the individual components to this product. As you unpack and prepare for assembly, place the contents on a carpeted or padded area to protect them from damage.

How to Use the Ratchet Tool (U)

1. Before assembling the furniture, please adjust the lock as needed.

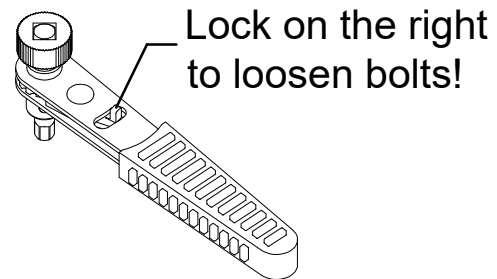
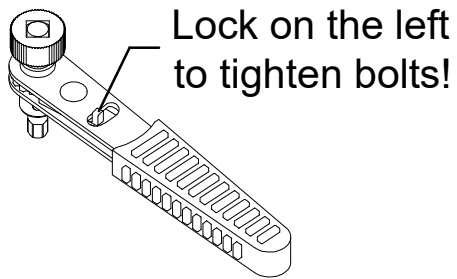

2. Tighten or loosen bolts.

- **Tighten bolts:** Locate the turncap and rotate it clockwise to screw the bolt quickly until it cannot be rotated any more. Then start rotating the handle clockwise to finalize tightening the bolt.

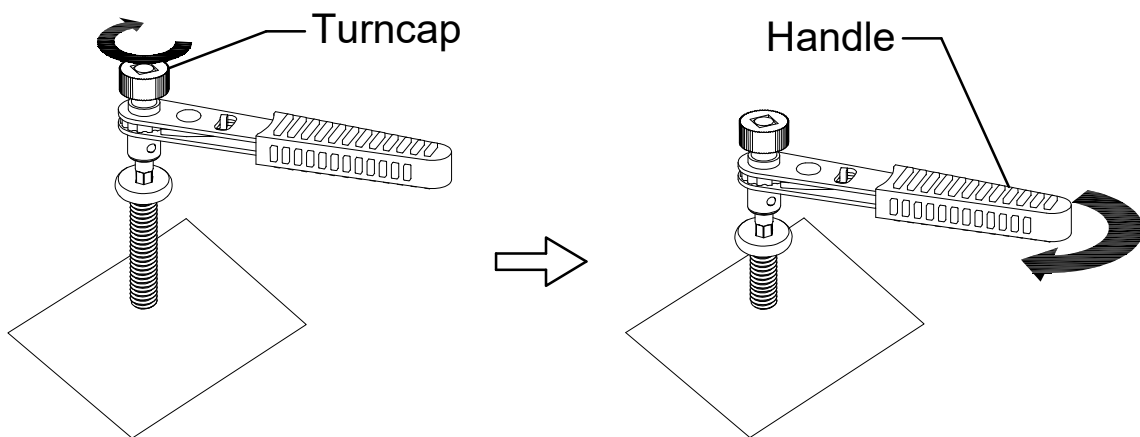

- **Loosen bolts:** Rotate the handle counterclockwise to loosen the bolt. Then continue rotating the turncap in the same direction to remove the bolt completely.

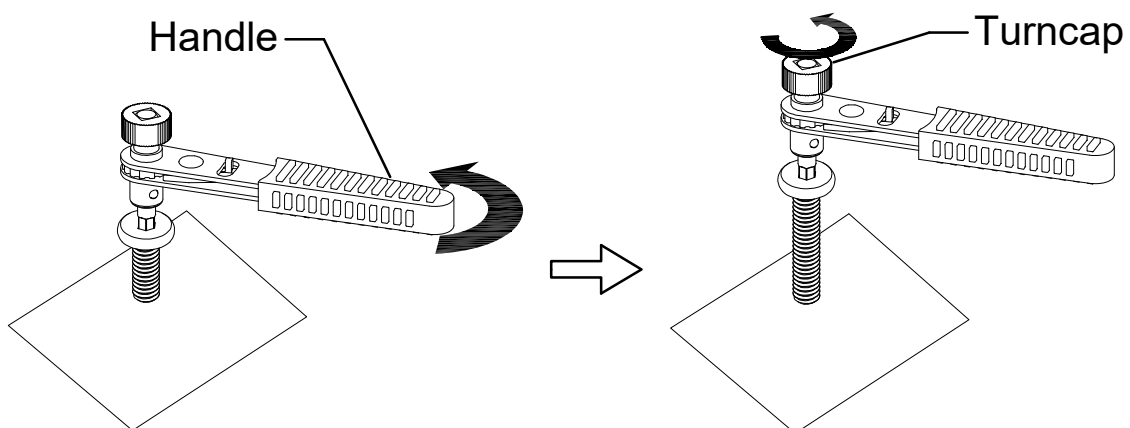

1

Attach the Left Leg (M) and Right Leg (N) to Headboard (B), insert the Bolt (P), turn the Ratchet Tool (U) to tighten them.

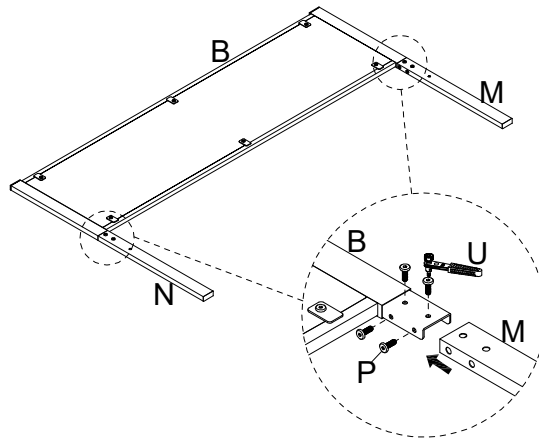
**2**

Attach the Headboard Stretcher (A) to Left Leg (M) and Right Leg (N), insert the Bolt (P), turn the Ratchet Tool (U) to tighten them.

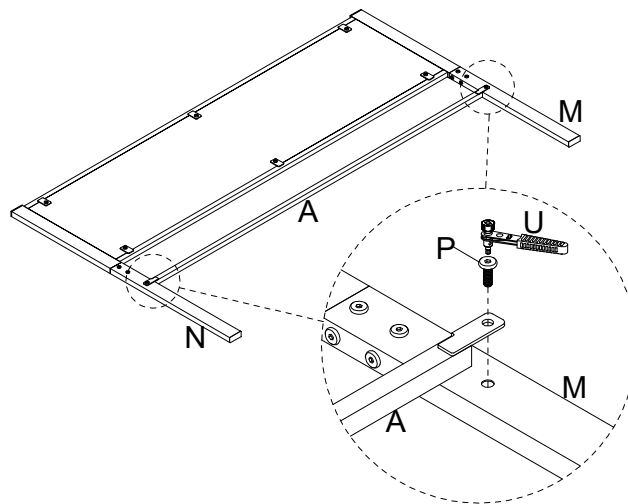
**3**

Attach the Rear Side Rail (E) to Front Side Rail (D), insert the Bolt (R), turn the Ratchet Tool (U) to tighten them.

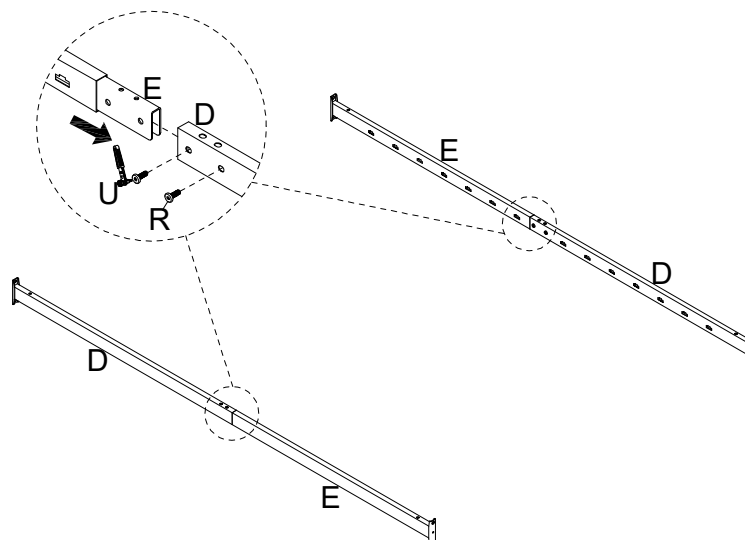

4

Attach the Side Cross Bar (G) and Center Cross Bar (F) to Side Rails (D & E), insert the Bolt (P), turn the Ratchet Tool (U) to tighten them.

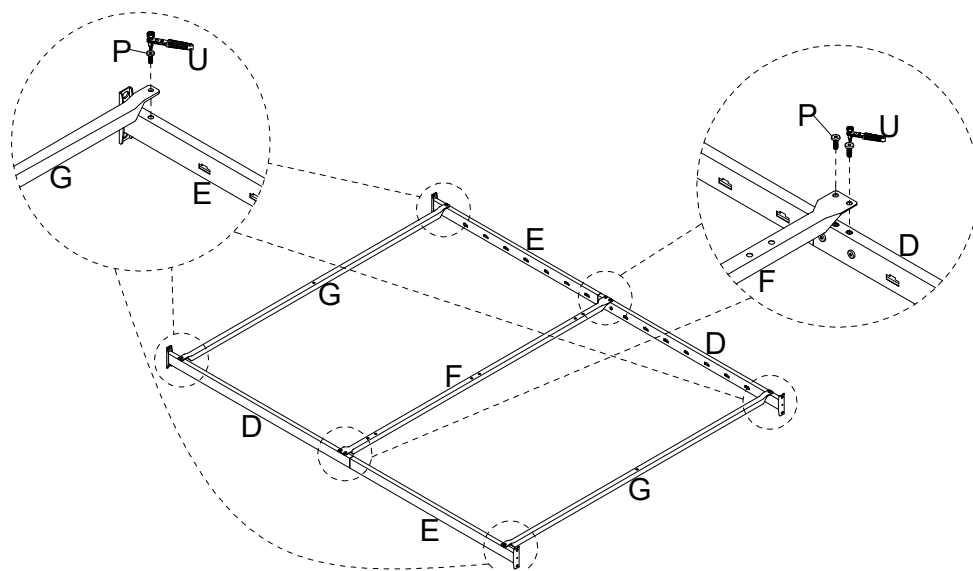
**5**

Attach the Center Support Leg (I) to Center Cross Bar (F), insert the Bolt (P), turn the Ratchet Tool (U) to tighten them.

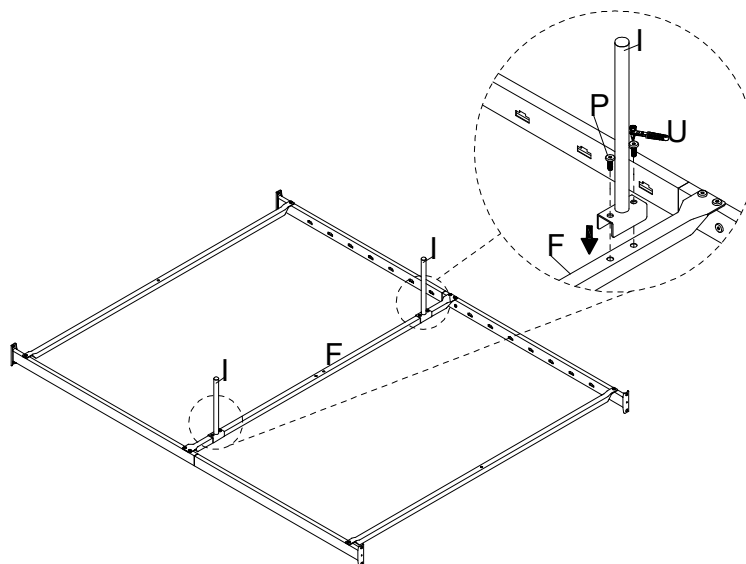
**6**

Attach the Left Leg (M), Right Leg (N), and Footboard (C) to Side Rails (D & E), insert the Bolt (Q), turn the Ratchet Tool (U) to tighten them.

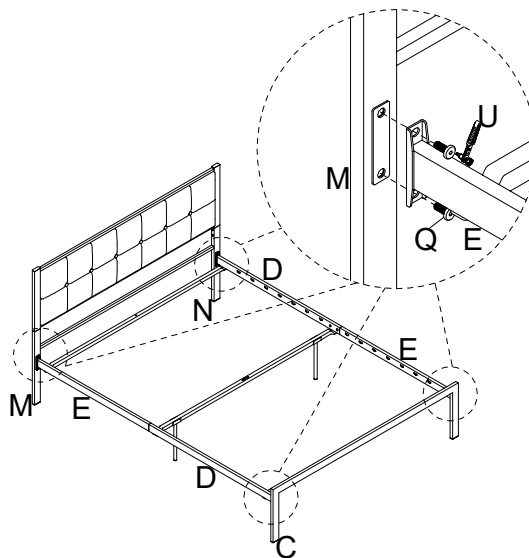

7

Attach the Center Rail (H) to Center Cross Bar (F) and Side Cross Bar (G), insert the Bolt (S) and Nut (T), turn the Ratchet Tool (U) and Wrench (V) to tighten them.

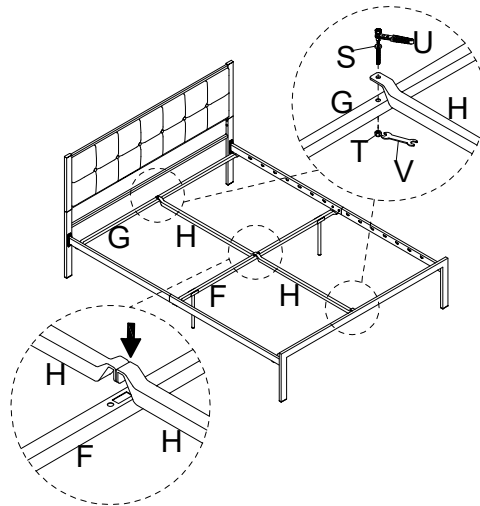
**8**

Attach the Support Leg (J) to Center Rail (H), insert the Bolt (P), turn the Ratchet Tool (U) to tighten them. Attach the Center Support Leg (I) and Bracket (O) to Center Cross Bar (F), insert the Bolt (S) and Nut (T), turn the Ratchet Tool (U) and Wrench (V) to tighten them.

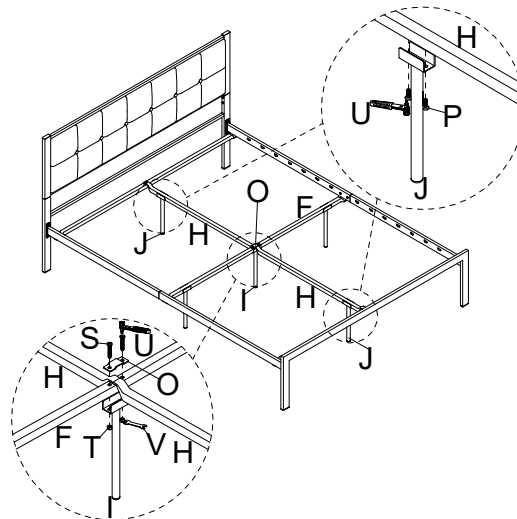
**9**

Insert Slat (K) into Side Rails (D & E) as illustrated, then lock Slat Connector (L) to fix Slat (K).

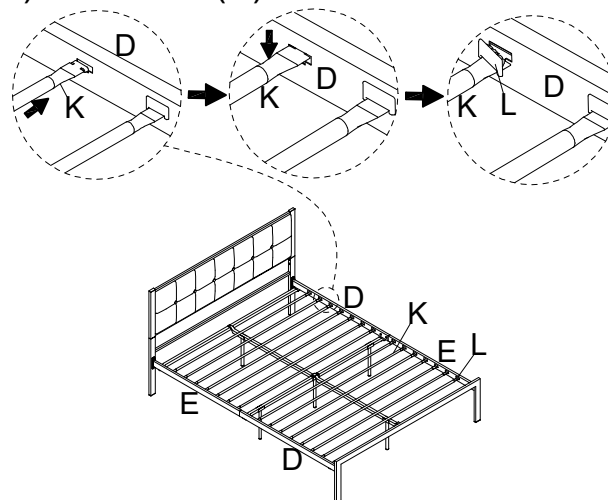

Cleaning & Care

Treat surfaces with care. Surfaces are resistant to scratches but are not scratch resistant. Clean surfaces with a dry or damp soft cloth. Do not use abrasive cleaners. Hardware may loosen over time. Periodically check that all connections are tight.