

Metal Bunk Bed

Full Over Full

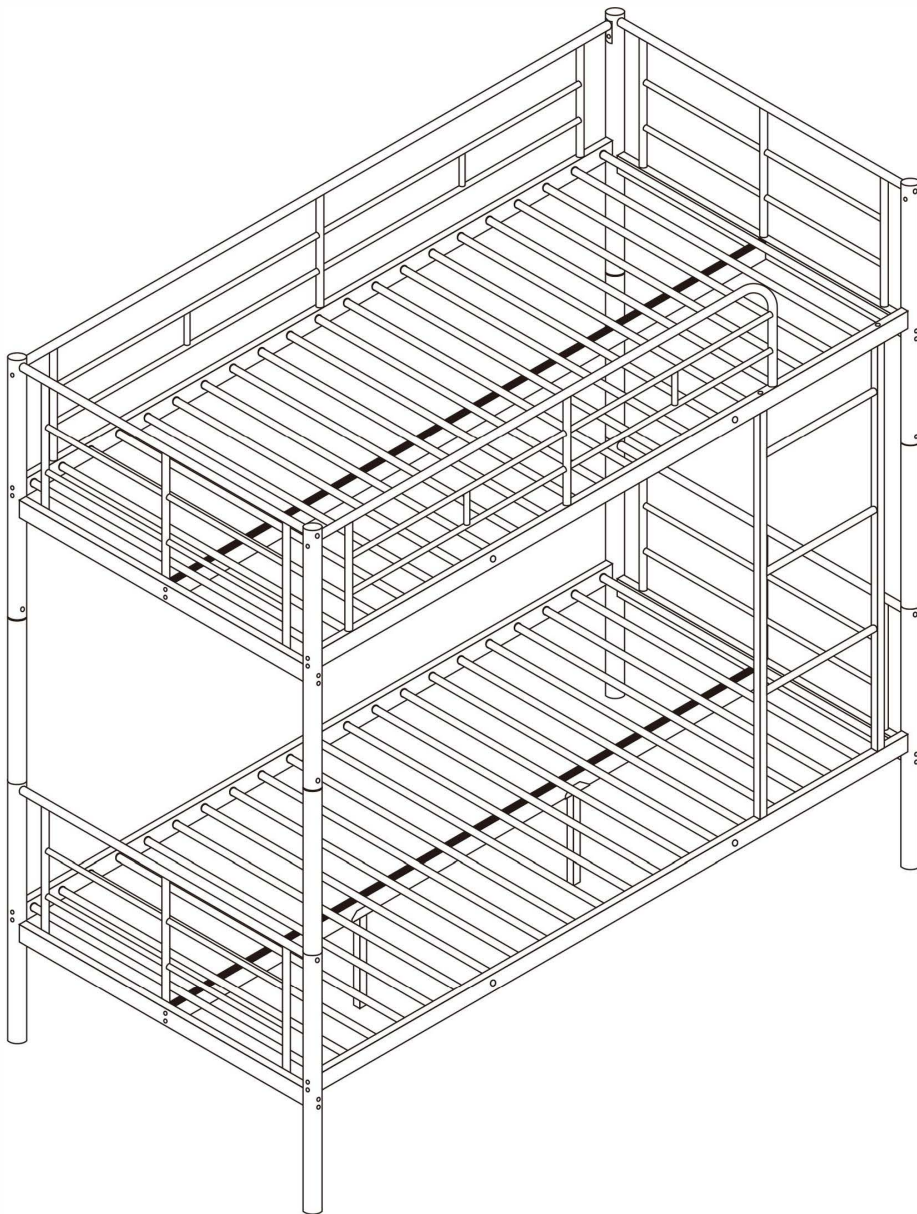

IMPORTANT-PLEASE READ CAREFULLY

1. Check the packaging and product to ensure there is no damage and all parts are complete.
2. Reading the installation manual can help you complete the assembly quickly.
3. Each accessory bag is numbered. Do not open them all at once to avoid confusion.
4. Ensure the installation location has a flat surface with no obstacles.
5. Assemble the parts on a scratch-free surface (e.g., the shipping box) to avoid scratches.
6. Regularly check the stability of the metal bunk bed to ensure it is secure during use.

SAFETY INFORMATION





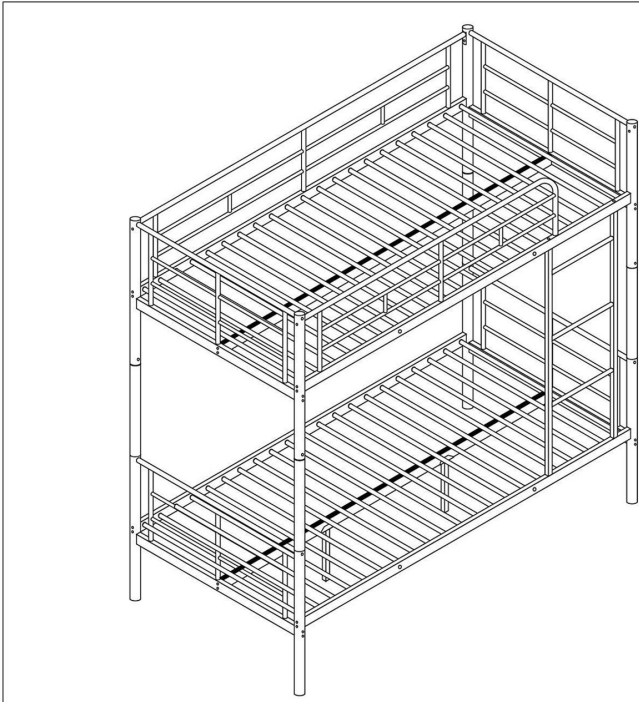

1. Always prohibit jumping on the bed.
2. Prohibit more than one person on upper bunk.
3. Always use the ladder for entering and leaving the upper bunk.

NEED HELP?

If you have any questions during the installation or setup process, please contact us. CustomerSupport@Zinus.com

PARTS DETAILS



A		M6x55	48
B		M6x32	3
C			3
D		M6x40	8
E		M6x15	16
F		M4	2
M			2

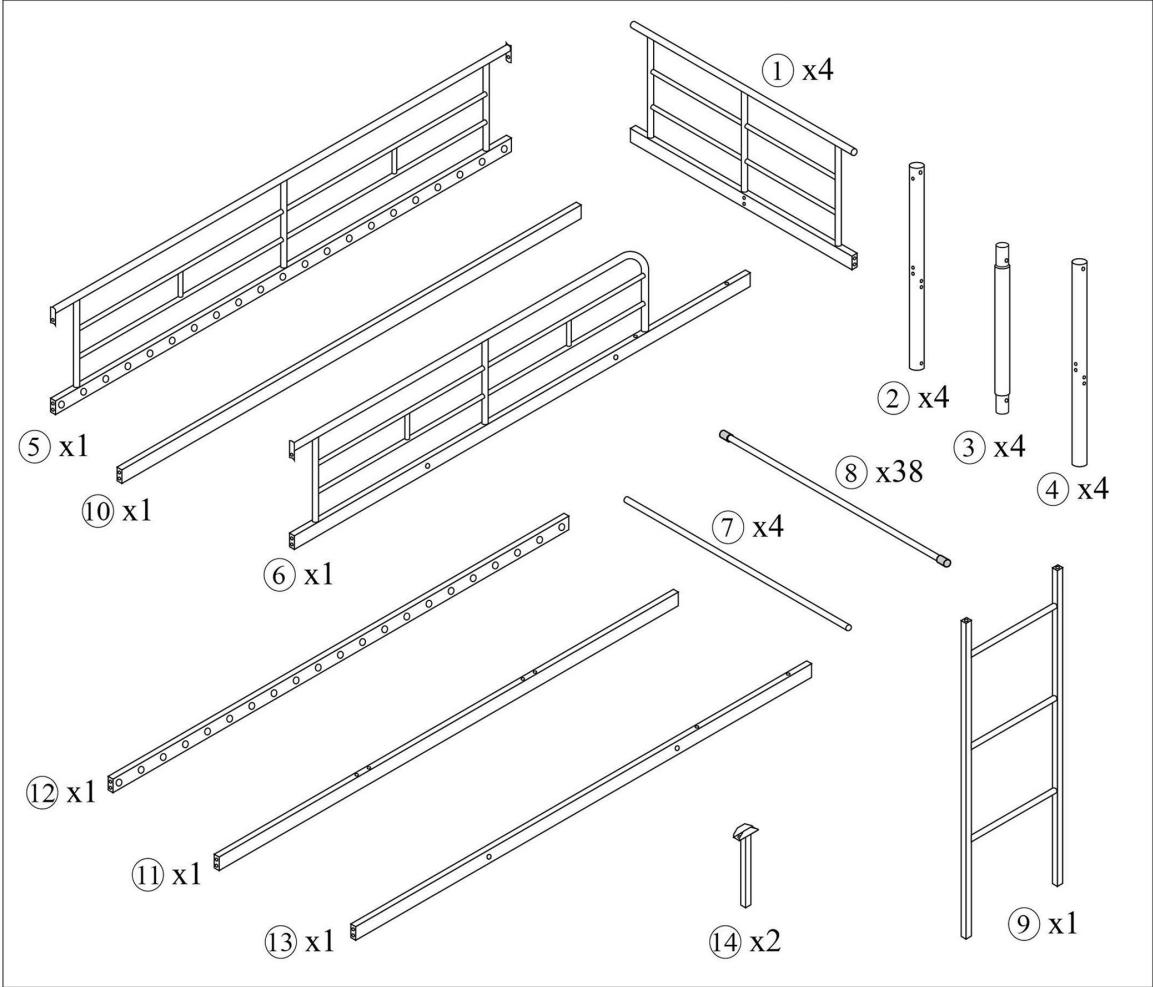

ASSEMBLY

