

NOTICE

*Please make sure that you have all parts indicated and they are in good condition before you begin assembly of this item. Refer to part list and hardware list below for guidance.

*This item should be assembled on a soft surface to prevent scratching the finish during assembly.

*This item may require periodic tightening.

*If you are having difficulty, our friendly Customer Care team is always here to help. Please email customersupport@safavieh.com

PREPARATION

*Before beginning assembly of product, make sure all parts are present. Compare parts with part contents list and hardware contents list.

*If any part is missing or damaged, do not attempt to assemble the product.

*Estimated Assembly Time: 20 minutes.

*Tools Required for Assembly (included): Allen Key

CARE AND MAINTENANCE

INDOOR METAL/ALUMINUM FURNITURE

Wipe spills immediately. Maintain with regular dusting and clean with mild soap and water, dry thoroughly and do not use a brass cleaner. Adhesive felt pads should always be used/applied in order to prevent damage to the furniture or surfaces on which the furniture is placed.

WOOD CARE

Adhesive felt pads should always be applied to areas of furniture which make direct contact with flooring, said application will prevent damage to the furniture and or surfaces on which the furniture lies. Objects placed on articles of furniture should rest on non abrasive material as to prevent damage to the wood finish. Objects whose composition consists of plastic and rubber are known to discolor and damage the wood surfaces on which they rest. Wipe up spills immediately and avoid common hazards such as hot dishes, harsh solvents and abrasives. Cleaning should be done with a soft lint free cotton cloth dampened with water or furniture polish. On highly used surfaces we recommend applying a quality paste wax which should be used on a regular basis to provide additional protection from scratches and spills. How often you apply the wax depends on how much wear the furniture receives.



Item ID# ETG4201

Product Dimensions:47-1/4"WX13"D X70-4/5"H

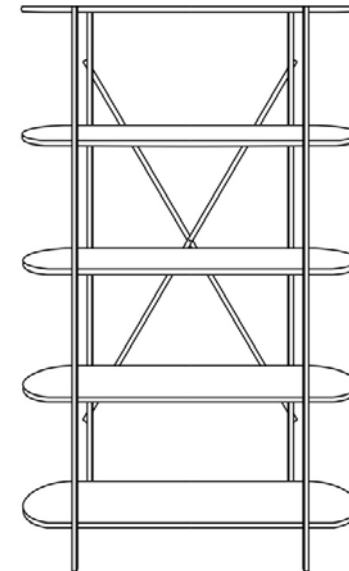







 **WARNING** 

Weight Capacity:60LBS

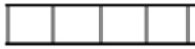
Warning:Do not stand on shelf

Warning:Do not over torque screws

Part List and Hardware List

PIECE	DESCRIPTION	PICTURE	QUANTITY
A	Shelf		5X
B	Metal Frame		2X
C	Metal plate		2X
HW1	Socket Screw M6x0.5x20mm		20X
HW2	Socket Screw M6x0.5x15mm		5X
HW3	Hex M6		1X
HW4	Allen key		1X
HW5	Wrench		1X

PREPARATION

*Before beginning assembly of product, make sure all parts are present. Compare parts with package contents list and hardware contents list.

*If any part is missing or damaged, do not attempt to assemble the product.

*Estimated Assembly Time: 20 minutes.

*Tools Required for Assembly (included): Allen Key

*If you are having difficulty, our friendly Customer Care team is always here to help. Please email customersupport@safavieh.com

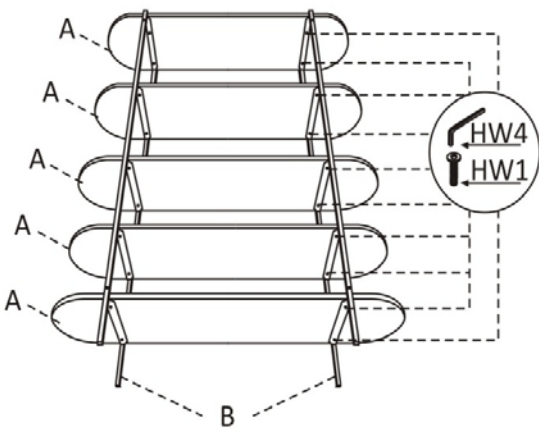
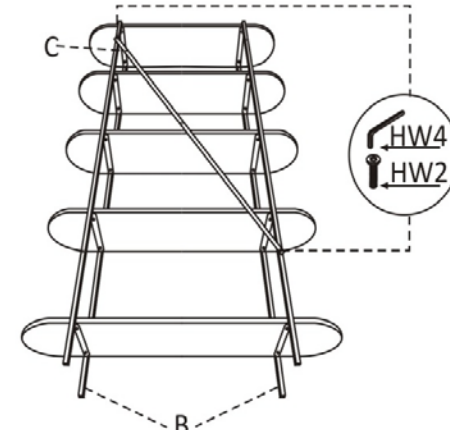
	
<p>STEP1: Attach the Shelf(A) to the Metal frame (B), using Socket Screw(HW1), Tighten with Allen key(HW4)</p>	<p>STEP2: Attach the Metal plate(C) to the Metal frame (B), using Socket Screw(HW2), Tighten with Allen key(HW4)</p>

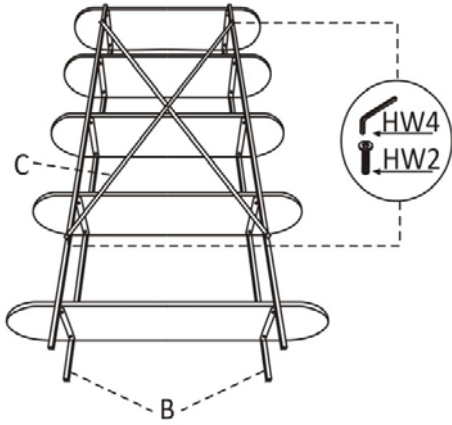

STEP3:Attach the Metal plate(C) to the Metal frame (B), using Socket Screw(HW2),Tighten with Allen key(HW4)

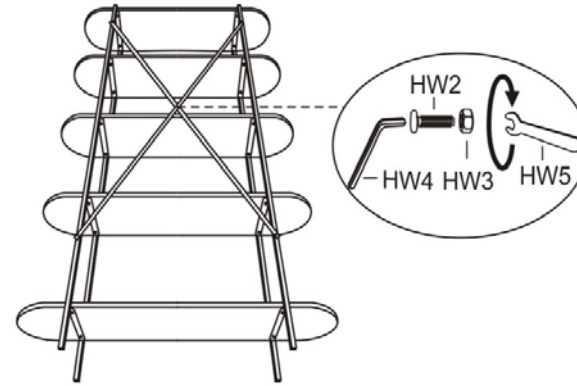

STEP4:Using Socket Screw(HW2) and Hex(HW3) to tighten the Metal plates (C) with Allen key (HW4) and Wrench (HW5)

Anti-Tip Kit



WARNING

Serious or fatal crushing injuries can occur from furniture tip over. To prevent tipover:

Install tipover restraint provided.

Place heaviest items in the lower drawers.

Unless specifically designed to accommodate, do not set TVs or other heavy objects on top of this product.





Never allow children to climb or hang on drawers, doors or shelves.

Never open more than one drawer at a time.

Do not defeat or remove the drawer interlock system.

Use of tipover restraints may only reduce, but not eliminate, the risk of tip over.

Part List and Hardware List

PIECE	DESCRIPTION	PICTURE	QUANTITY
HW4	Nylon Strap		2 PCS
HW5	Long Screw M4*25mm	 M4*25mm	2 PCS
HW6	Plastic Screw Anchor		2 PCS
HW7	Wall Bracket		2 PCS

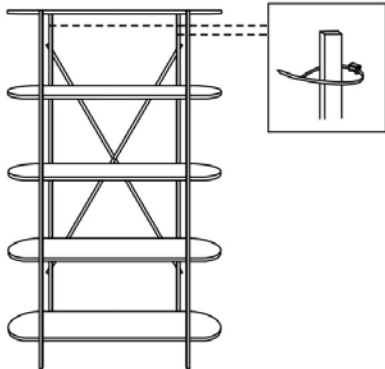

**SAFAVIEH**
FURNITURE

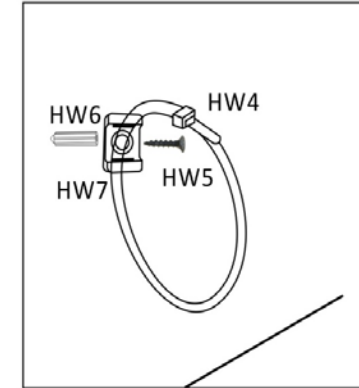

Assembly Steps

1. Mark the location on the wall for mounting the second bracket "HW7". Drill a 1/4 inch hole in the wall and insert the plastic screw anchor "HW6". Secure the bracket to the wall using the long screw "HW5".
2. Place the furniture so the bracket on the back edge of unit is lined with the bracket on the wall.
3. Lace the end of the nylon strap "HW4" down through each of the bracket. Bring both ends together and slide the beaded end of the strap through the keyhole shaped slot on the other end. Pull down on the beaded end until it snap-locks into the keyhole.
4. Check to make sure the strap is securely laced and locked to the brackets.
5. Complete!