

ASSEMBLY INSTRUCTION FOR SOFA

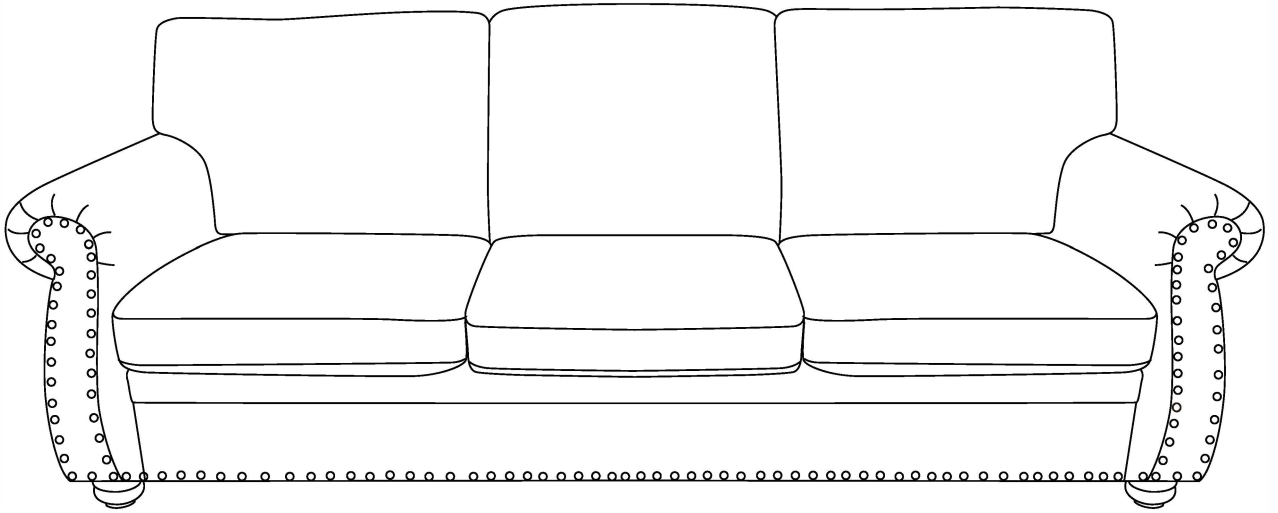

Components List

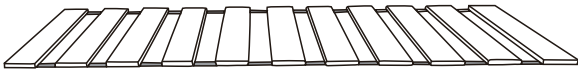

Gx1
Bed Slat

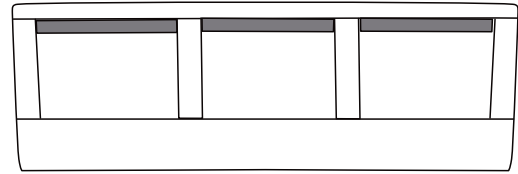

Hx1
Sofa Back

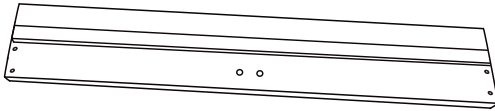

ix1
Back plate of the seat

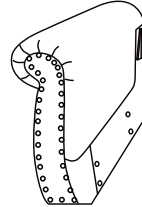

J-Lx1
Left arm

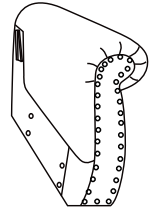

J-Rx1
Right arm

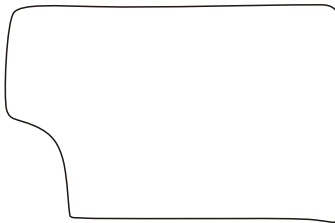

K-Lx1
Left back cushion

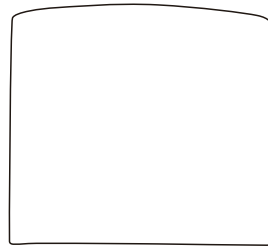

Kx1
Middle back cushion

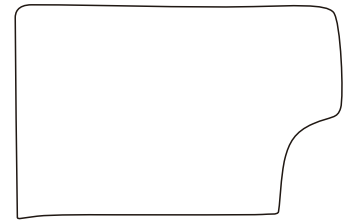

K-Rx1
Right back cushion

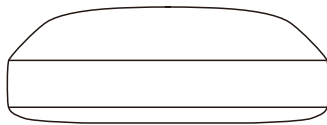

Lx3
Seat cushions

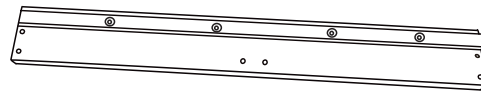

Mx1
Front plate of the seat



Nx1
Connecting rod of the seat

Hardware List

A M8x20mm



Bolt X20

B



Flat Washer X20

C



Washer X4

D



Allen key X1

D-1



Felt Pad X4

F

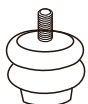

Leg X4

O



Metal connector X4

STEP 1:

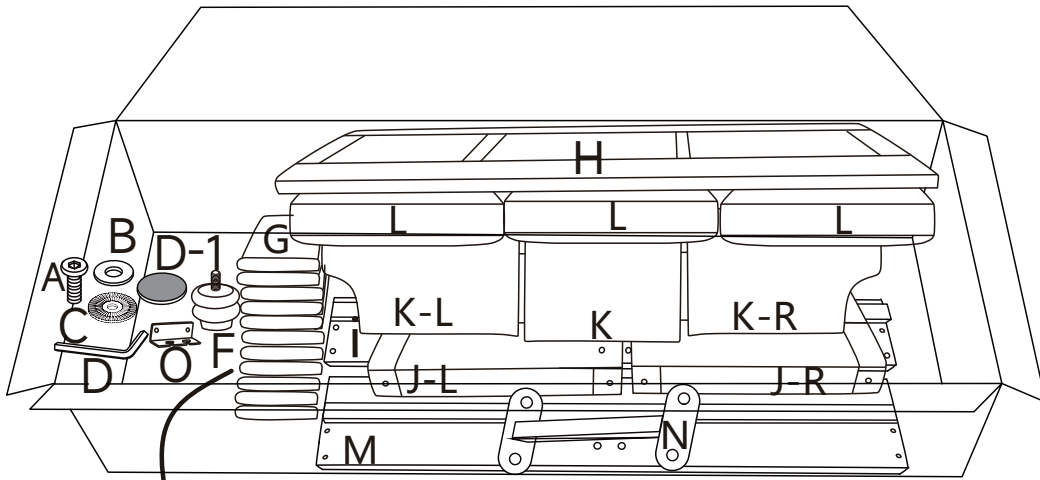



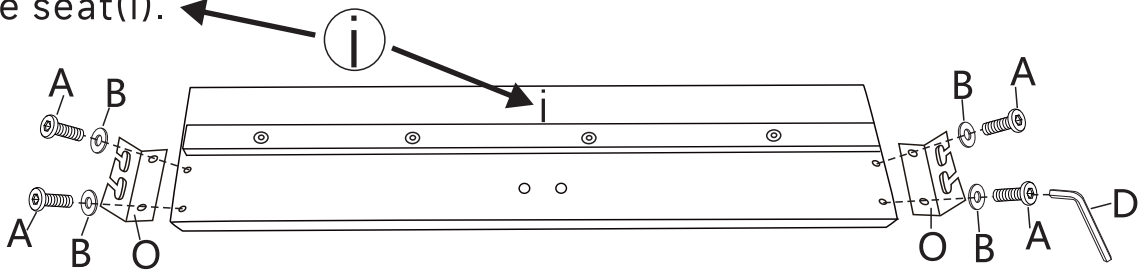

Taken. Back plate of the seat X1 , Front plate of the seat X1 ,
 Connecting rod of the seat X1 , Left arm X1, Right arm X1 ,
 Left back cushion X1 , Middle back cushion X1 , Right back cushion X1
 Seat cushions X3, Sofa Back X1 , Bed Slat X1 , Bolt X20 , Flat Washer X20
 Washer X4 , Allen key X1 , Felt Pad X4 , Leg X4 , Metal connector X4 .

STEP2: Use the Allen Key (D) to tighten the 2 pieces of Bolts (A) and 2 pieces of Flat Washer (B) to secure the metal connector (O) to the Back plate of the seat (i).

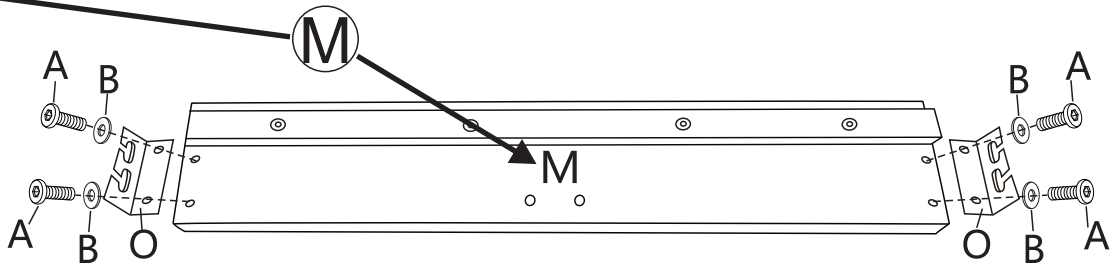





Use the Allen Key (D) to tighten the 2 pieces of Bolts (A) and 2 pieces of Flat Washer (B) to secure the metal connector (O) to the Front plate of the seat (M).

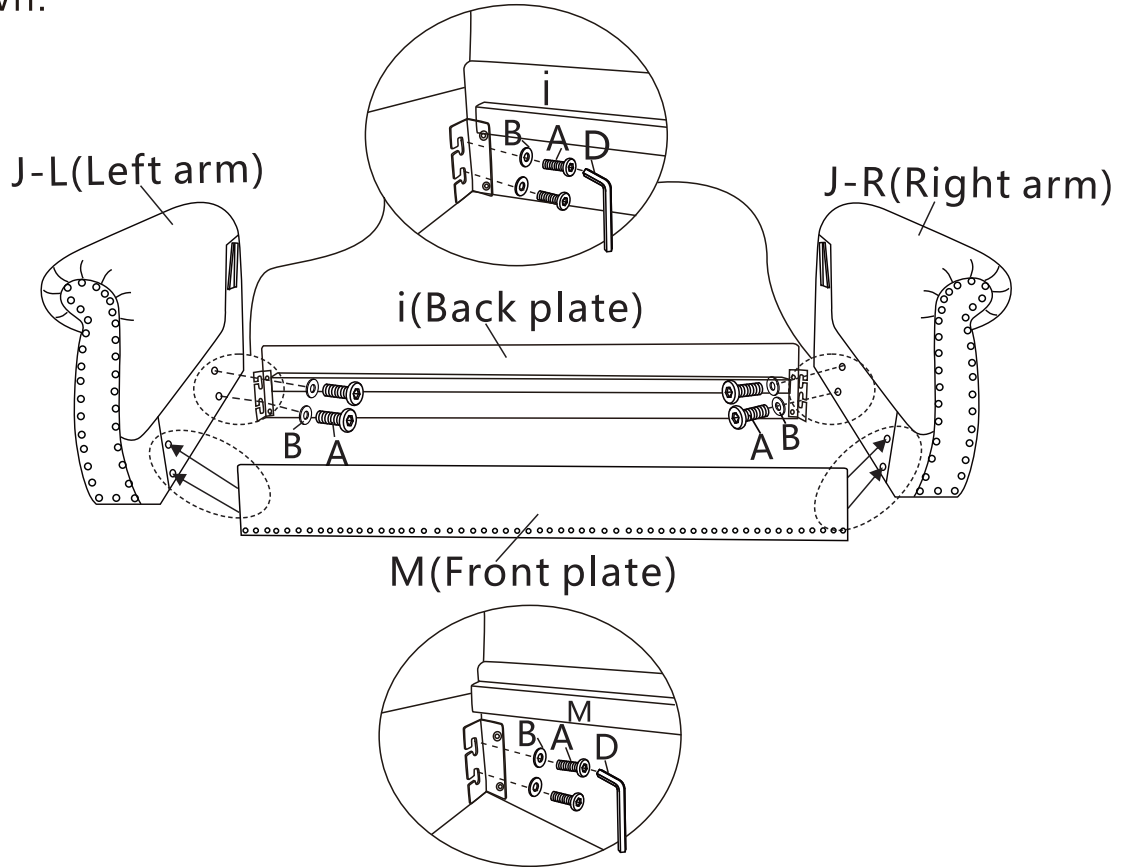

	Ax8
	Bx8
	Dx1





STEP 3: Use Allen key (D) to tighten the Metal connector (O) with 4 pieces of Bolt (A) and 4 pieces Flat Washer (B) to secure the Left arm (J-L) and Right arm (J-R) to the Back plate of the seat (i) and Front plate of the seat (M) as shown.

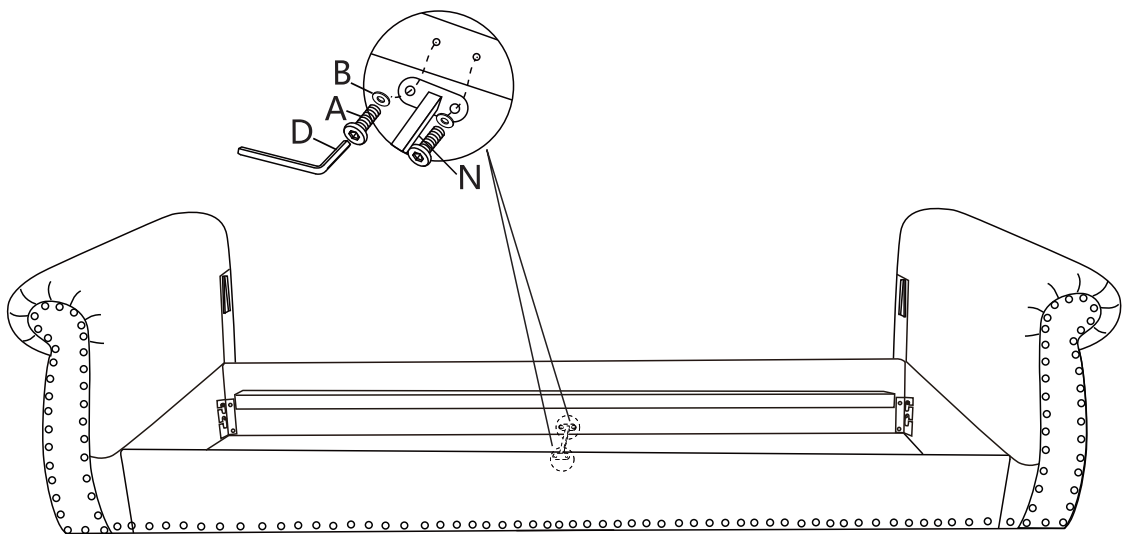

	Ax8
	Bx8
	Dx1

STEP 4 : Use Allen Key (D) to tighten Connecting rod of the seat (N) to the Back plate of the seat (i) and Front plate of the seat (M) with 4 pieces of Bolt (A) and 4 pieces Flat Washer (B).



	Ax4
	Bx4
	Dx1
	Nx1

STEP 5: Insert Sofa Back (H) to Left Arm (J-L) and Right Arm (J-R) by using the pre-installed Clips on Left Arm (J-L), Right Arm (J-R) and Sofa Back (H) to lock each other as shown.

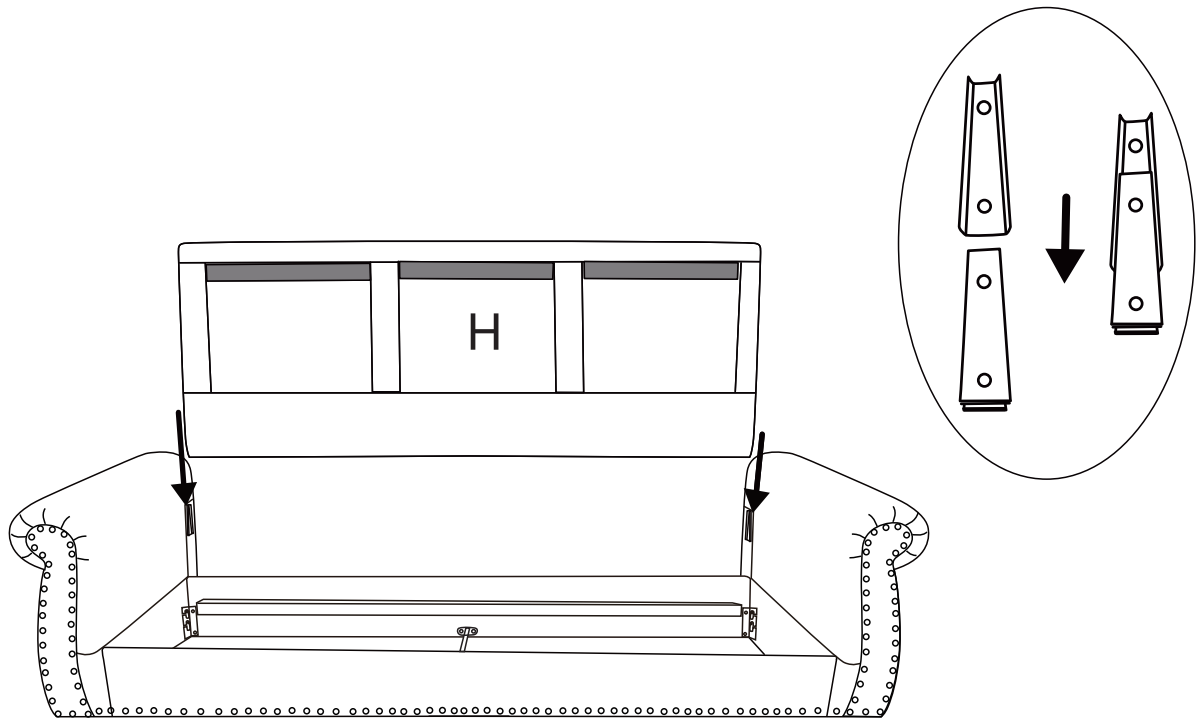

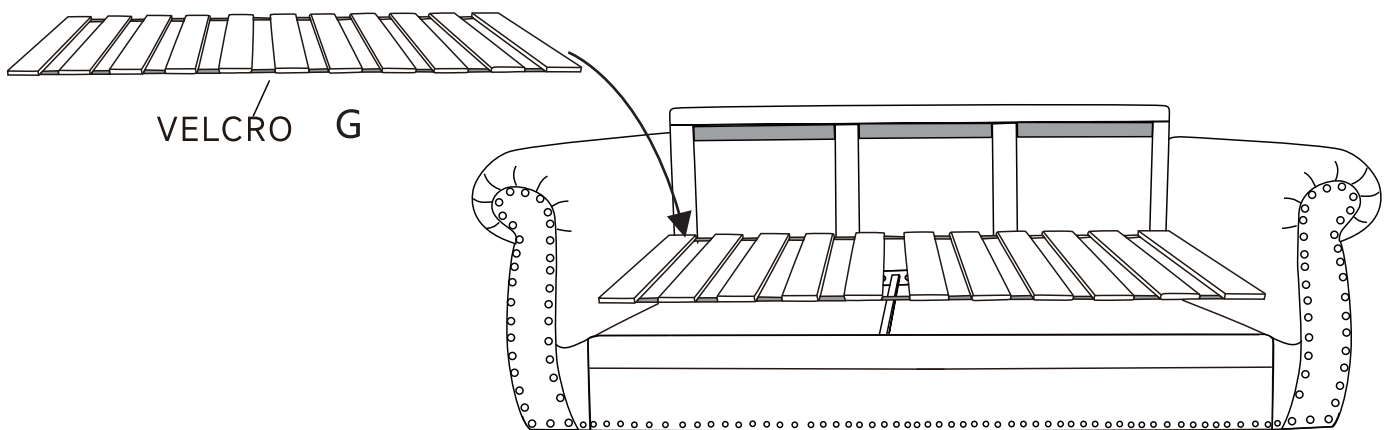

STEP 6: Carefully to open the Bed slat (G) and lay out them flat on the seat frame, then secure them with velcro on the seat frame.

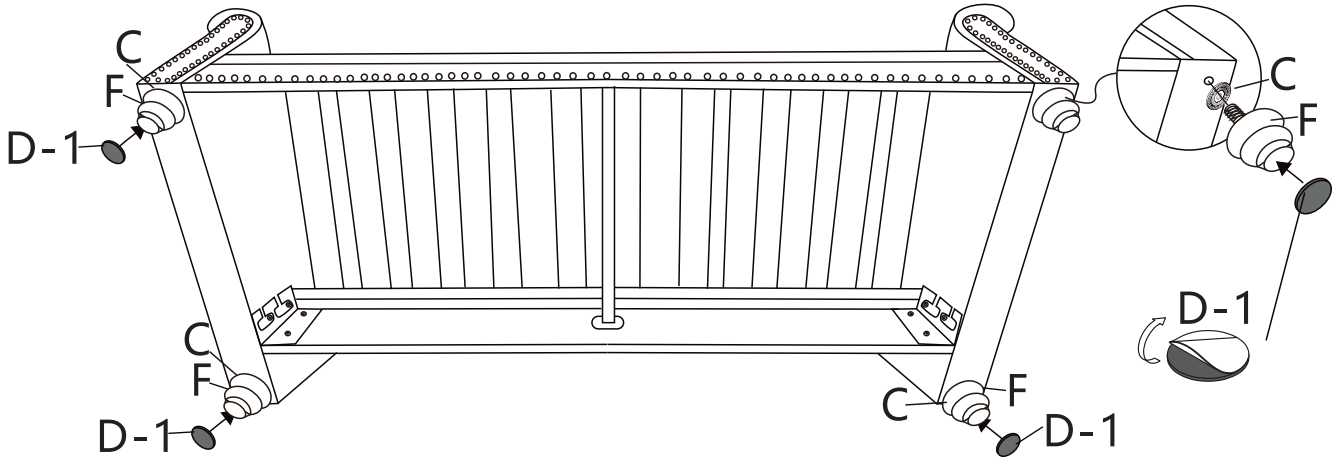

STEP 7 : Tighten 4 pieces of Washer (C) and Legs (F) to the bottom of the Sofa Seat clockwise as shown by hand. Then stick 4 pieces of the Felt Pads (D-1) to the bottom of the Legs (F).



	Fx4
	D-1x4
	Cx4

STEP 8: Carefully put 3 pieces of seat cushions (L) flat them on the Bed slat (G).

Take out all the parts in the box, wait 72 hours after opening the vacuum bag to fully regain fluffiness and pat the bag, the effect will be better if it is exposed to the sun.

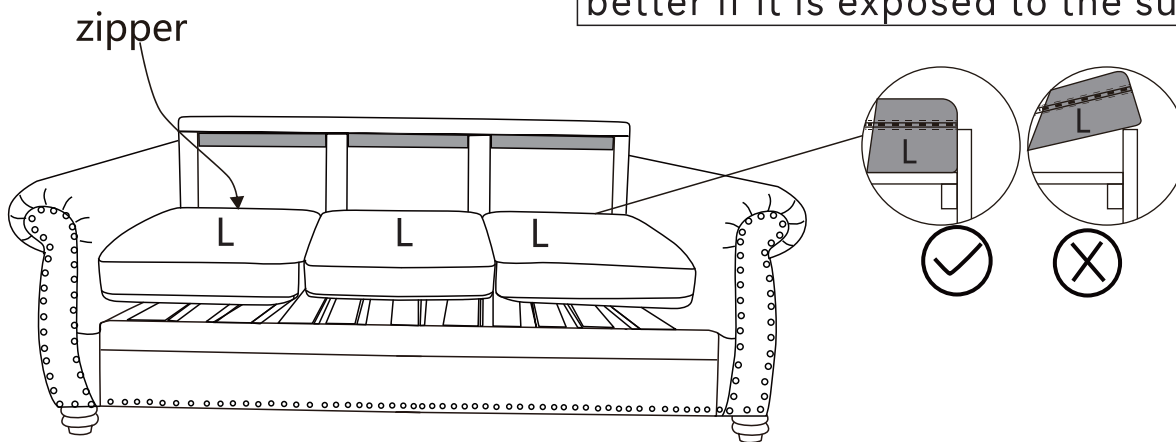

Pay attention Because of the packaging, if there is a crease on the cover, it is not the quality problem of the product. please iron it with an iron, it will not affect the use.

STEP 9 : Remove the protective strip of the Velcro on the Sofa back (H), then Carefully put 1 piece of Left back cushion (K-L), 1 piece of middle back cushion (K) and 1 piece of Right back cushion (K-R) to the assembled Sofa as shown

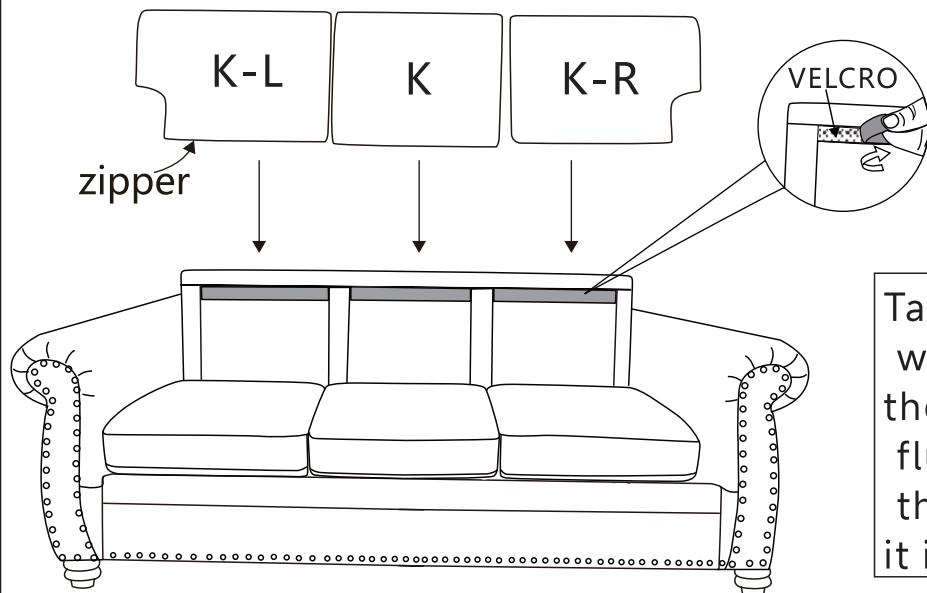

Take out all the parts in the box, wait 72 hours after opening the vacuum bag to fully regain fluffiness and pat the bag, the effect will be better if it is exposed to the sun.

STEP10: Remove the protective strip of the Velcro on the back of sofa, then tight the Velcro to the armrest.

