

# Instruction Manual

## Part List

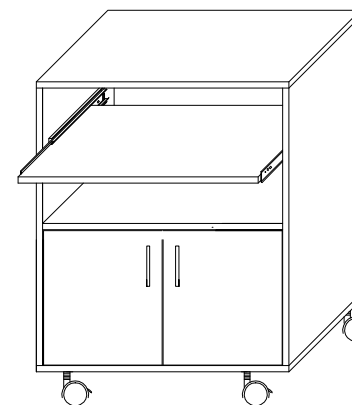

## Step 1

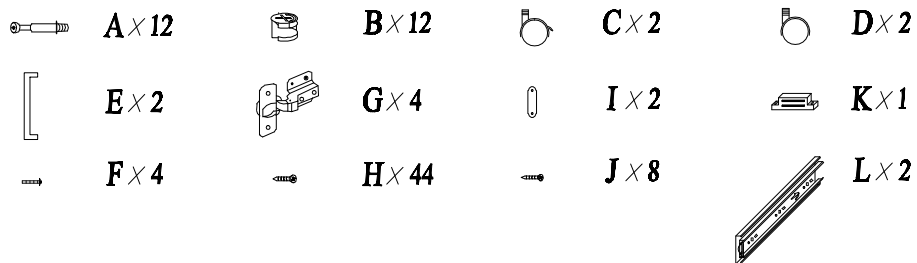
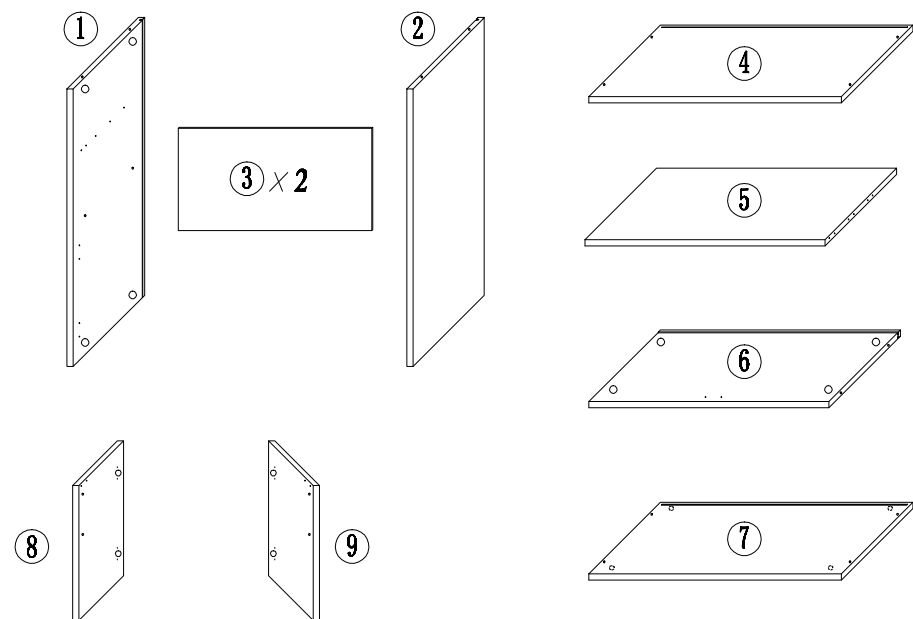
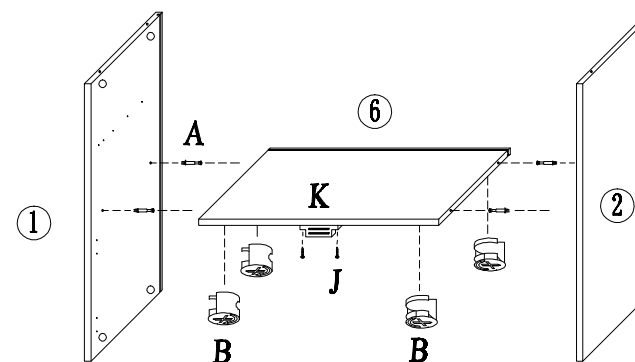

### Step2

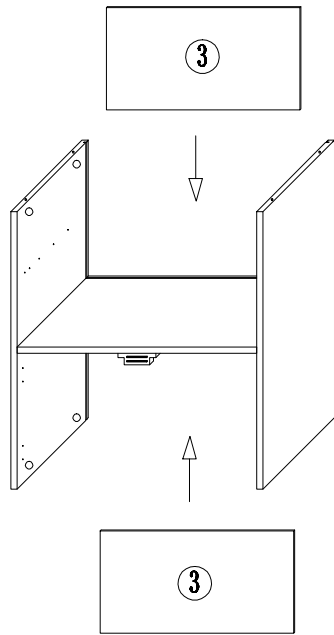

### Step3

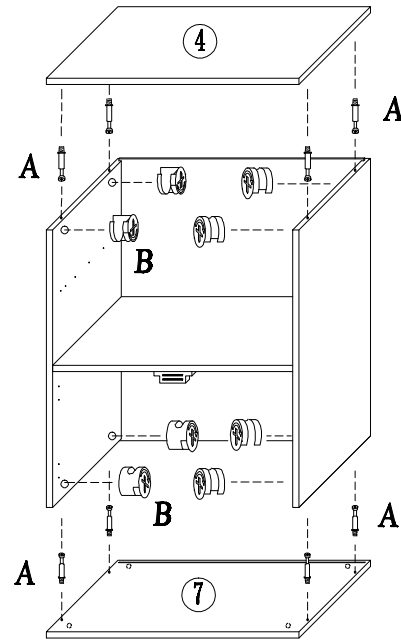

### Step4

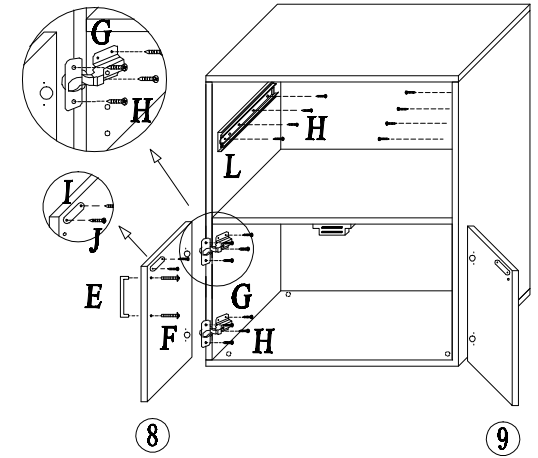

### Step5

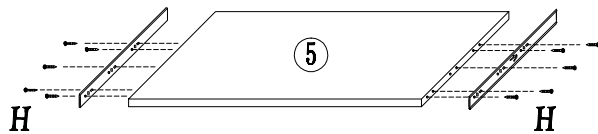

### Step6

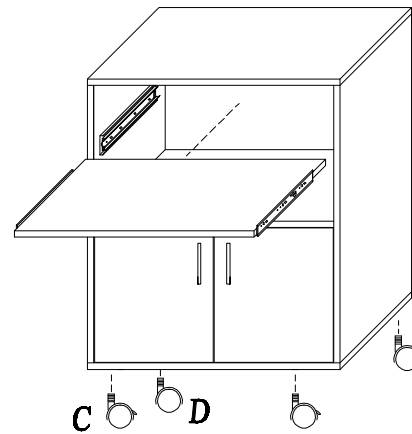

### Step7

