

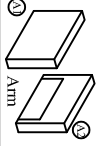

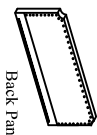







A		1 pc
B		1 pc
C		1 pc
D		1 pc
E		4 pcs
Packing Hardware		
1		1 pc
2		1 pc
3		26 pcs
4		4 pcs
5		4 pcs
6		4 pcs
7		4 pcs

Step 1 : Tighten the leg (E) to arm (A).



Step 2 : Attach the back panel (B) to arm (A). Attach side rail (D) to arm (A) by pushing the bracket down to fit it. Tighten with Allen Key (1).

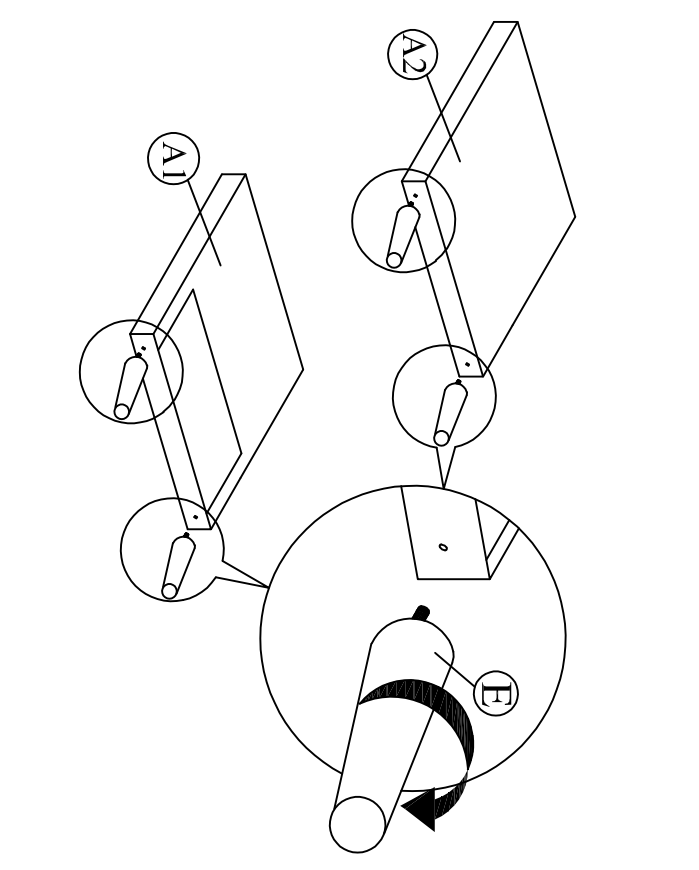
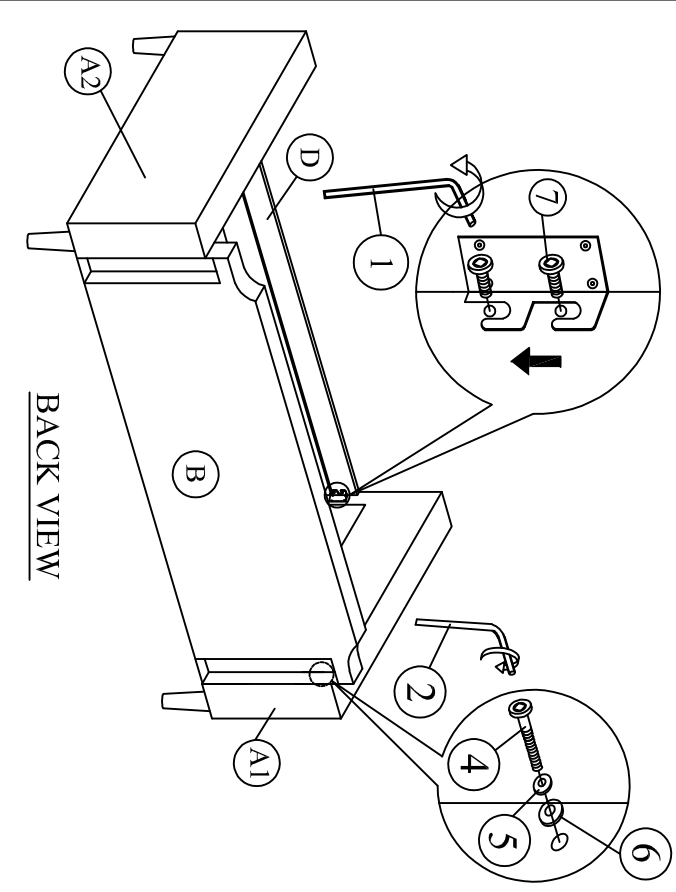

Step 3 : Tighten the slats with CSK screw (3). The distance of the slats should be sufficient to obtain desirable bed stability.

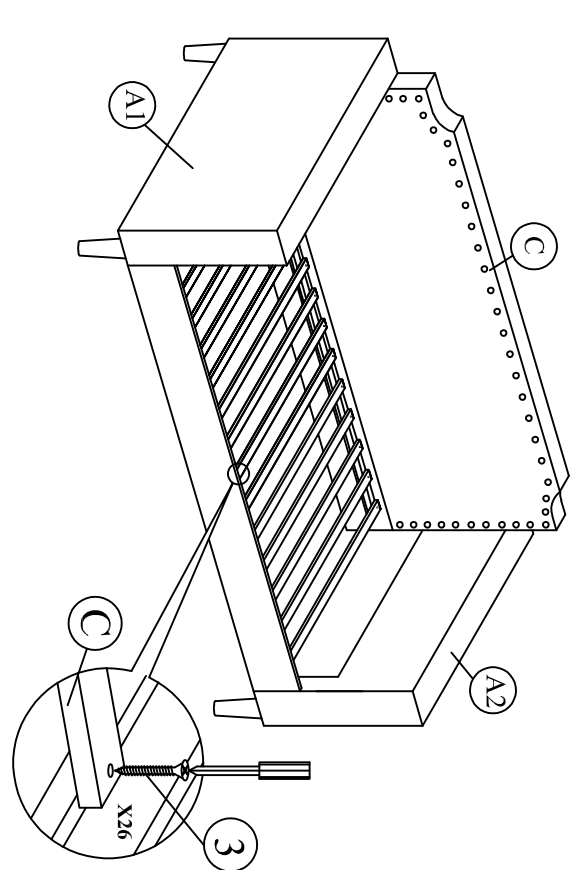

Step 4 : Assembly is complete.

