

PLATFORM BED FRAME CADRE DE LIT PLATEFORME

Assembly Instructions - Please keep for future reference

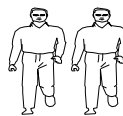
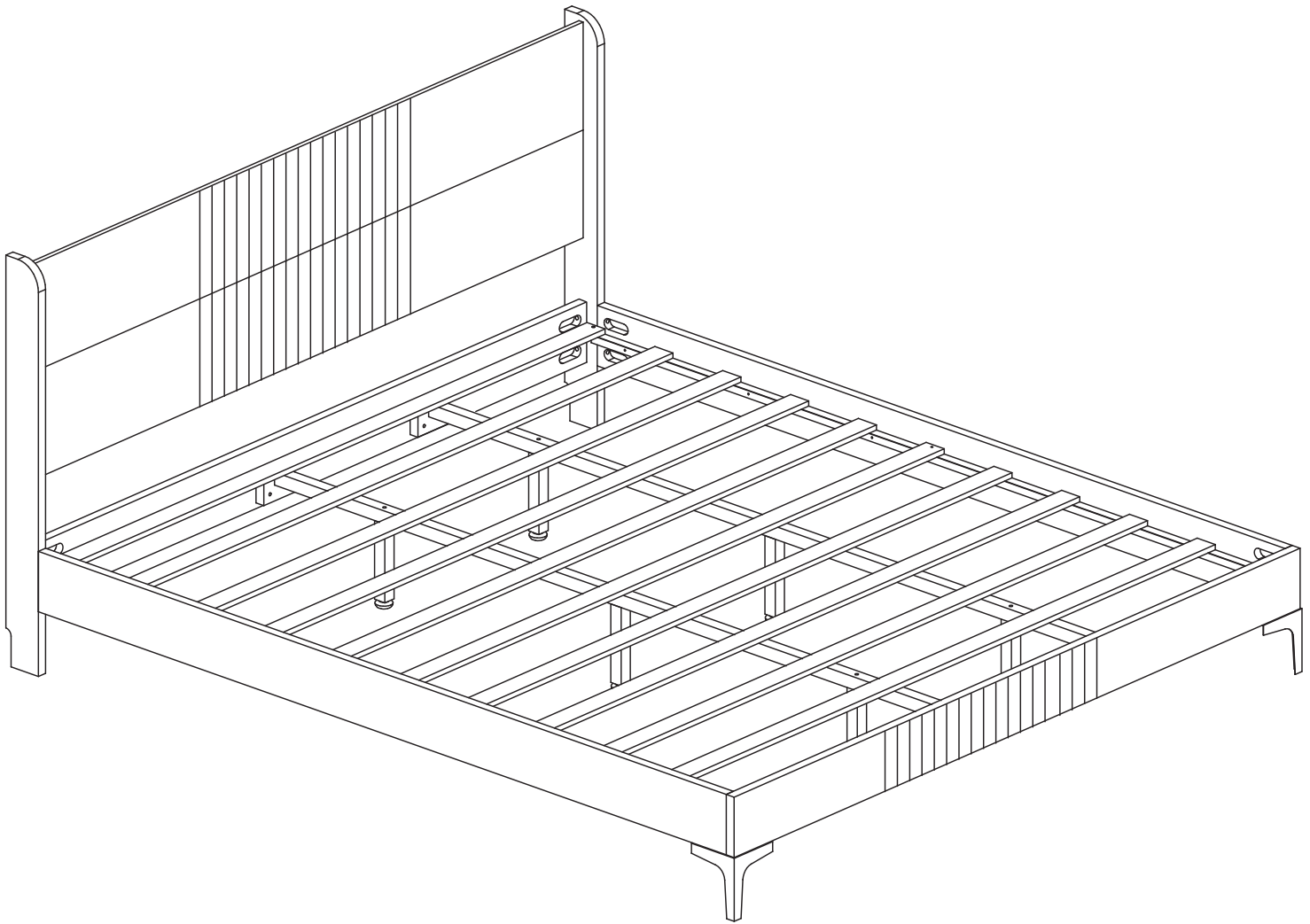

Two people are required to assemble and move this model.

Important – Please read these instructions fully before starting assembly

Safety and Care Advice

- Check you have all the components and tools listed on the following pages.

- Remove all fittings from the plastic bags and separate them

- Keep children and pets away from the installation area, which may cause choking if small parts are swallowed.

- Make sure you have enough space to layout the parts before

- Do not stand or apply weight to the product during assembly. This may cause damage.

- Assemble the item as close to its final position (in the same room) as possible.

- Assemble on a soft level surface to avoid damage to the unit or floor.

- It's easier for two people to assemble the parts together.

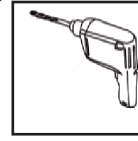

- To reduce the likelihood of damage to your product, make sure your power drill is set to a low torque setting.

Care and maintenance

- Only clean using a damp cloth and mild detergent, do not use bleach or abrasive cleaners.

- Check for loose screws on this unit from time to time.

- This product should not be discarded with household waste. Take to your local authority waste disposal centre.

Handy Hints





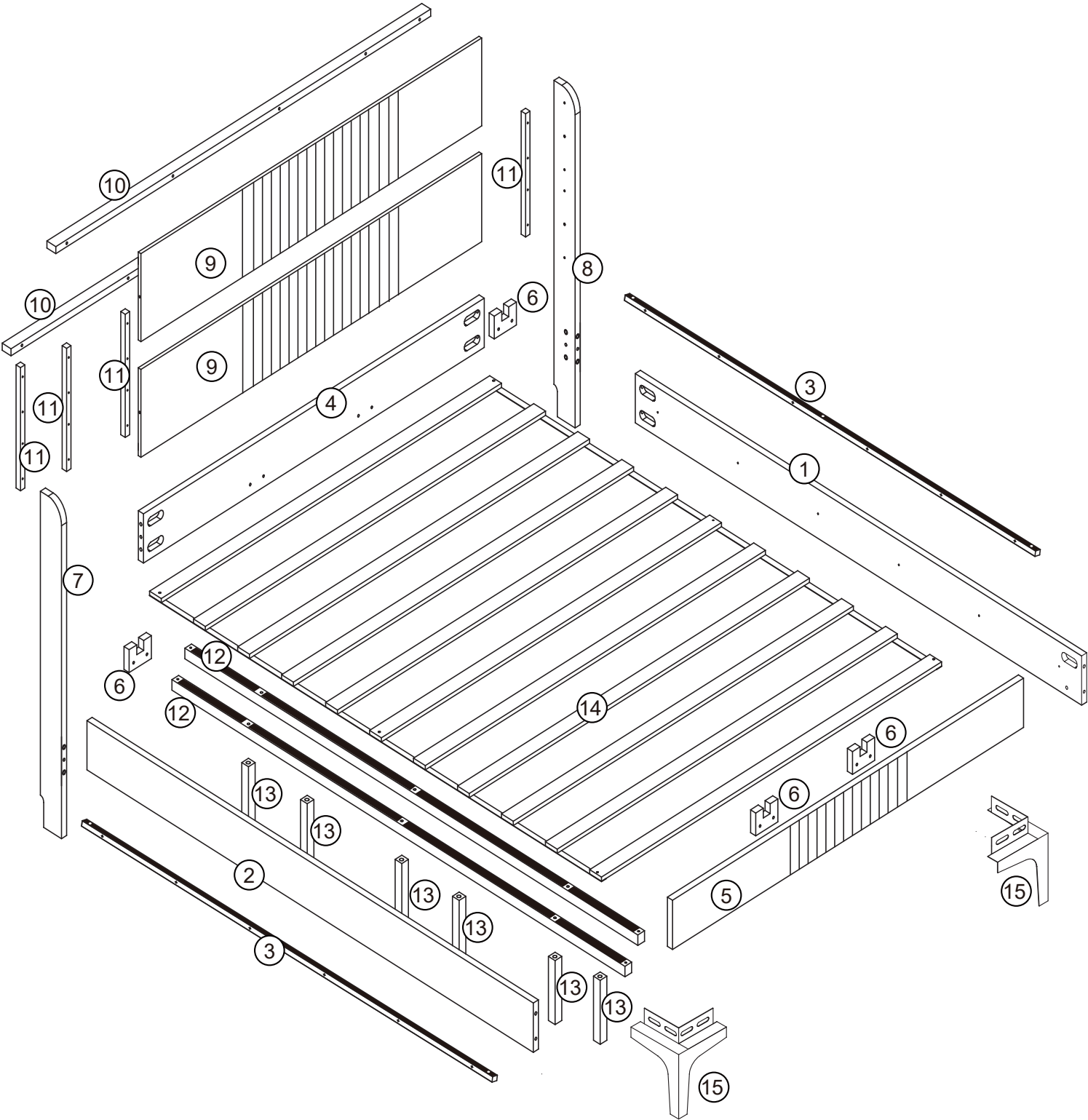

- Assemble all parts and bolts loosely during assembly, only once the product is complete should you fully tighten the bolts

- Regularly check and ensure that all bolts and fittings are correctly tightened.

Assembly Instructions

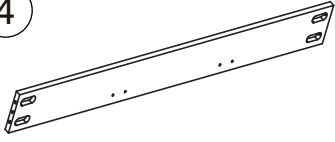
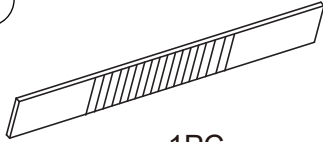
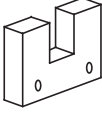
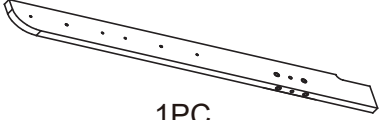
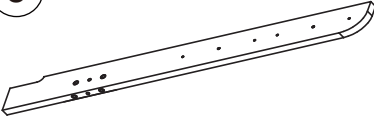
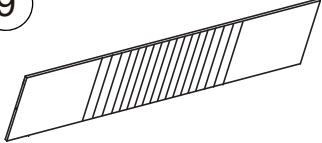



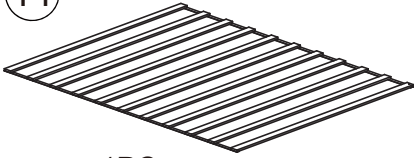
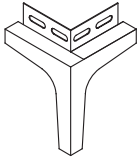







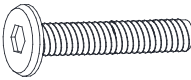

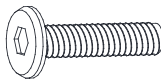
Part List

<p>①</p>  <p>1PC</p>	<p>②</p>  <p>1PC</p>	<p>③</p>  <p>2PCS</p>
<p>④</p>  <p>1PC</p>	<p>⑤</p>  <p>1PC</p>	<p>⑥</p>  <p>4PCS</p>
<p>⑦</p>  <p>1PC</p>	<p>⑧</p>  <p>1PC</p>	<p>⑨</p>  <p>2PCS</p>
<p>⑩</p>  <p>2PCS</p>	<p>⑪</p>  <p>4PCS</p>	<p>⑫</p>  <p>2PC</p>
<p>⑬</p>  <p>6PCS</p>	<p>⑭</p>  <p>1PC</p>	<p>⑮</p>  <p>2PCS</p>

Hardware list

Please check you have all the panels listed below

Note: The quantities below are the correct amount to complete the assembly. In some cases, more fittings may be supplied than required.

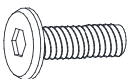
<p>A</p>  <p>(6*40mm) x 26</p>	<p>B</p>  <p>(8*40) x 6</p>	<p>C</p>  <p>x 14</p>
<p>D</p>  <p>(6*35mm) x 8</p>	<p>E</p>  <p>x 8</p>	<p>F</p>  <p>x 8</p>
<p>G</p>  <p>(5*25mm) x 22</p>	<p>H</p>  <p>(5*35mm) x 12</p>	<p>I</p>  <p>(5*50mm) x 4</p>
<p>J</p>  <p>x 6</p>	<p>L</p>  <p>(6*30) x 4</p>	<p>K</p>  <p>x 1</p>
<p>M</p>  <p>x 1</p>	<p>O</p>  <p>(6*15mm) x 4</p>	

Assembly Tools Required (Not Included)

Assembly Instructions

Step 1

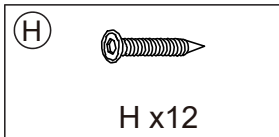
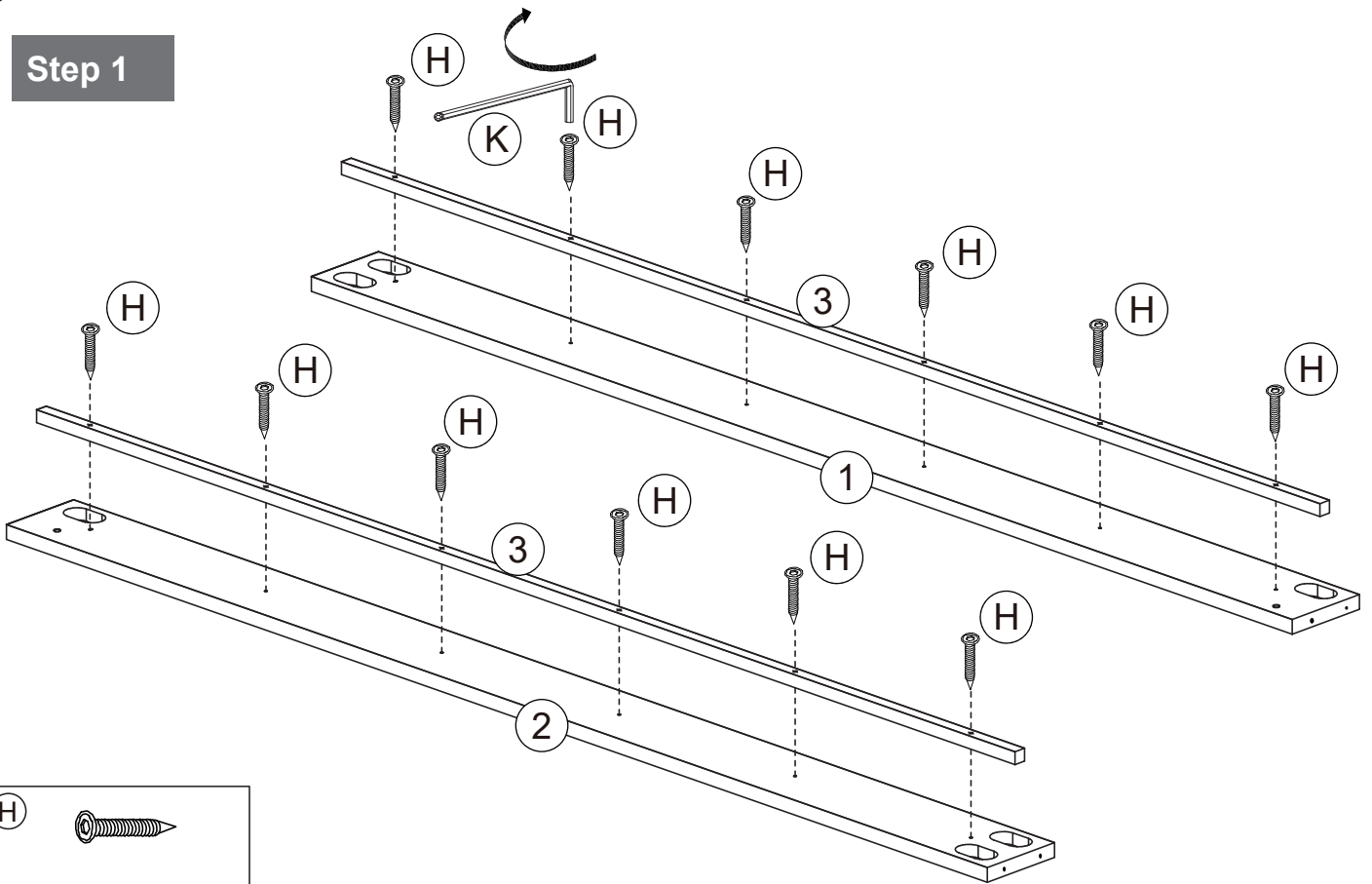

Step 2

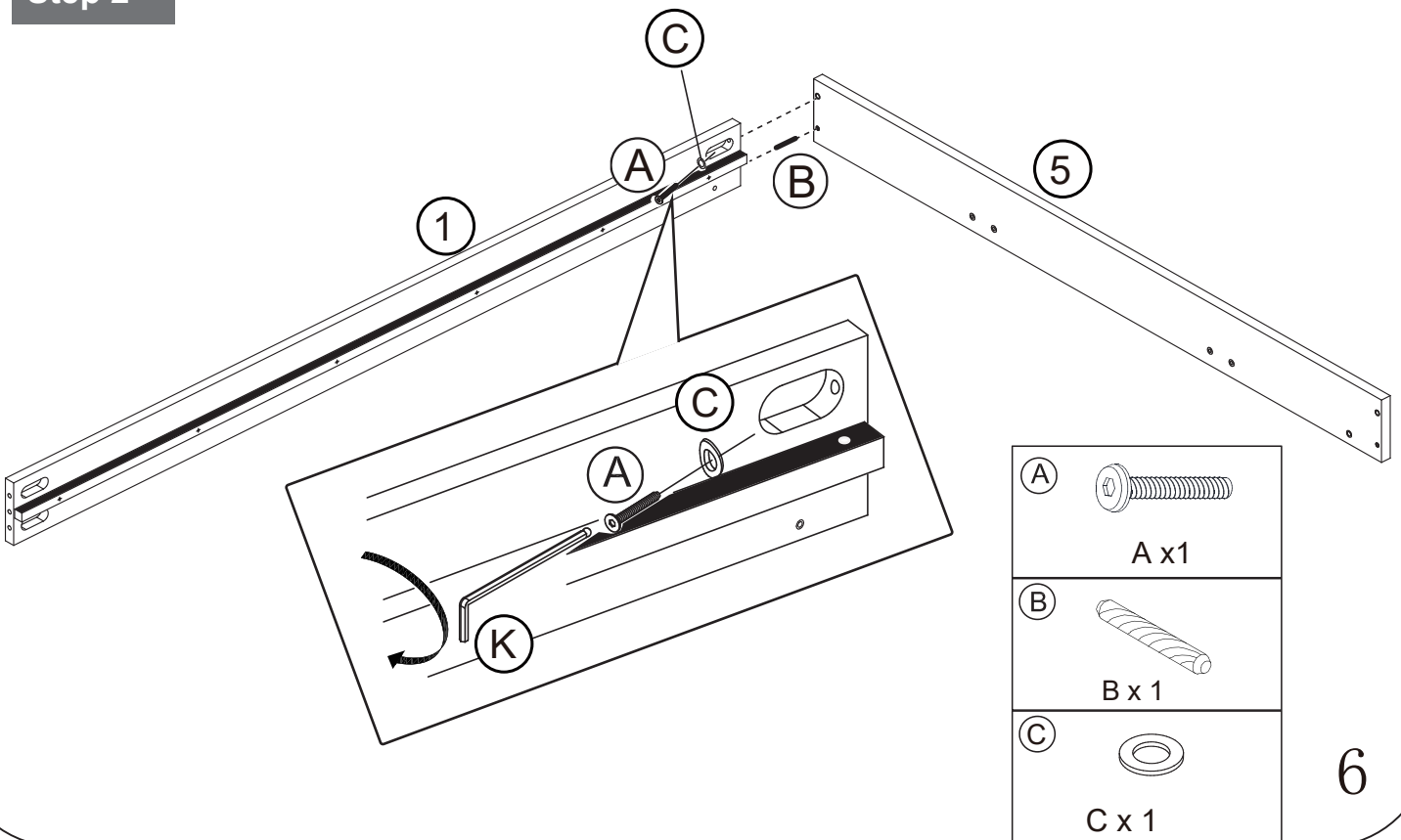

Assembly Instructions

Step 3

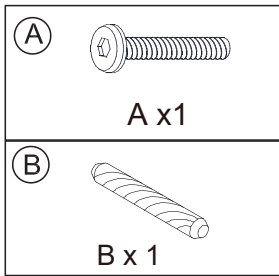
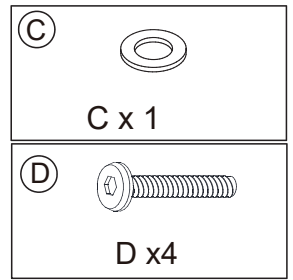
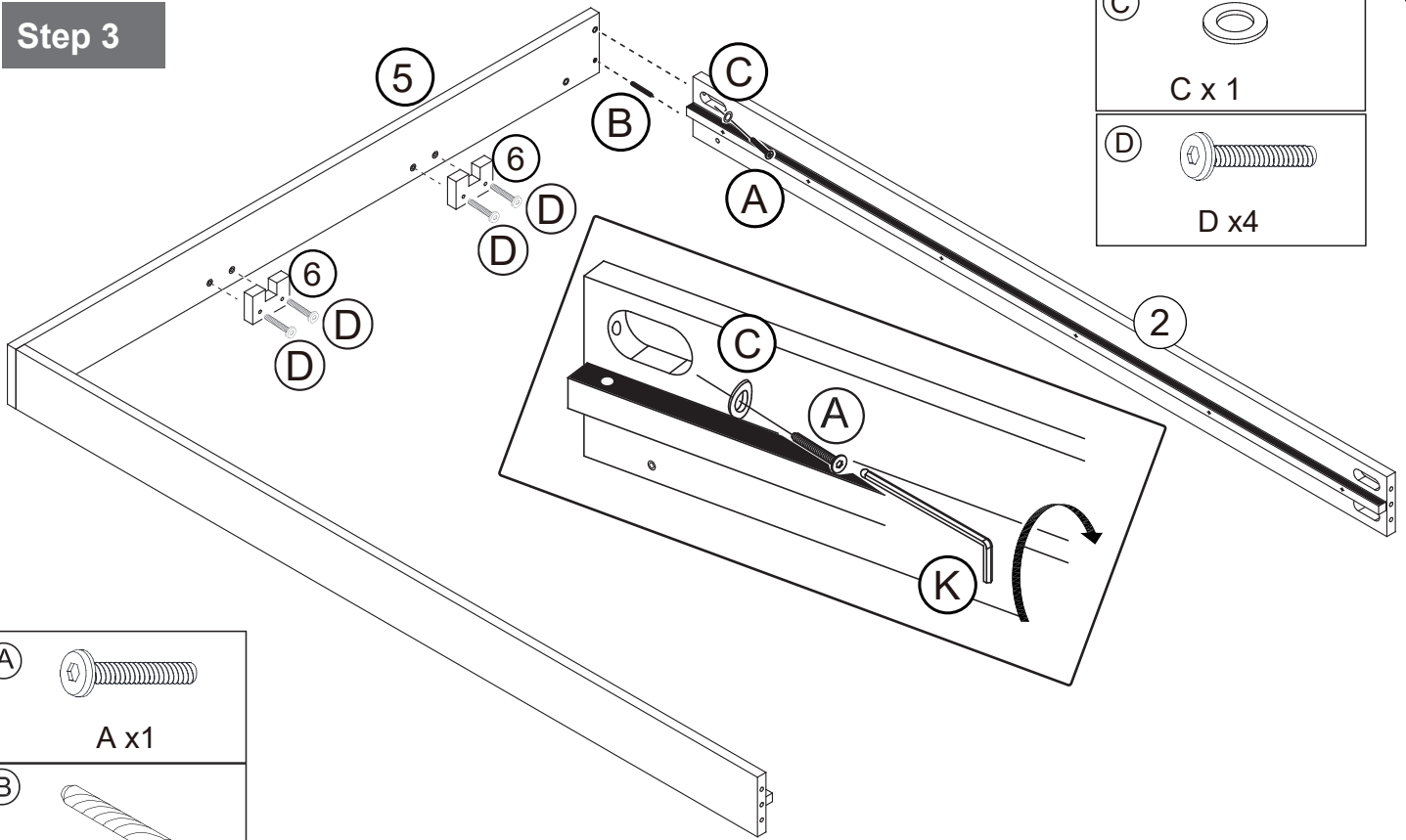

Step 4

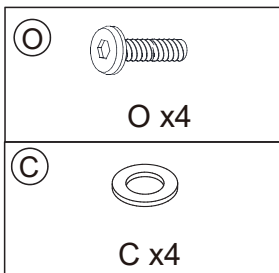
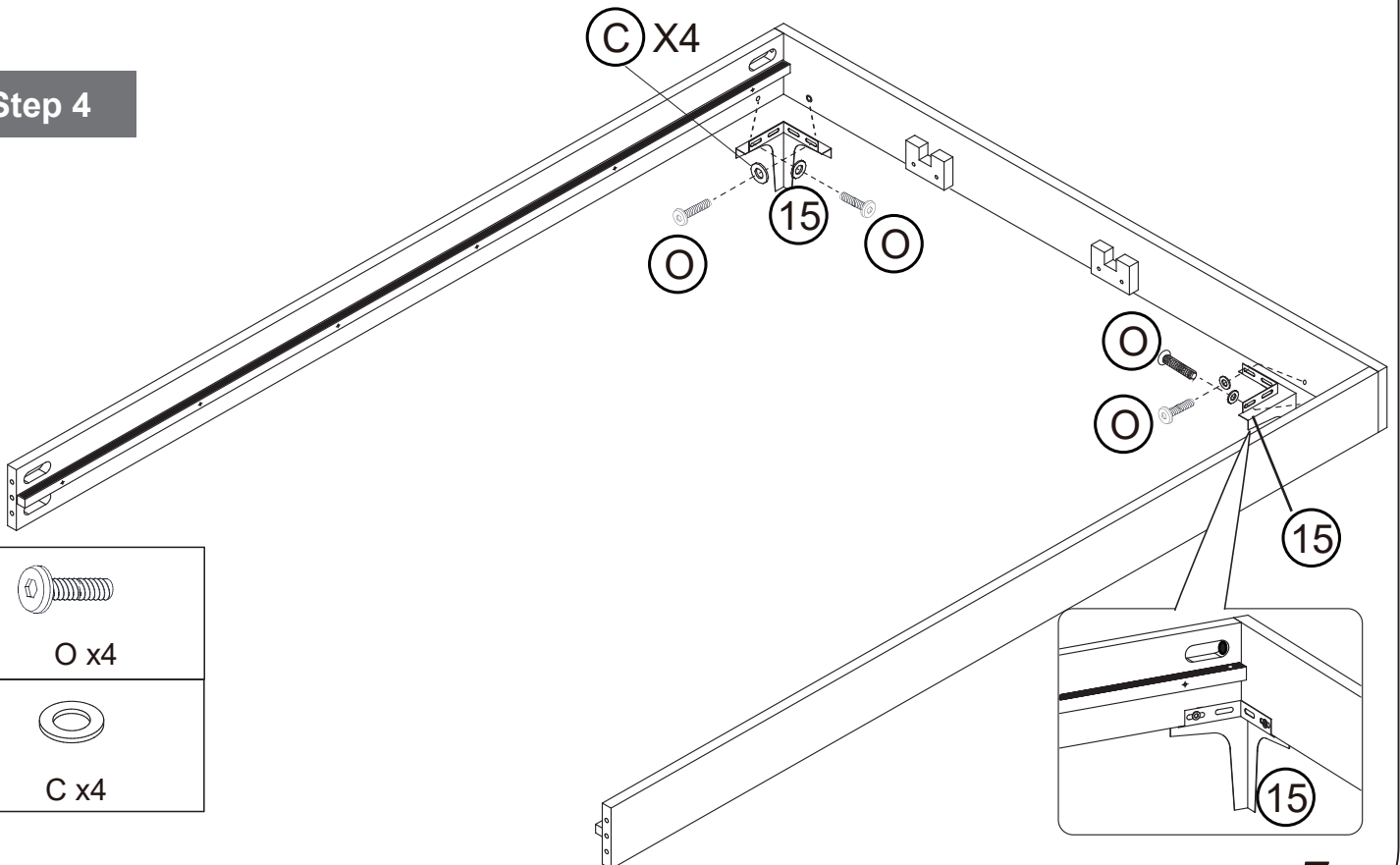

Assembly Instructions

Step 5

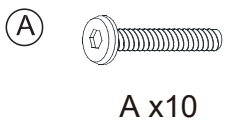
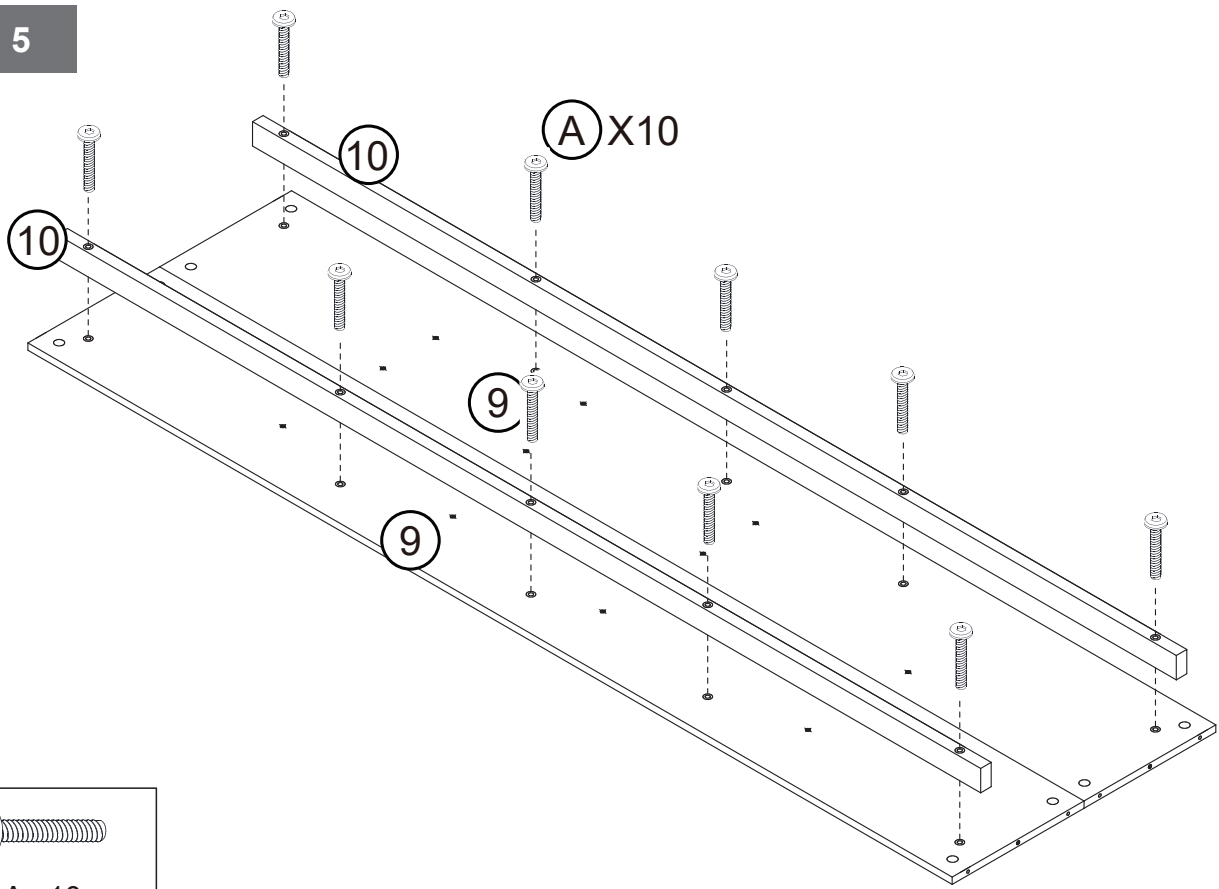

Step 6

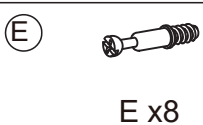
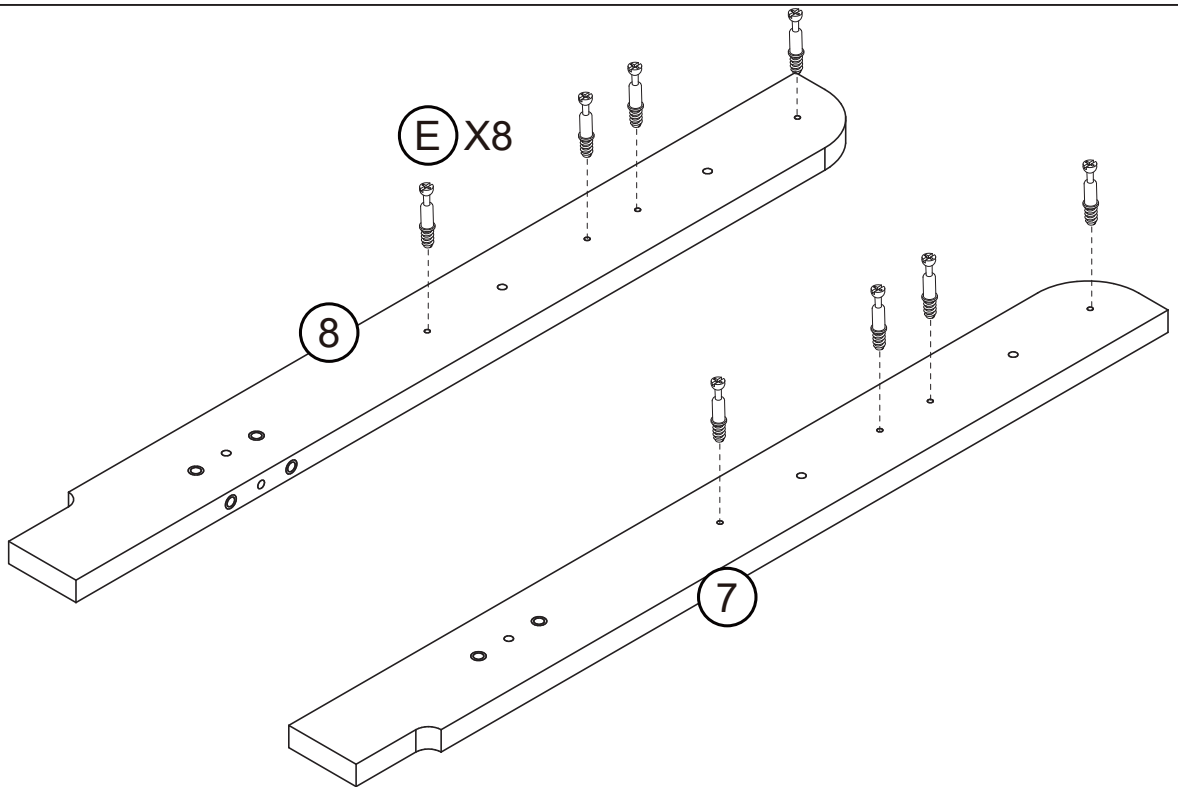

Assembly Instructions

Step 7

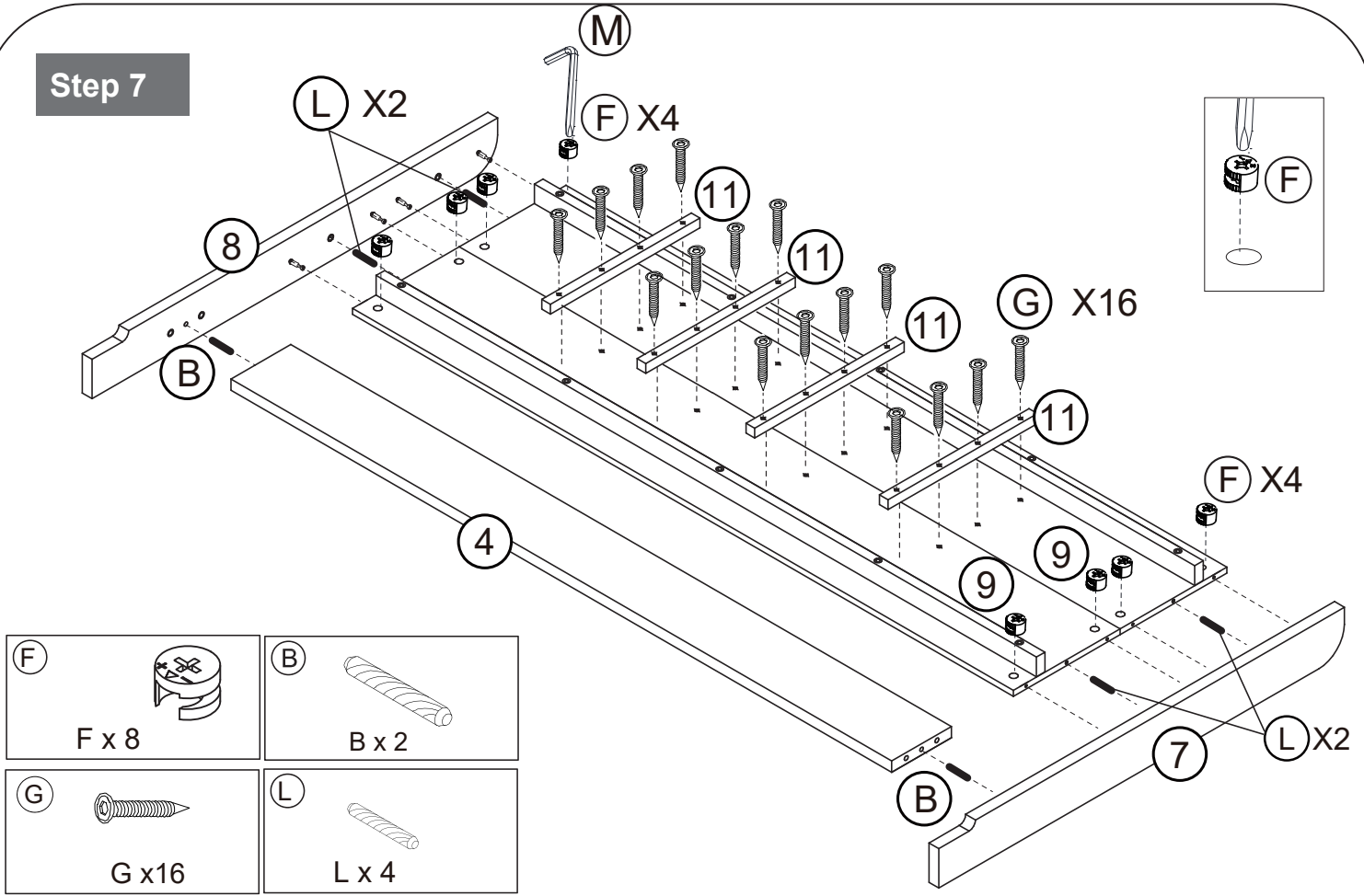

Step 8

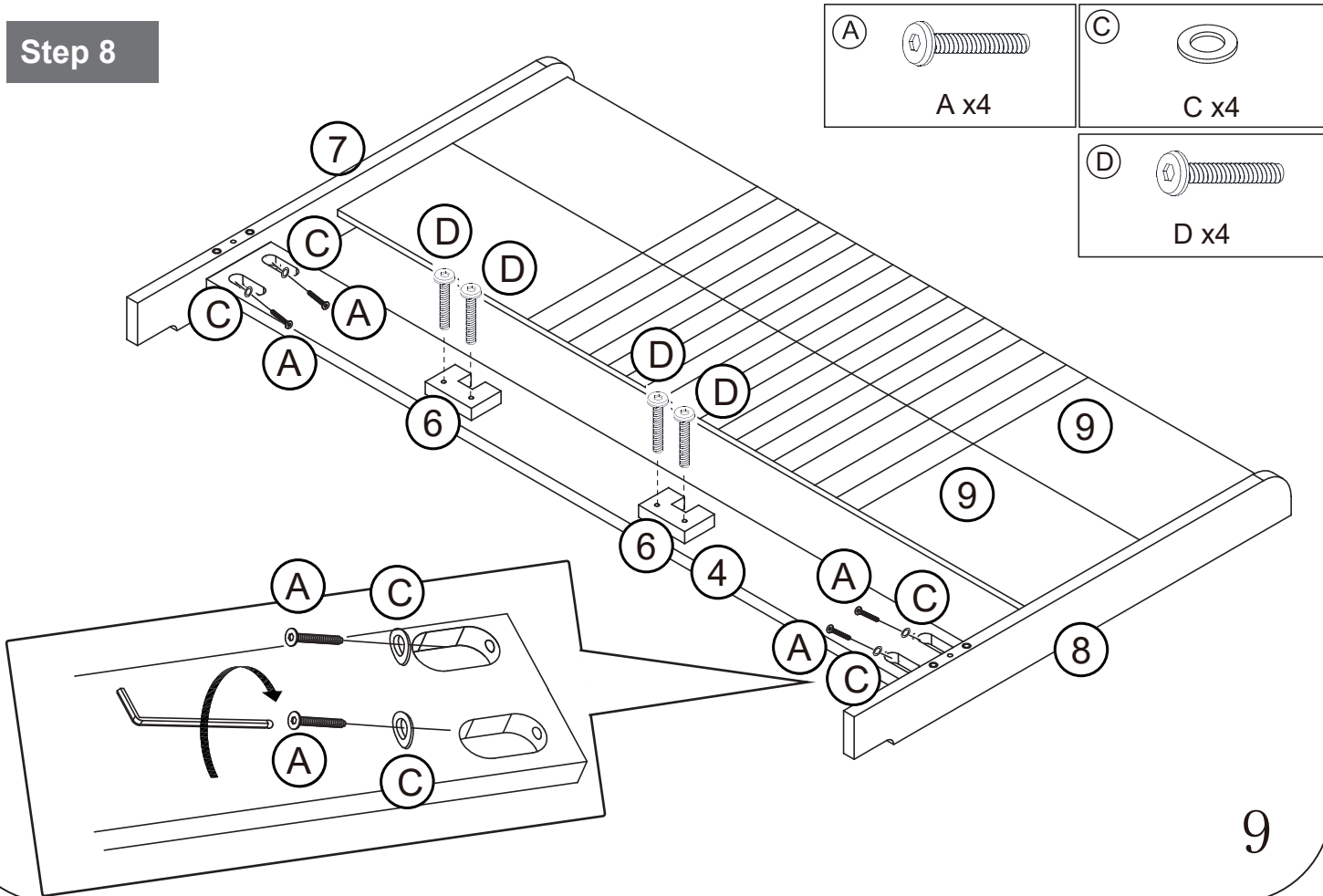

Assembly Instructions

Step 9

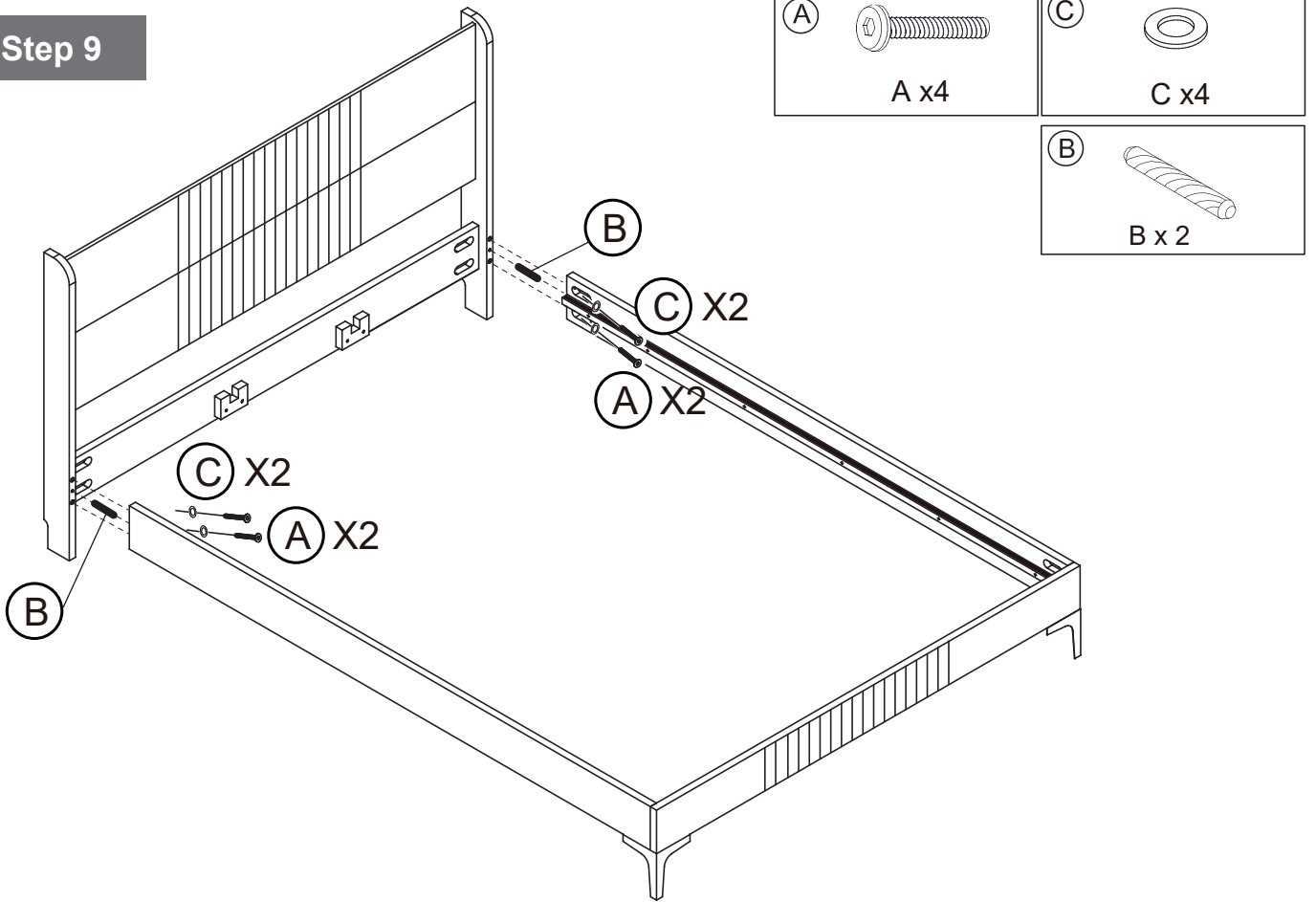

Step 10

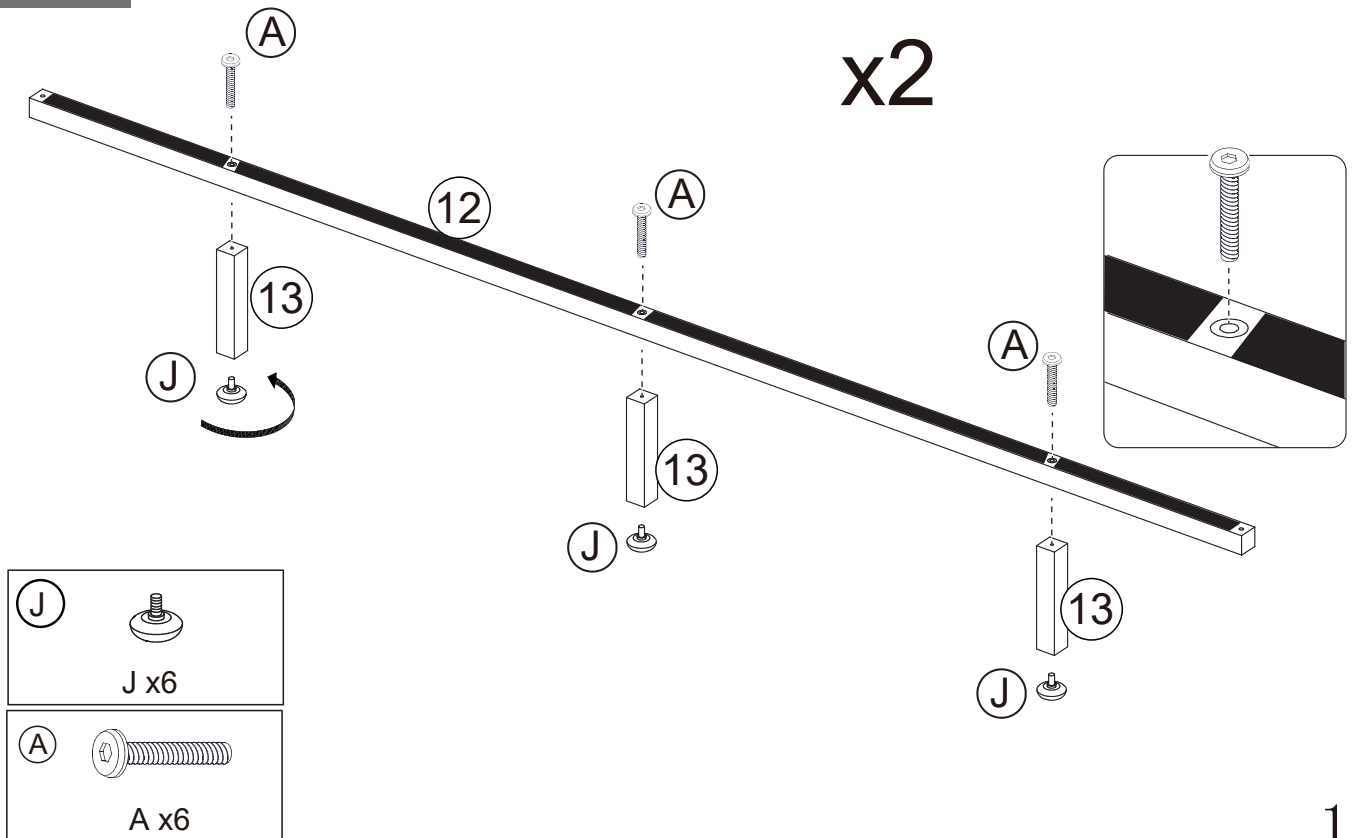

Assembly Instructions

Step 11

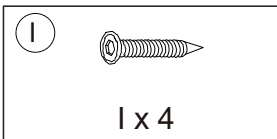
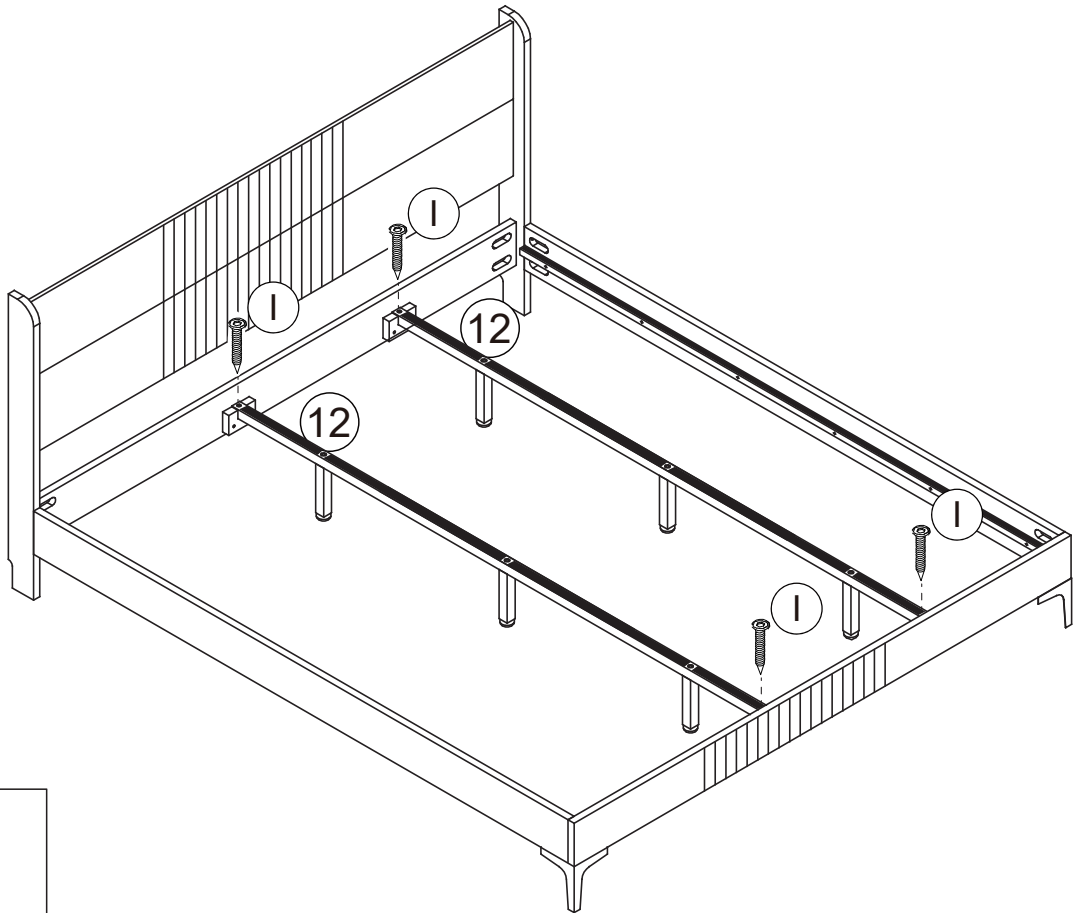

Step 12

