

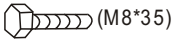

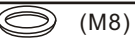







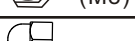
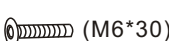











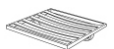

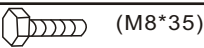
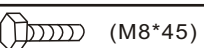
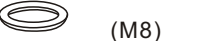
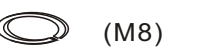

ASSEMBLY INSTRUCTIONS

Parts List			
Pieces	Schema	Description	QTY
A	 (M8*35)	Screw	2
B	 (M8)	Flat washer	2
C	 (M8)	Lock washer	2
D	 (M8)	Nut	2
E		Nut cap	2
K	 (M6*30)	Bolt	6
L	 (M6*45)	Bolt	4
M	 (M6)	Small flat washer	10
N	 (M6)	Small lock washer	10
O		PVC cover	10
P		Wrench	1
F		Wrench	1
H	1 	TR	1
	2 	Base	1
	3 	Oil cap	1
I		PE cap	6
J		Back Cushion	1
J1		Seat Cushion	1

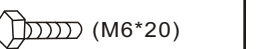
Parts List			
Pieces	Schema	Description	QTY
G	1 	Seat frame	1
	2 	Back frame	1
	3 	Arm left	1
	4 	Arm right	1
	5 	Alu plate	2
	6 	Alu plate	2
	7 	Spring plate	2
	8  (M8*35)	Screw	4
	9  (M8*45)	Screw	4
	10  (M8)	Flat washer	8
	11  (M8)	Lock washer	8
	12  (M8)	Nut	8
	13 	Nut cap	8
	14  (M6*20)	Screw	2
	15  (M6)	Flat washer	2
	16  (M6)	Lock washer	2
	17 	Adjusting block	2
	18 	Assembly	1

ASSEMBLY INSTRUCTIONS

1

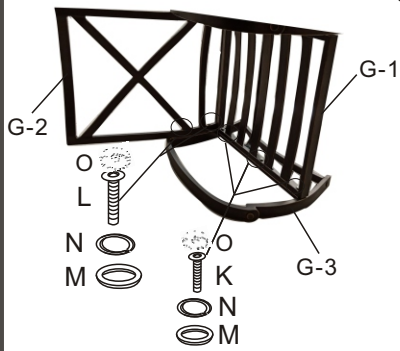

2

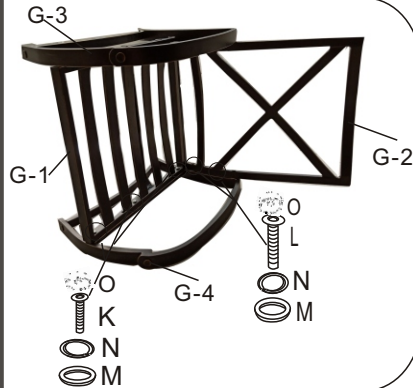

3

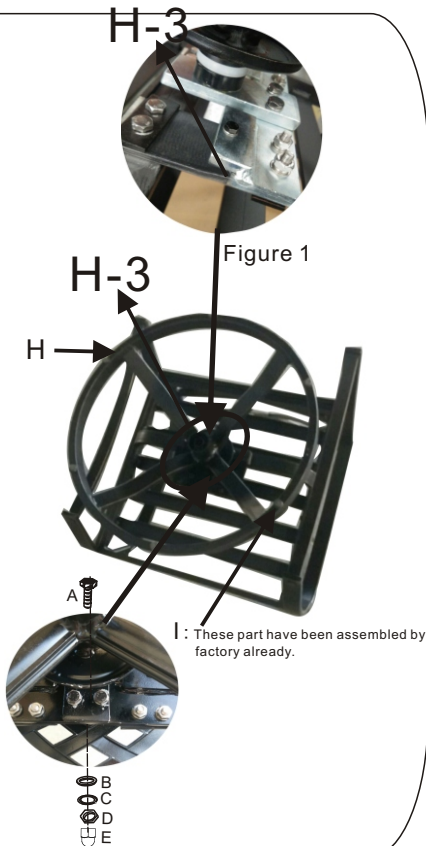

4



WARNING!

- This chair has a 275lbs weight capacity.
- If cushion gets wet, hang over chair to dry to prevent mold/mildew.

ATTENTION:

1. Please read these instructions carefully before assembly.
 2. Check parts against the parts list to make sure you have all parts needed for proper assembly.
 3. Familiarize yourself with the inventory of parts and the accompanying illustrations to ensure safe and proper assembly.
1. Before removing all protective packing material and position base on floor, Loosely attach the back frame (G-2) and the seat frame (G-1) on the left arm (G-3) with bolt (K&L), flat washers (M), lock washer (N), and PVC cover (O).
 2. Loosely attach the right arm (G-4) to the seat and back frame with bolt (K&L), flat washers (M), lock washer (N), and PVC cover (O). DO NOT tighten the nuts.
 3. Attach the base (H) onto the assemble the upper seat using bolt (A), flat washers (B), lock washers (C), nuts (D) and nut cap (E). Be sure to the arrows face to front.
 4. Tighten all the bolts and nuts. Test the swivel rocker gently. If the rocker does not rock properly, double check the assembly procedure.
 5. Remove all protective packaging.
 6. If the back rocking mechanism is too tight, you can loosen it by removing the adjusting block (G-17) on the bottom of the TR. Please make sure proper assembly is done after adjusting the tightness. See figure 1
 7. Put Cushion (J&J1) on the unit (as shown in the picture)

Warning: DO NOT use acid or alkaline washing liquid to clean the product.