

1. Do not touch the mirror with wet hands or wipe the mirror with a damp cloth to avoid increasing the moisture pouring in;
2. Keep the mirror away from salt, grease and acid, which can corrode the mirror;
3. The mirror should be wiped with soft dry cloth or cotton to prevent the mirror from being scratched or damaged;
4. Do not use acidic liquids to wipe mirror surfaces and frames;
5. Before bath, soap can be daubed mirror, then wipe with dry cloth, the mirror on the formation of a soap liquid film, can prevent mirror blur;
6. Dip in a dry cloth with proper amount of detergent and evenly wipe the mirror surface;
7. Use paper towel to wipe.

Model:803624

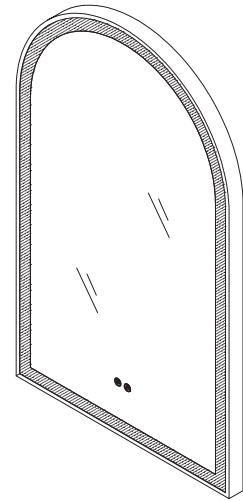

Mounting Tools

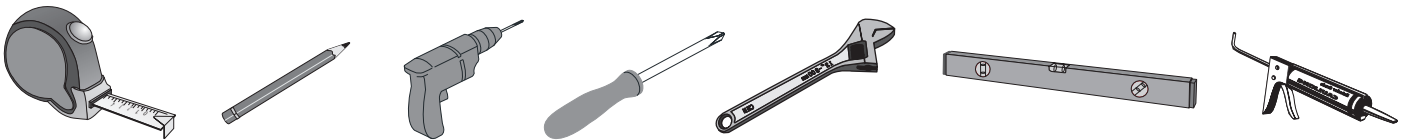

Dimensions

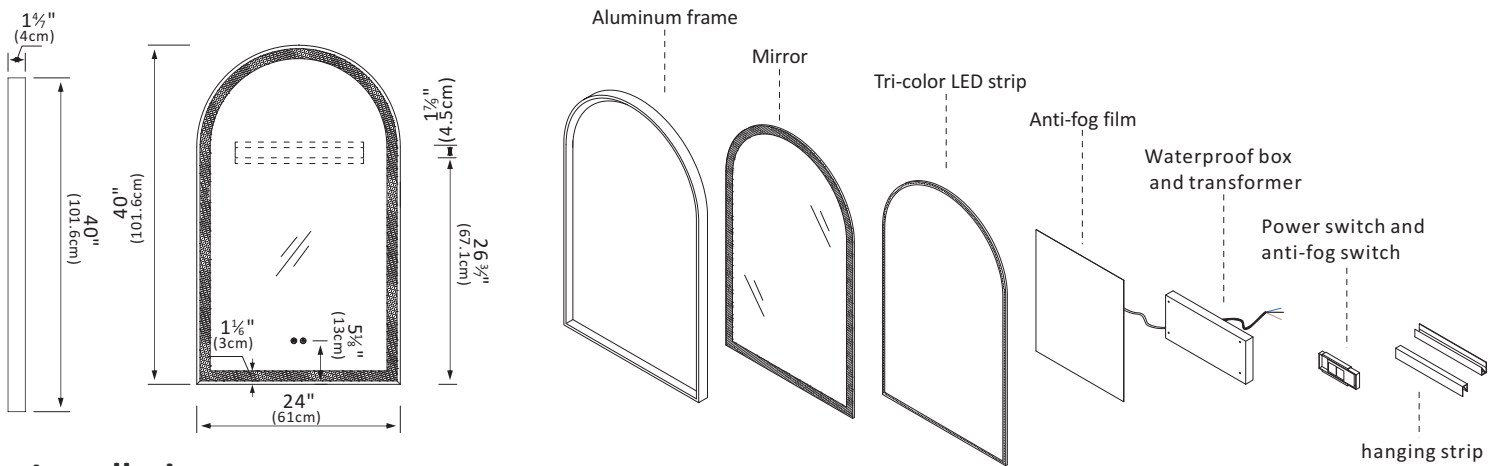

Installation steps

