

**EN\_IMPORTANT, RETAIN FOR FUTURE REFERENCE: READ CAREFULLY.**

**FR\_IMPORTANT: A LIRE ATTENTIVEMENT ET À CONSERVER POUR CONSULTATION  
ULTÉRIEURE.**

**ES\_IMPORTANTE, LEA Y GUARDE PARA FUTURAS REFERENCIAS.**

**DE\_WICHTIG! SORGFÄLTIG LESEN UND FÜR SPÄTER NACHSCHLAGEN AUFBEWAHREN.**

**IT\_IMPORTANTE! CONSERVARE IL PRESENTE MANUALE PER FUTURO RIFERIMENTO E  
LEggerlo ATTENTAMENTE.**

**A x1**

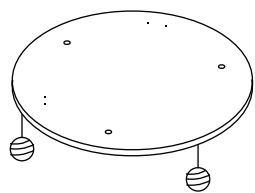

**B x1**

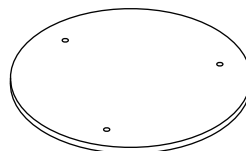

**P1 x1**

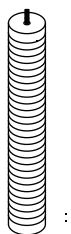

**P2 x1**

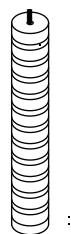

**P3 x1**



**W1 x3**



**W2 x1**



M8\*35mm

**01**

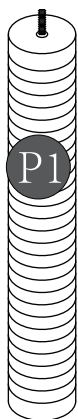
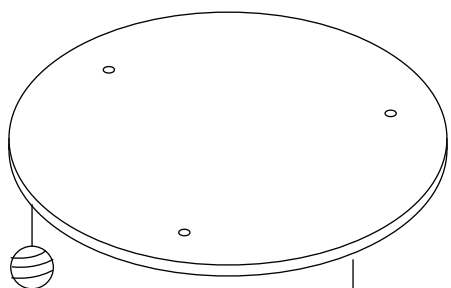

**02**

**W1 x3**

M8\*35mm

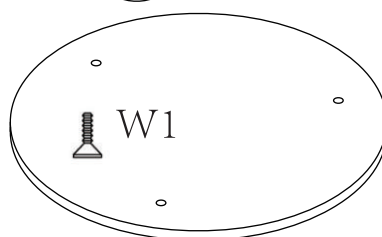
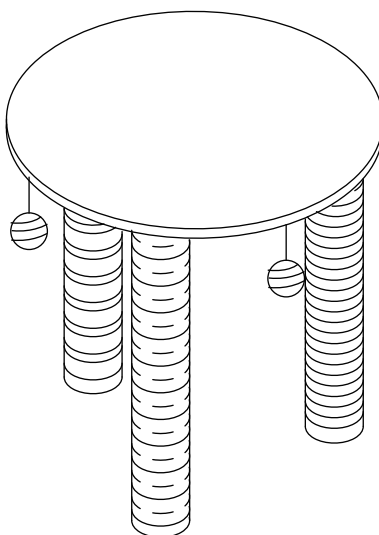

W1

W1