

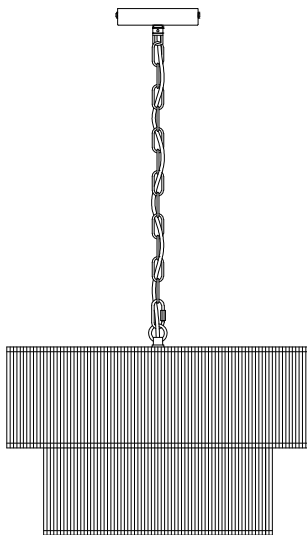

Chandeliers

SKU: HCDL20A
[Instruction Manual]



Please pay attention to the warning signs
Read the instructions with caution before operating
and keep it properly

Warning:

Risk of fire. Min 167°F/75°C supply conductors. Consult a qualified electrician to ensure correct installation. Before installation, please turn off the main power of the circuit breaker to prevent possible electric shock.

Installation Instructions

FIG.1. Turn the wall switch to the "OFF" position. Depending on which type of fuse box in your home:

FIG.2. Either turn the main (Master) switch to the "OFF" position to cut off the power supply of the entire home, or turn off the individual switch that supplies power to where the fixture will be installed.

OR

FIG.3. Either turn the main (Master) switch to the "OFF" position to cut off the power supply of the entire home, or unscrew the fuse that supplies power to where the fixture will be installed.

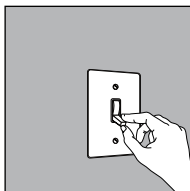

FIG.1 WALL SWITCH

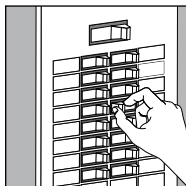

FIG.2 BREAKER PANEL

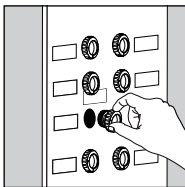
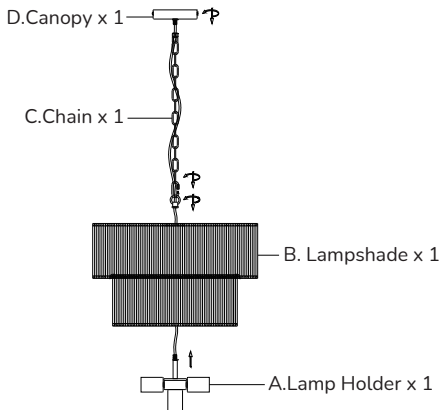







FIG.3 FUSE BOX

PACKING LIST



- 1.Feed wires of Lamp Holder (A) through the hole in Lampshade (B) washer, then hang Chain (C) eyebolt onto Lamp Holder (A) teeth and tighten.
- 2.Engage Chain (C) movable lock and feed wires through Chain (C) and Canopy (D).
- 3.Snap Canopy (D) teeth onto Chain (C) and tighten.

INSTALLATION KIT

AA x1  Mounting Bracket	BB x3  Wire Nut	CC x2  Outlet Box Screw	DD x1  Ground Screw
EE x2  Mounting Bracket Screw			

1. Ground Screw (DD) ,Mounting Bracket Screw (EE) have been pre-installed on Mounting Bracket (A) .
2. Wire Nut (BB) and Outlet Box Screw (CC) are accessory packages.

INSTALLATION

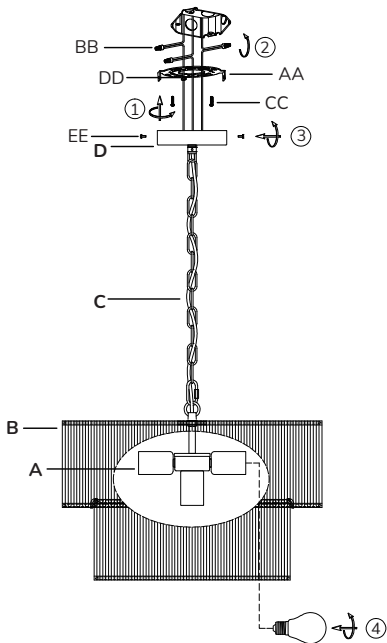

Step 1: Mount the Bracket

1. Loosen the Mounting Bracket Screw (EE) from Canopy (D), and take out the Mounting Bracket (AA).
2. Take off the screws from the outlet box, and secure the Mounting Bracket (AA) onto the box with the screws taken off or Outlet Box Screw (CC).

Step 2: Make Wire Connections

1. Wrap the outlet box ground wire around the Ground Screw (DD) on the Mounting Bracket (AA), then connect the fixture ground wire to the outlet box ground wire.
2. Connect fixture wires to house supply wires: white (neutral) to white, black (hot) to black.
3. Separate the wires: place hot wires on one side of the outlet box and neutral wires on the other.

Step 3: Secure the Canopy

1. Fix the Canopy (D) onto the Mounting Bracket (AA) with the Mounting Bracket Screw (EE).

Step 4: Install Bulbs

1. Install the E26 x4 bulbs (not included).

Specifications

- Input Voltage: 120VAC 60Hz
- Max.Load Power: incandescent Bulb 60W
- Socket Type: Standard Medium E26

One Year Limited Warranty

Supported by our professional R&D team and QC team, we provide One Year Warranty for materials and workmanship from the purchase date. Please note that the warranty does not cover damage caused by personal misuse or improper installation. Please attach your Order ID and Name so that our dedicated customer service team can help you better.



Made in China