

①canopy 1PCS

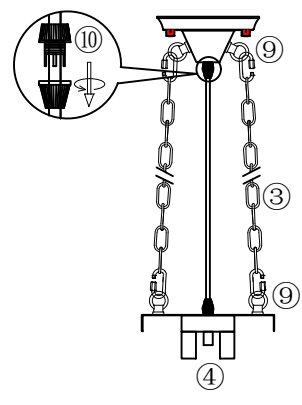

1. Hang the fixture ④ to the canopy ① with chain ③, let the wire go through the canopy ①, adjust the height of the wire with threaded cord grip ⑩.

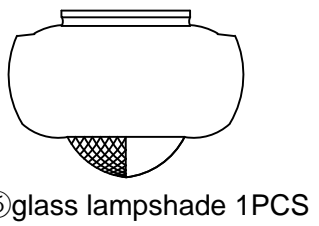
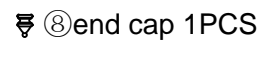
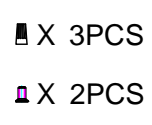
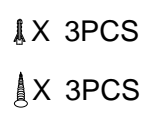
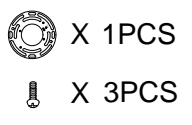
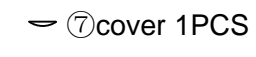
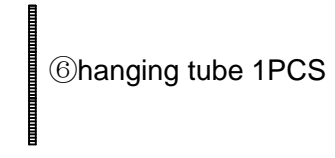
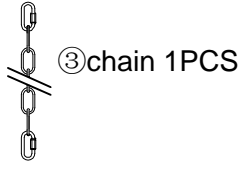
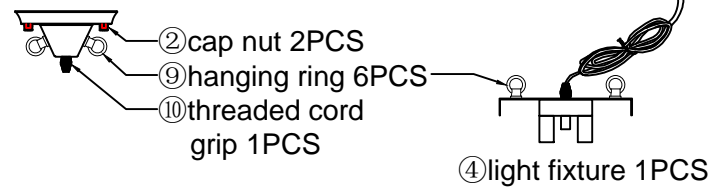
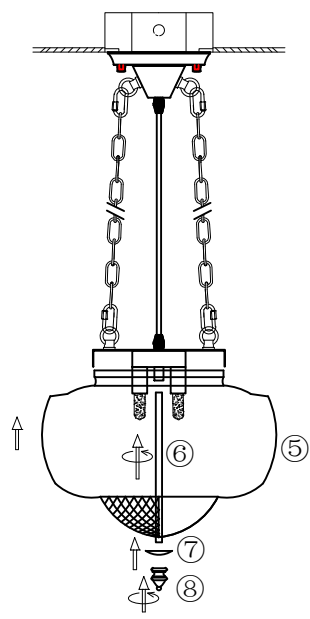
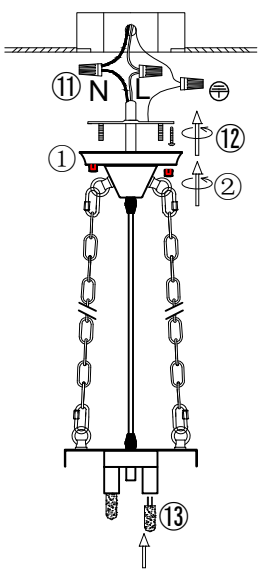

2. Install the bracket to the ceiling junction box with screw ⑫.
 3. Connect the wire to the home line with cap connector ⑪.
 4. Install the fixture to the bracket with cap nut ②.
 5. Install the bulb ⑬.

6. Rotate to install the tube ⑥ to the fixture, after that install the lampshade ⑤ to the fixture with cover ⑦ and end cap ⑧.

Please read carefully before installation!!!
 Note : Please make sure that the electricity is powered off during installation !
 Only a professional electrician should install this kind of product !