

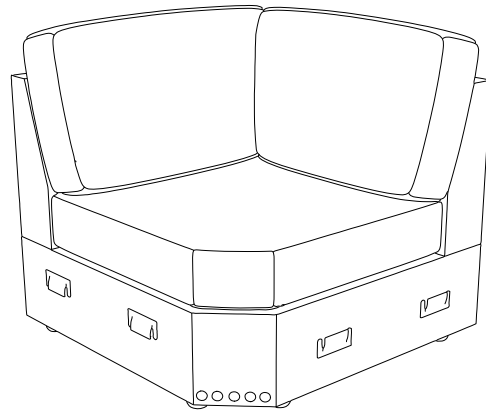

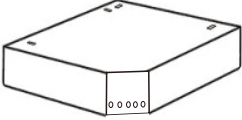

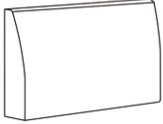

ASSEMBLY INSTRUCTION

ITEM NO.: D6915-C

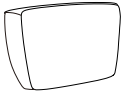

PARTS LIST

 A x1	 B x1	 C x1	 D x1		
 E x1	 F x1				
 1 x4	 Leg x5				

BEFORE ASSEMBLY

Open up Velcro of Non-Woven Fabric cover on the bottom to remove hardware, legs and parts.

1. Please open the black woven fabric with Velcro closure on the bottom of the frame then cut off the black straps before removing the parts for assembly.
2. After removing the cushion from the compress bag, please allow air to flow through the cushion for few days. You can try to fluff cushion by push in and push out on all four sides of the cushion. Hitting the top/front of the cushion with your hand to fluff them after installation.
3. Please allow at least 24 hours for the cushions to recover to its natural state after removing from the package.

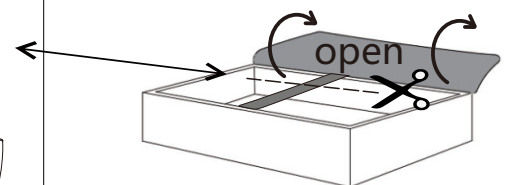
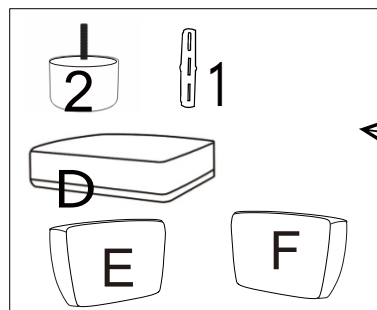

SOFA ASSEMBLY INSTRUCTION

Step1

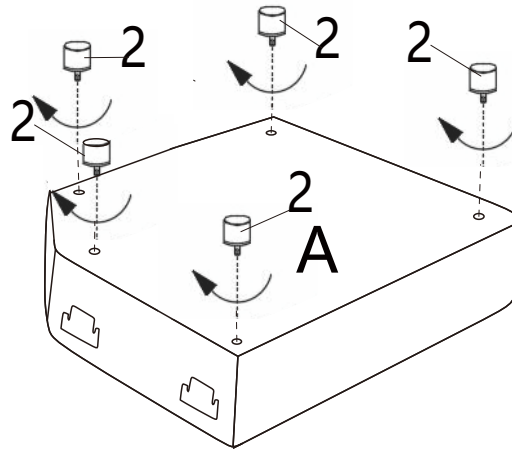

Step2

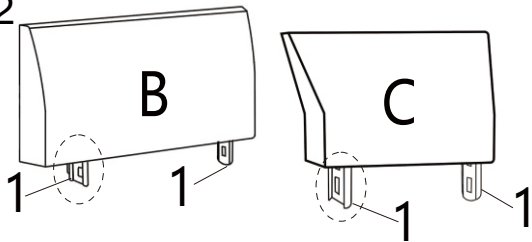

wrong!

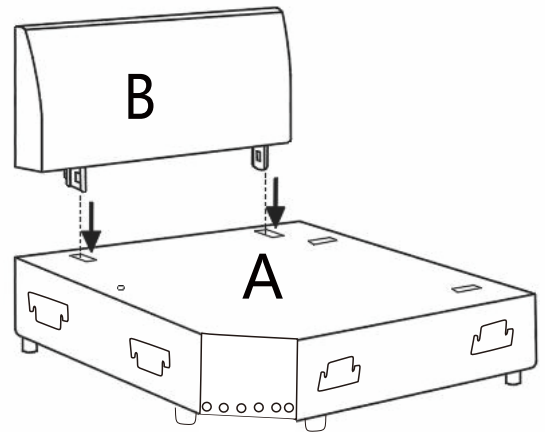
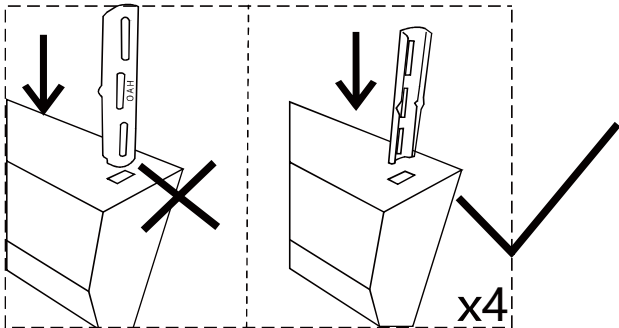

Step3

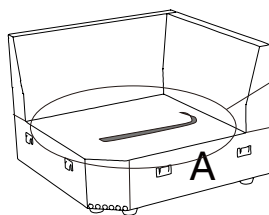
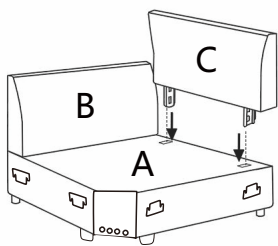

Please kindly remove the black cover tape from the velcro before you place the cushion on top.

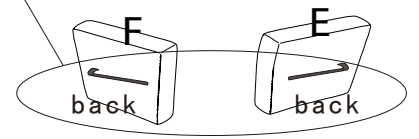

Step4

