























Assembly Instructions

Care & Maintenance

 	<ul style="list-style-type: none">● Not for commercial use. For residential use only.
 	<ul style="list-style-type: none">● Furniture may scratch floors. We recommend using furniture pads to protect your floors.
 	<ul style="list-style-type: none">● Do not put hot items directly on furniture surface.
 	<ul style="list-style-type: none">● Do not clean furniture with harsh cleansers or polish.
 	<ul style="list-style-type: none">● Do not place furniture under direct sunlight.
 	<ul style="list-style-type: none">● Do not place furniture near heating or cooling vents.
 	<ul style="list-style-type: none">● Do not write on furniture without a padded barrier to protect the surface.
 	<ul style="list-style-type: none">● Do not place furniture outside. For indoor use only.
 	<ul style="list-style-type: none">● Stains may be removed with mild soap solution and damp cloth.
 	<ul style="list-style-type: none">● Children should not climb or jump on the furniture.
 	<ul style="list-style-type: none">● Dust and pick-up spills using a clean, non-colored, lint-free cloth.



Please look in the box for hardware packs and legs.

Sets often ship in multiple boxes and may arrive a day or two apart.

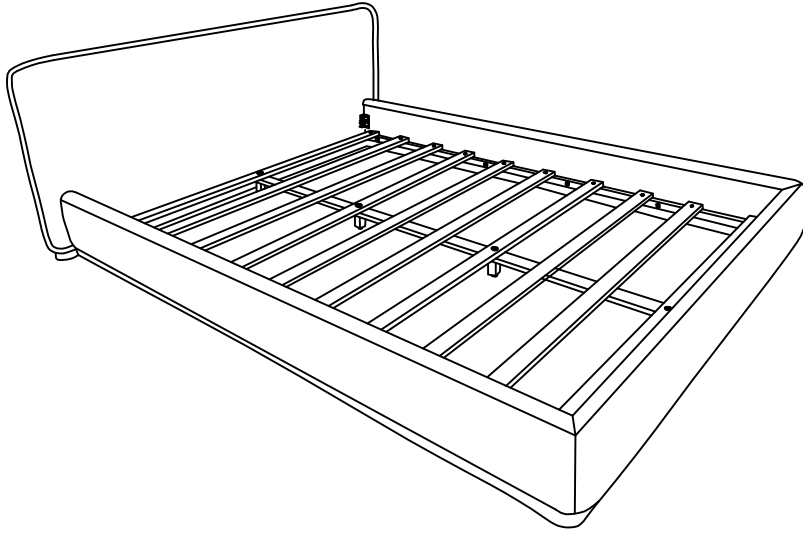
Queen Bed



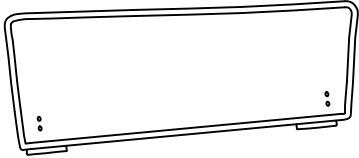
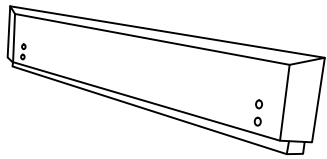
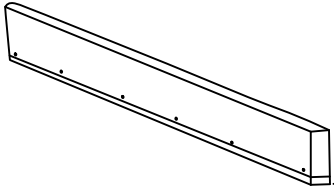
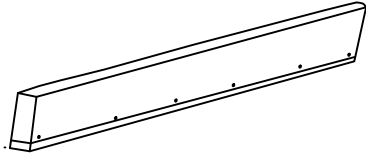



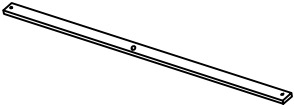
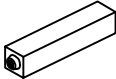
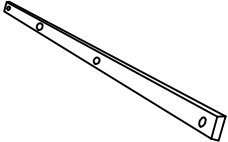
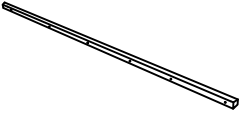

Part List

Label	Picture	Description	QTY
①		Headboard	1
②		Footboard	1
③		Side Rail(R)	1
④		Side Rail(L)	1
⑤		Slats	6

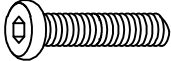
Part List

Label	Picture	Description	QTY
⑥		Slats	4
⑦		Center Support Leg	4
⑧		Center Support Slat	1
⑨		Support Rail	2



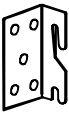
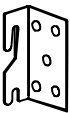
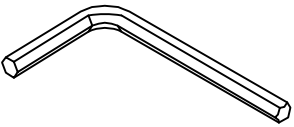



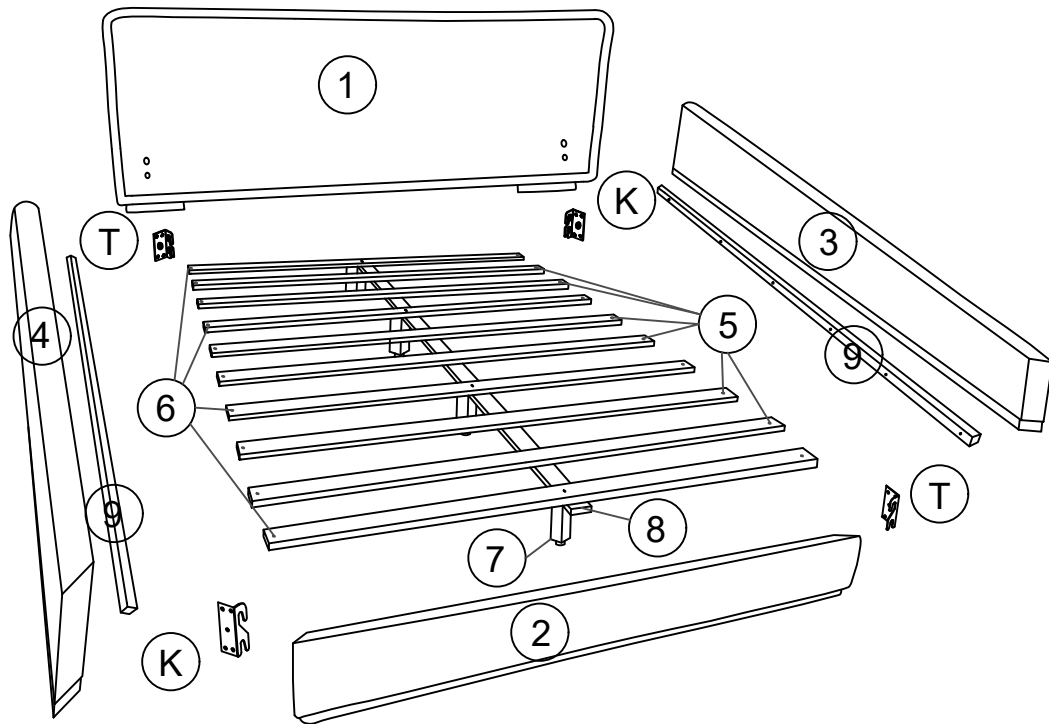

Hardware





Label	Picture	Description	QTY
(A)		Screw(4x30mm)	36+1
(B)		Bolts(5/16x30mm)	12+1
(C)		Bolts(5/16x50mm)	12+1
(D)		Bolts(1/4x50mm)	4+1
(E)		Lock washer(5/16x20mm)	24+1
(F)		Flat washer(5/16x20mm)	24+1
(G)		Lock washer(1/4x18mm)	4+1
(H)		Flat washer(1/4x18mm)	4+1
(T)		Metal Pad (L)	2
(K)		Metal Pad (R)	2
(M)		Allen wrench(M4)	1+1

Assembly Preparation

Before Beginning assembly:



A		(4x30mm)	x36pcs+1	F		x24pcs+1
B		(5/16x30mm)	x12pcs+1	G		x4pcs+1
C		(5/16x50mm)	x12pcs+1	H		x4pcs+1
D		(1/4x50mm)	x4pcs+1	M		x1pcs+1
E			x24pcs+1			

-  Read the instructions cover to cover
-  Have 2 adults on hand for assembly
-  Do not assemble on flooring or carpet
-  Assemble on a clean, non-marring surface (packing foam)
-  Save all packaging until finished

Assembly Steps

OVERVIEW

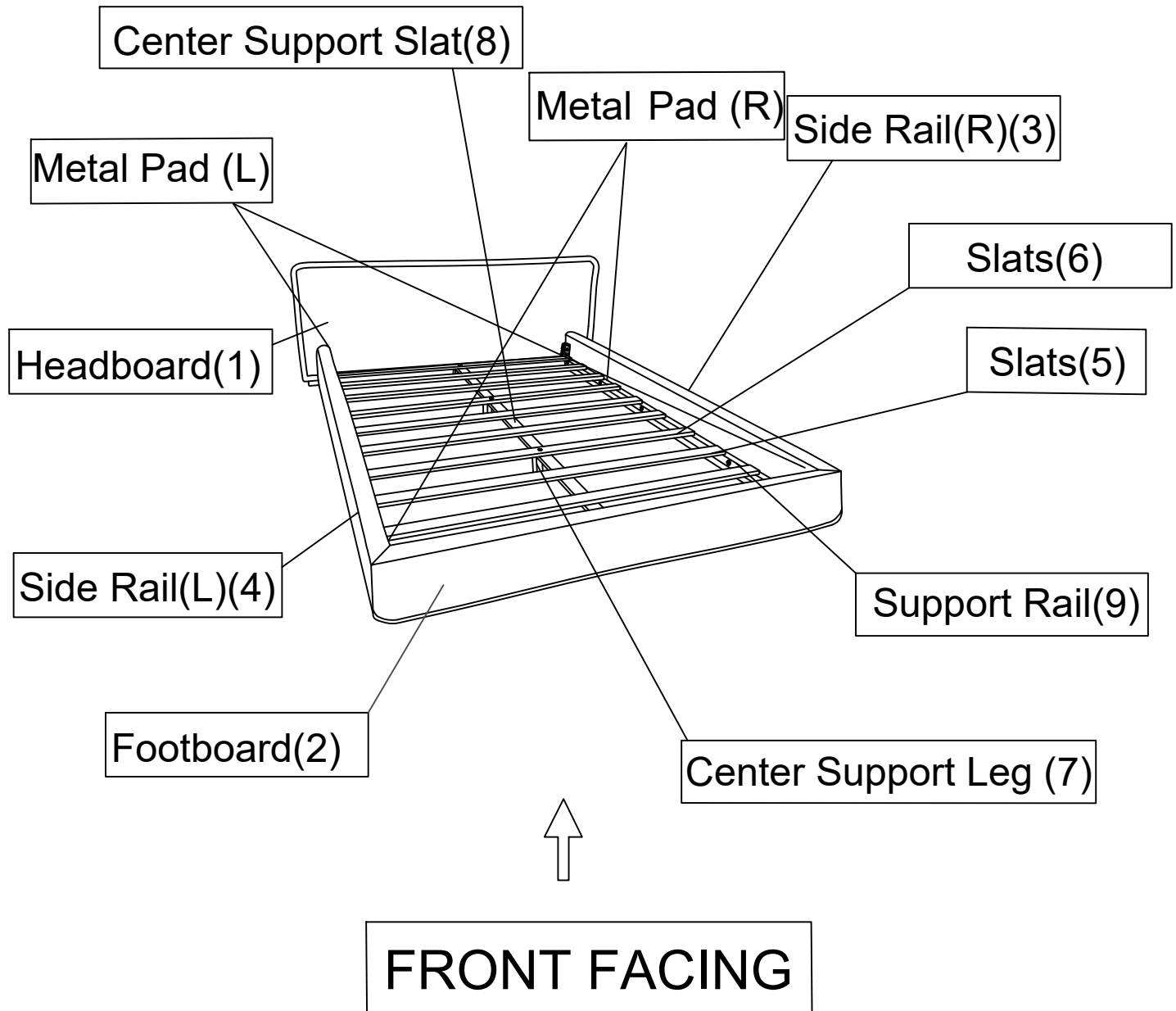

This Bed have multiple parts and may require up to 30 minutes to assemble. To give you an overview of the Bed parts, the above picture is to help you put the various parts into perspective. Please read through the instructions below to familiarise yourself with the parts and steps before assembly.

Note: It is recommended that you have an adult partner to assist during the entire assembly process.

Step1

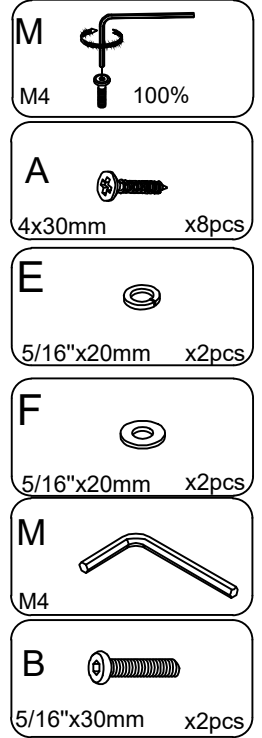
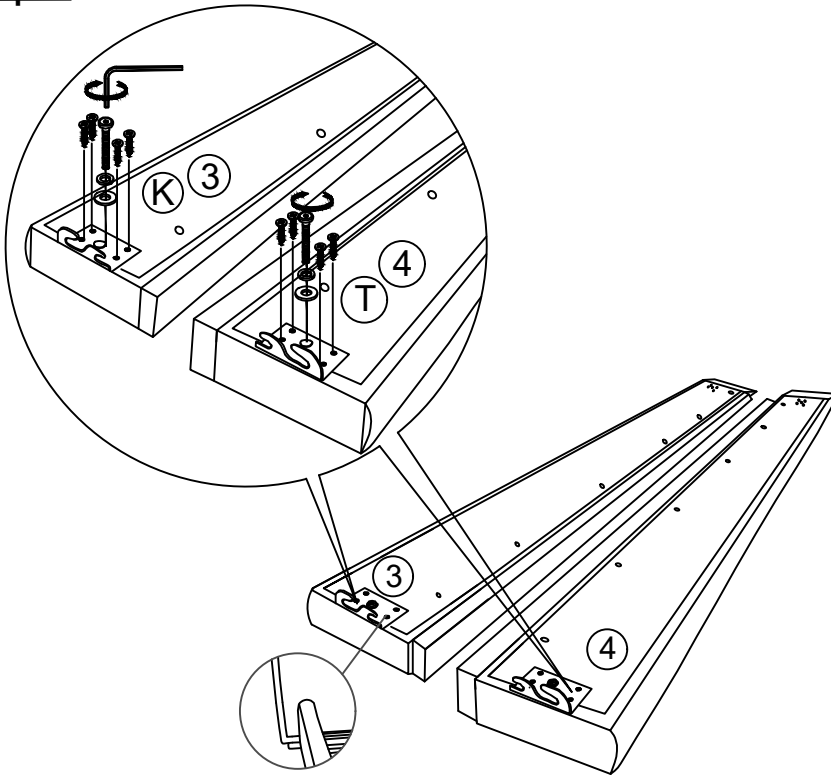

Step 1: Attach the Metal Pad (R) (K) to the Side Rail (R) (3), attach the Metal Pad (L) (T) to the Side Rail (L) (4). By using the Bolts (B) and the Lock Washer (E) with Flat Washer (F) ,Screw (A) with M4 Allen Wrench (M)
(Note: The Metal Pal hook is facing down and this place is connected to the Headboard (1))

Step2

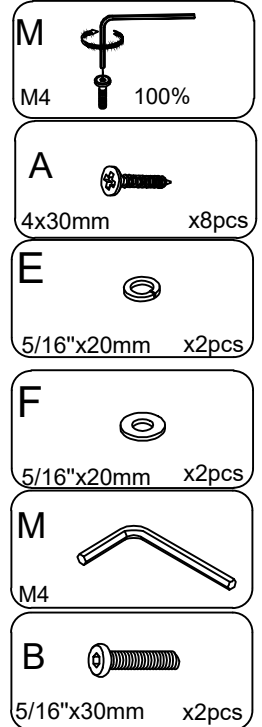
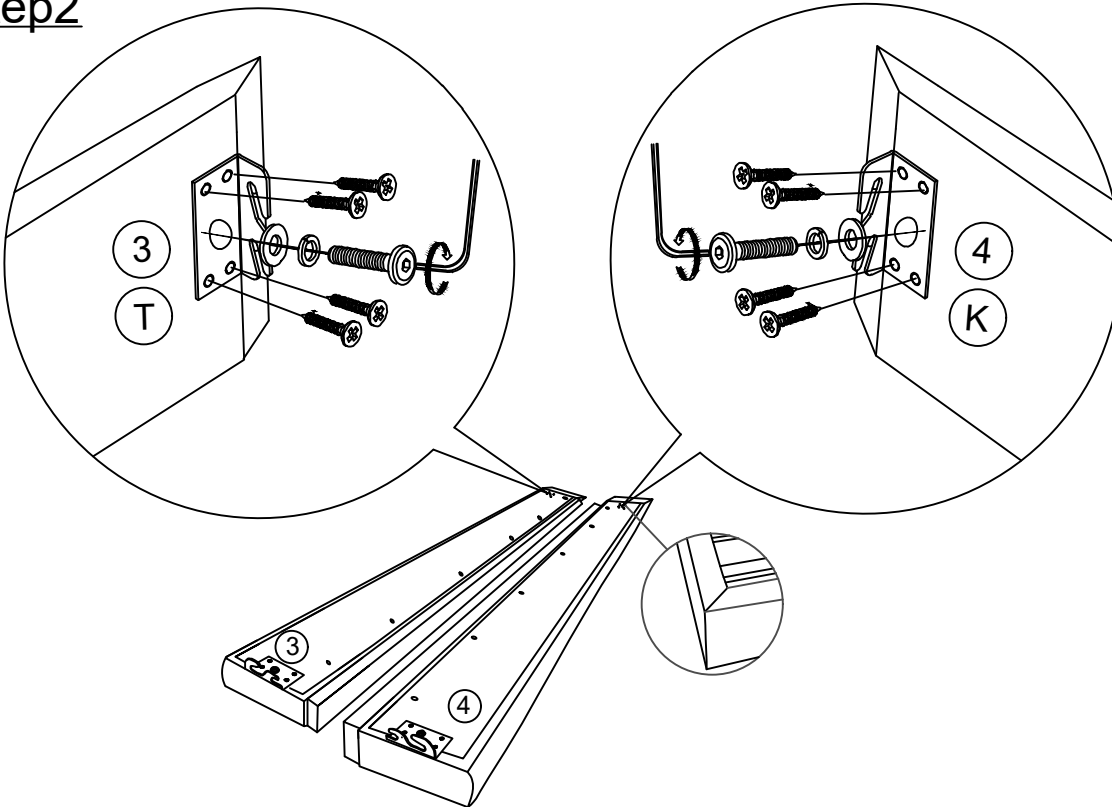

Step 2: Attach the Metal Pad (L) (T) to the Side Rail (R) (3), attach the Metal Pad (R) (K) to the Side Rail (L) (4). By using the Bolts (B) and the Lock Washer (E) with Flat Washer (F) ,Screw (A) with M4 Allen Wrench (M)
(Note: The Metal Pal hook is facing down and this place is connected to the Footboard (2))

Step3

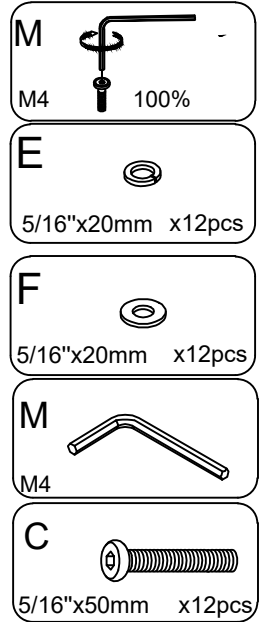
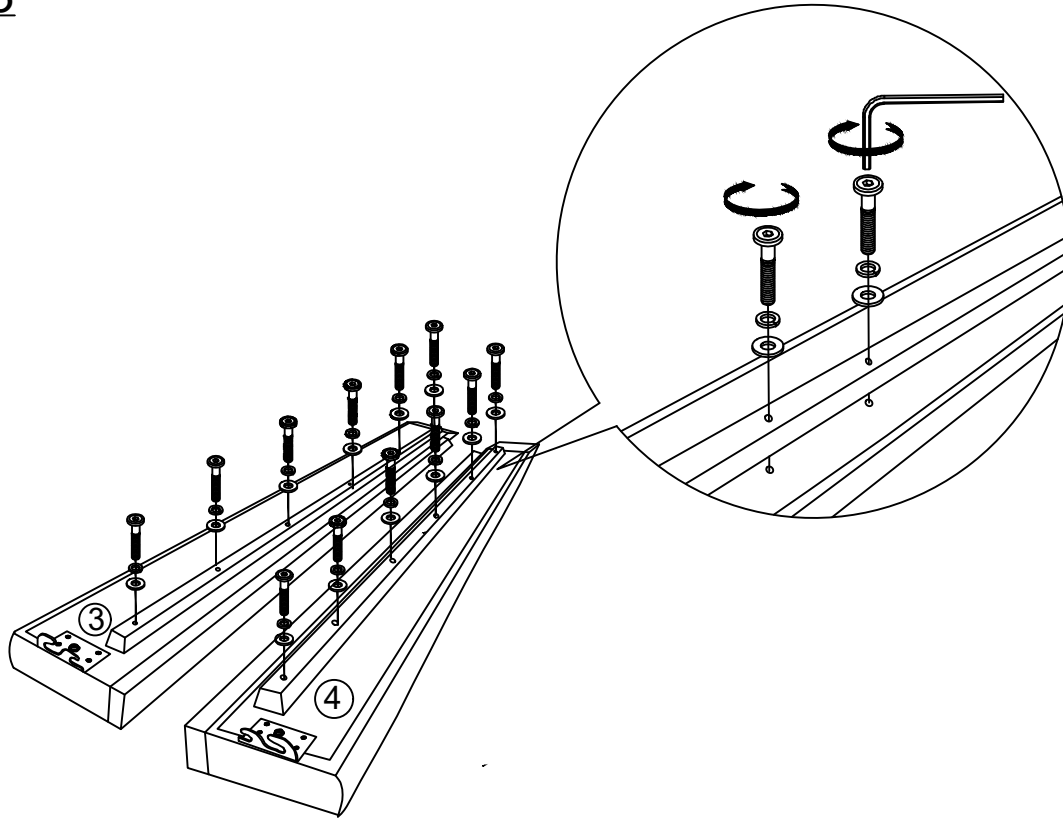

Step 3: Attach the Support Rail (9) to the Side Rail (R) (3) and the Side Rail (L) (4). By using the Bolts (C), the Flat Washer (F) and the Lock Washer (E) with M4 Allen Wrench (M) .

Step4

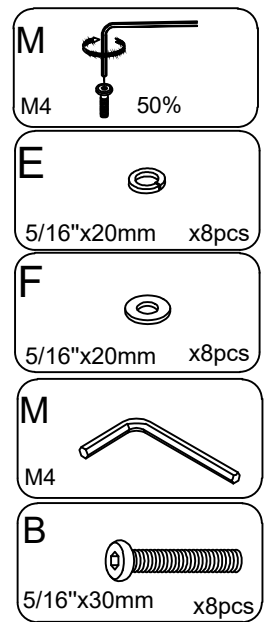
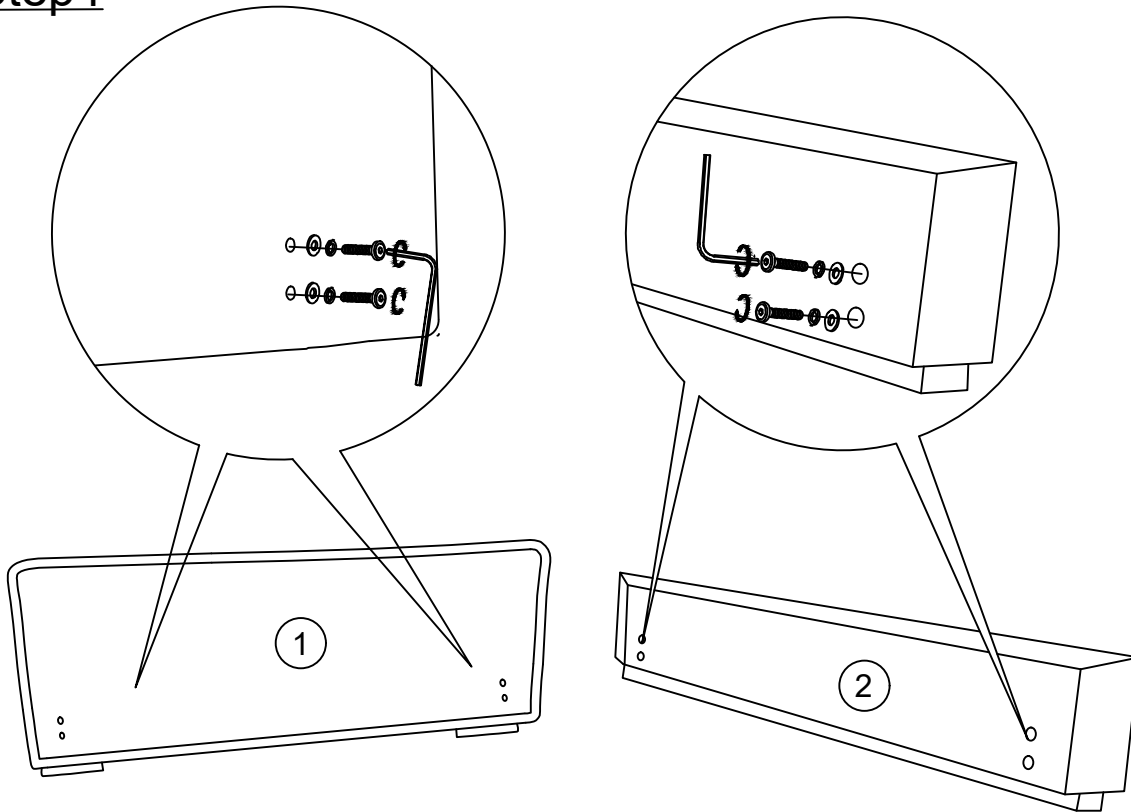

Step 4: Use the Bolts (B) and the Lock Washer (E) with Flat Washer (F) with M4 Allen Wrench (M) to the Headboard (1) and Footboard (2) (Note : Just attach 1/2 Bolts (B)).

Step5

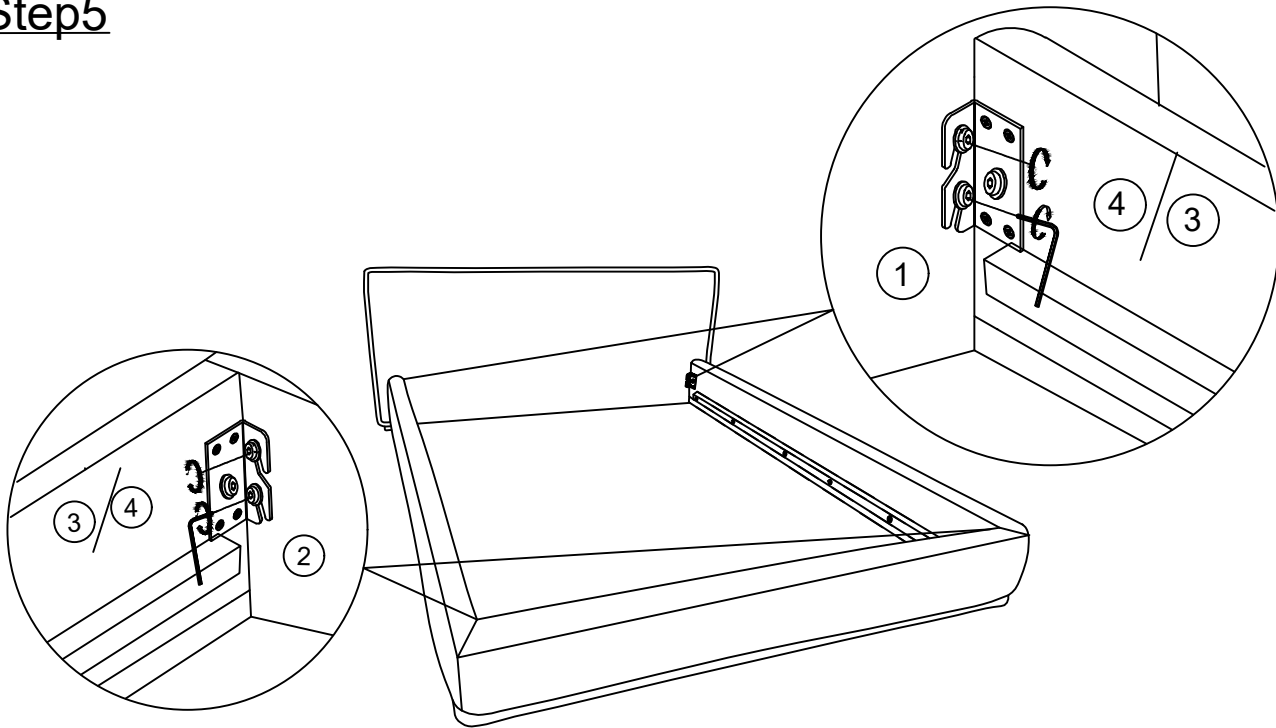

Step 5: Attach the Side Rail (R) (3) and the Side Rail (L)(4) to the Headboard (1) and the Footboard (2) by using the M4 Allen Wrench (M) to tighten the Bolts (B) 100%.

Step6

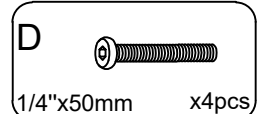
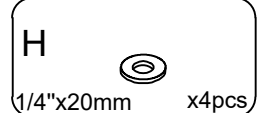
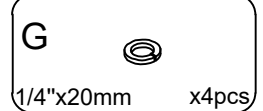
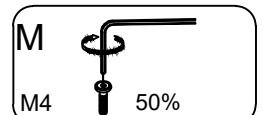
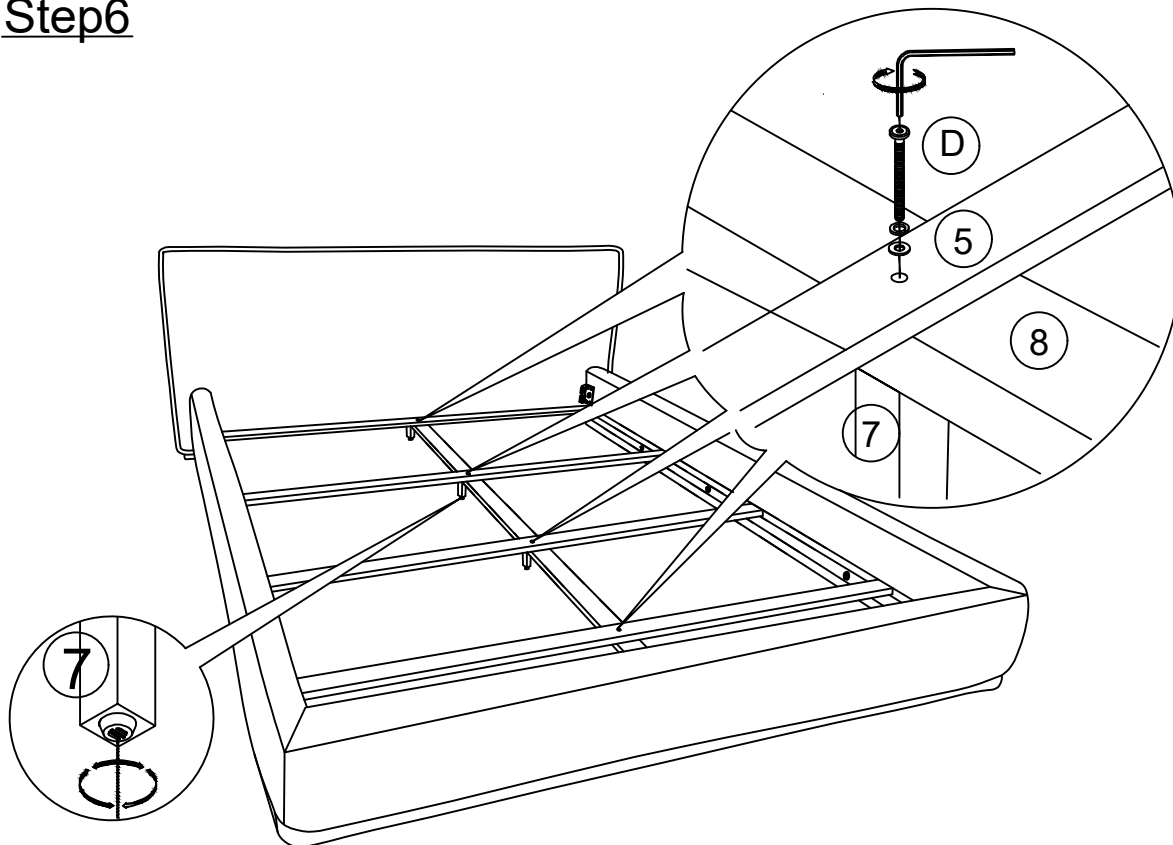

Step 6: Align the assembly position on the Center Support Slat (8) with the Center Support Leg (7) and the Slats (5).Then attach the Slats (5) and the Center Support Slat (8) to the Center Support Leg (7).By using the Bolts (D) with M4 Allen Wrench (M).

Step7

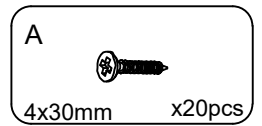
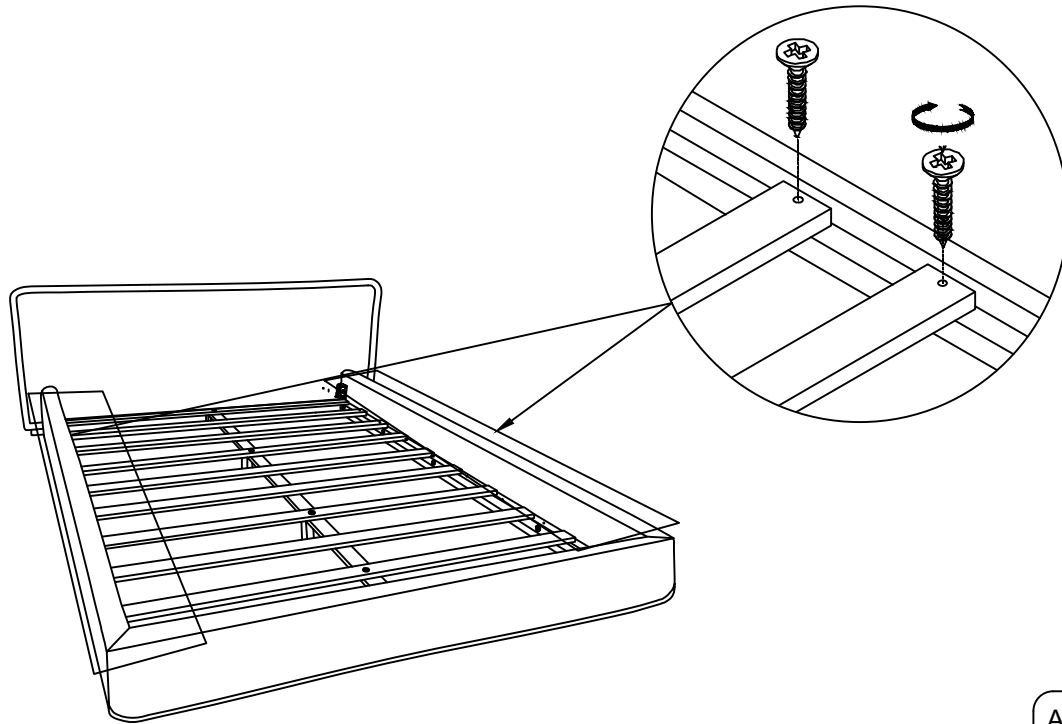

Step 7: Use the Screws (A) to fasten the Slats (5) and the Slats (6) to the Side Rail (R) (3) and the Side Rail (L) (4).

Step8

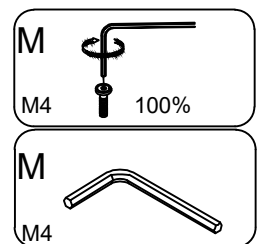
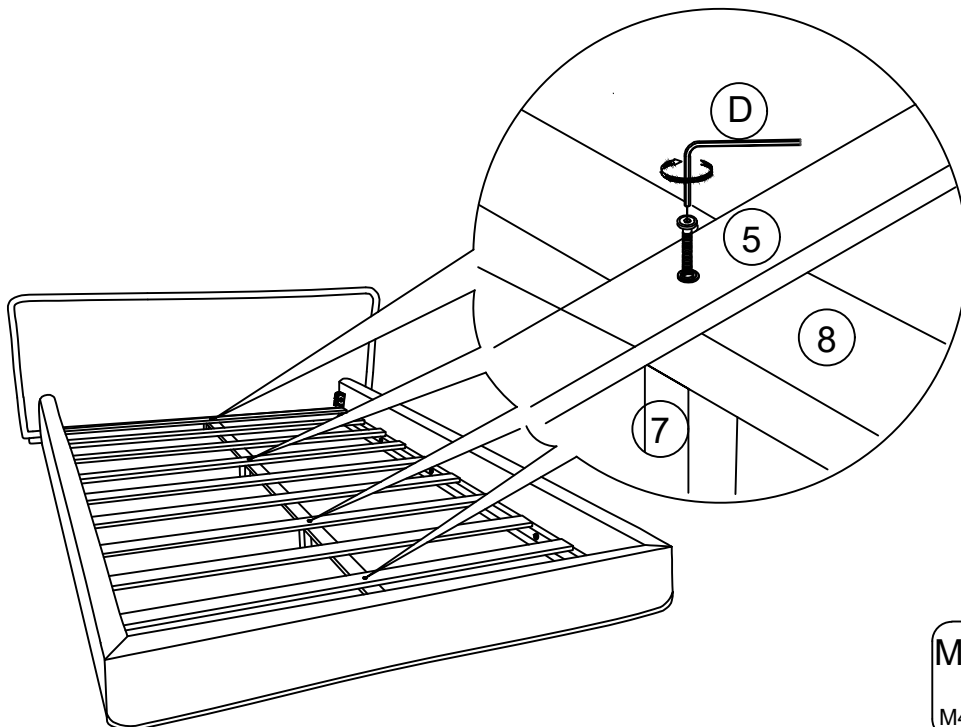

Step 8: Finally, use the M4 Allen Wrench (M) to tighten the Screw (A) 100%

Step9 Finished

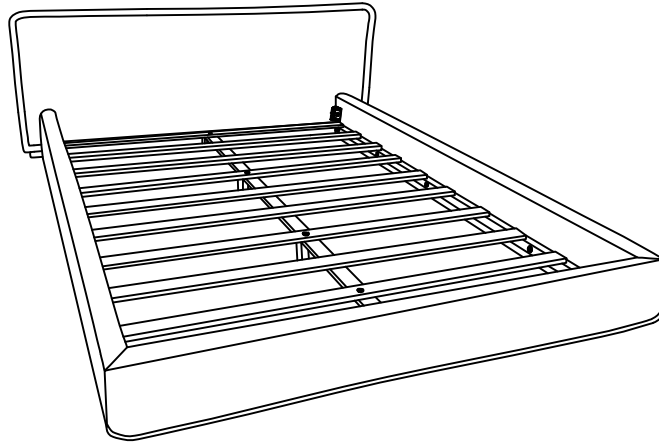

Thank you for your trust and preference in using our products. The product will bring you a peaceful sleep forever.