

Assembly & Instruction Manual

SKU: 800-192 Polycarbonate Roof Gazebo 10x12FT

Gazebo

Installation Guide

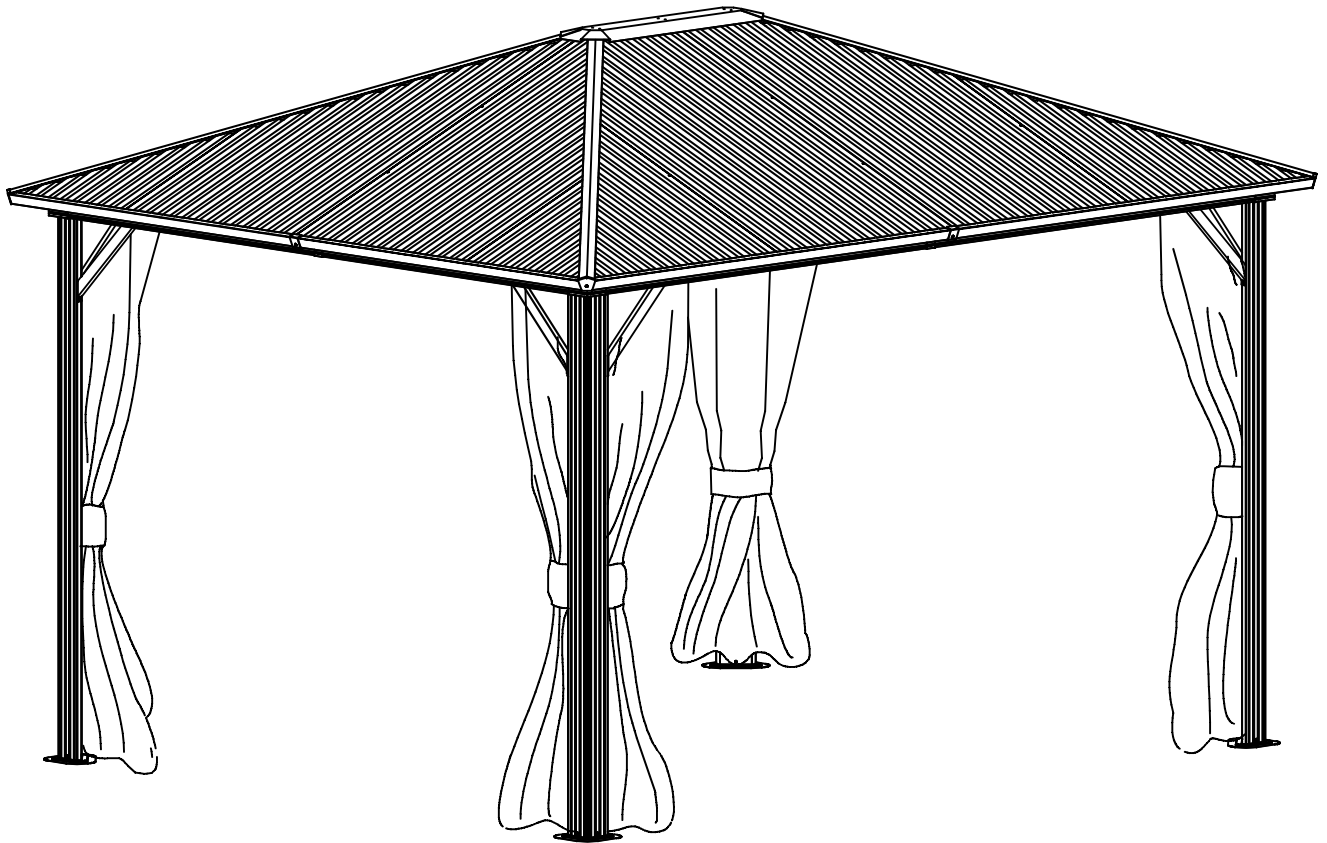

Version 20230616

Save this manual for future reference

INTRODUCTION

Thank you for purchasing Aoodor's Patio gazebo! We hope you will find joy in our product for many years to come.

To ensure your personal safety during installation and to get the most out of your investment, please read this entire manual before beginning the installation process. If you feel that this process is too difficult to do on your own, we advise that you seek assistance from a local building or home improvement contractor.

! **WARNING** Improper installation and operation of your gazebo can result in severe personal injury as well as product failure not covered by warranty. Please follow all instructions carefully or contact technical support for assistance.

We believe that installation can be a simple, streamlined process if you follow the instructions in this manual. Please contact our customer support line for help any step of the way. If you need assistance with assembly, have missing or defective parts, or any other issues, please email us at customerservice@aoodor.com

! SAFETY INFORMATION

Please read and understand this entire manual before attempting.

Three people are need for assembly.

Maximum load for the roof hook: 50 lbs.

Estimated assembly time:2-3hours.

PREPARTION

Before beginning assembly of product, make sure all parts are present. Compare parts with package contents list and hardware contents list. If any part is missing or damaged, do not attempt to assemble the product.

Product is NOT INTENDED for the following:

- A safety barrier to prevent unsupervised access to pools, hot tubs, spas or ponds.
- As load bearing support for a building, structure, heavy objects or swings.
- Used in structures that trap wind, rain or snow that would create extra load on the product.

Accumulated snow must be removed from roof.

DO NOT climb or walk on roof for any reason.

Permanent structures may require a building permit. As the purchaser and or installer of this product you are advised to consult local planning, zoning and building inspection departments for guidance on applicable building codes and/or zoning requirements.

Wood is NOT flame retardant and will burn. Grills, fire pits and chimineas are a fire hazard if placed too close to structure. Consult user's manual of the grill, fire pit or chimnea for safe distances from combustible materials.

Wear gloves to avoid injury from possible sharp edges of individual elements before assembly.



During installation, follow all safety warnings provided with your tools and use Safety glasses. Some structures may require two or more people to install safely.

Check for underground utilities before digging or driving stakes into the ground!





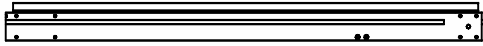
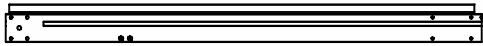
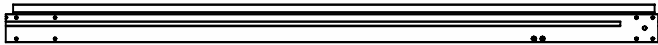
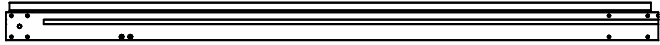
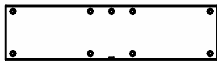
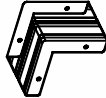

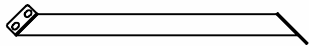
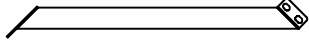
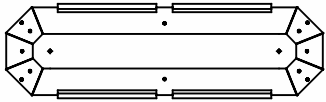
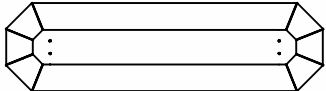

It is important during assembly to closely follow the instructions, complete the assembly on a solid level surface and that you follow the instruction to square up, level and anchor the structure, this will reduce the gap at wood connections during assembly.

If you dispose of Aoodor structure: Please disassemble and dispose of your unit so that it does not create any unreasonable hazards at the time it is discarded. Be sure to follow your local waste ordinances.

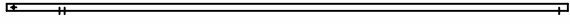
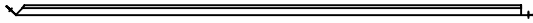

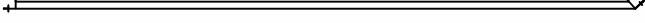
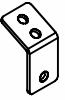



Parts Identification (Metal Parts)

Parts	Desc	QTY	Ref No
A		4	800-192-001
B		2	800-192-002
C		2	800-192-003
D		2	800-192-004
E		2	800-192-005
F		4	800-192-006
G		4	800-192-007
H		4	800-192-008
J1		4	800-192-009
J2		4	800-192-010
K		1	800-192-011
K1		1	800-192-012

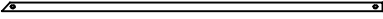
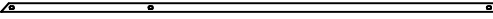

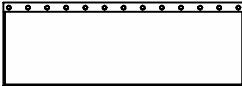
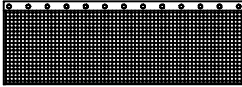
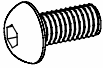
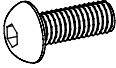

Parts Identification (Metal Parts)

Parts	Desc	QTY	Ref No
L		4	800-192-013
M		4	800-192-014
N		4	800-192-015
P1		2	800-192-016
P2		2	800-192-017
P3		2	800-192-018
P4		2	800-192-019
Q		4	800-192-020
R1		4	800-192-021
R2		4	800-192-022
S		12	800-192-023

Parts Identification (Metal Parts)

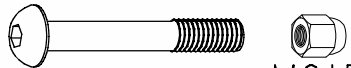
Parts	Desc	QTY	Ref No
T1		4	800-192-024
T2		4	800-192-025
U1		4	800-192-026
U2		4	800-192-027
X		4	800-192-028
X1		4	800-192-029
1	 M6*16	162+2	800-192-030
2	 M6*25	8	800-192-031
3		88	800-192-032
4		4	800-192-033
5		40	800-192-034

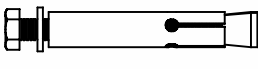
Parts Identification (Metal Parts)

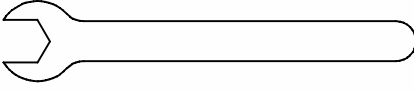
Parts	Desc	QTY	Ref No
6	 M6*50	4	800-192-035
7		12	800-192-036
8	 M6*60	8	800-192-037
		1+1	
		1	

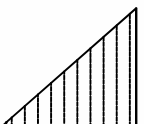
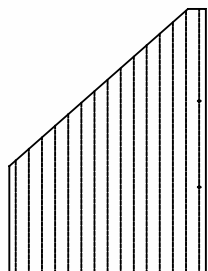
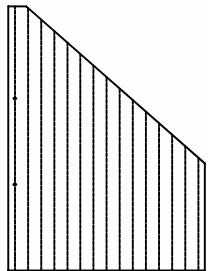
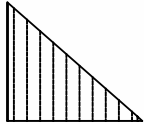
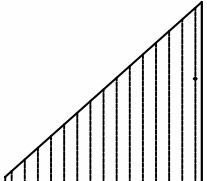
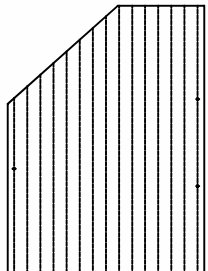
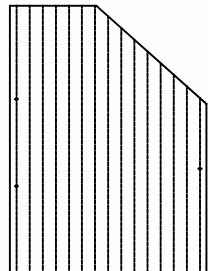
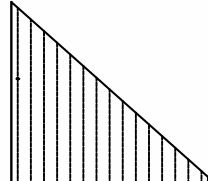
Parts	V1	V2	V3	V4
Desc				
Qty	2	2	2	2
Ref No	800-192-038	800-192-039	800-192-040	800-192-041
Parts	W1	W2	W3	W4
Desc				
Qty	2	2	2	2
Ref No	800-192-042	800-192-043	800-192-044	800-192-045

Assembly

1



A (X4)



L (X4)

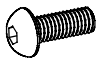

1# (X12)

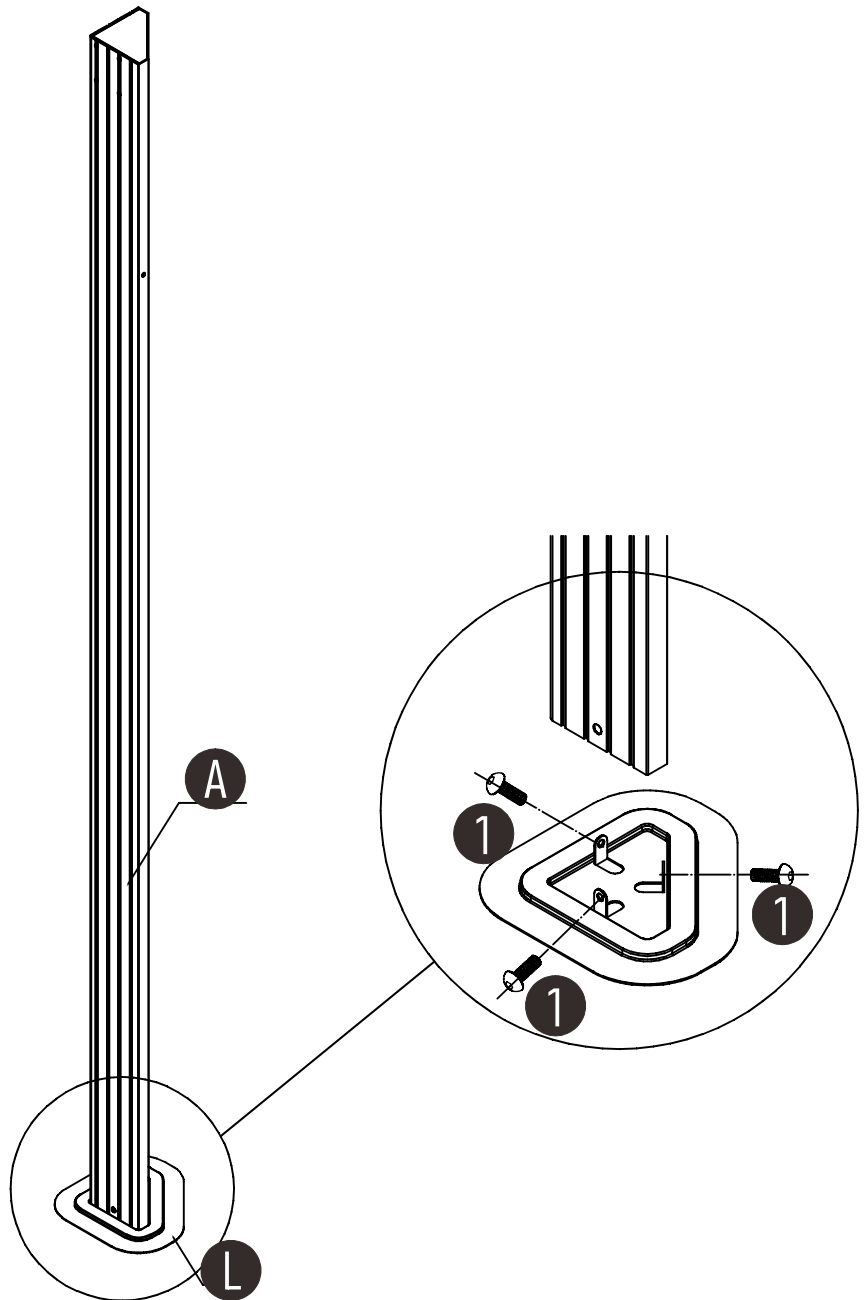

Assembly

2



B (X2)

D (X2)

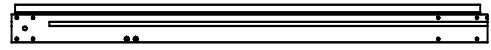
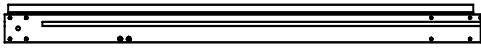

C (X2)

E (X2)

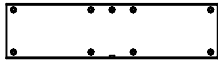

F (X4)

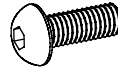

1# (X32)



3# (X88)

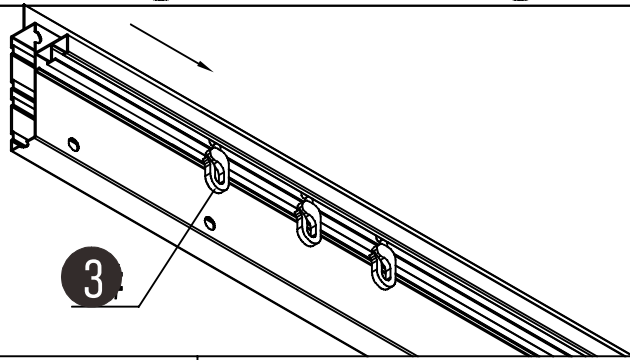

3

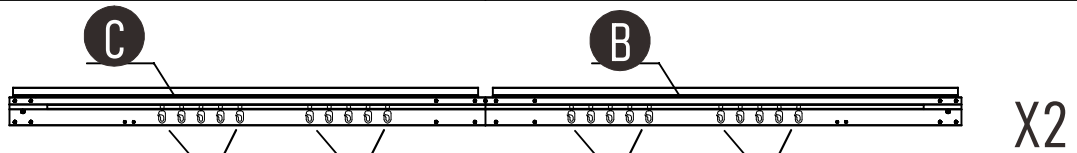
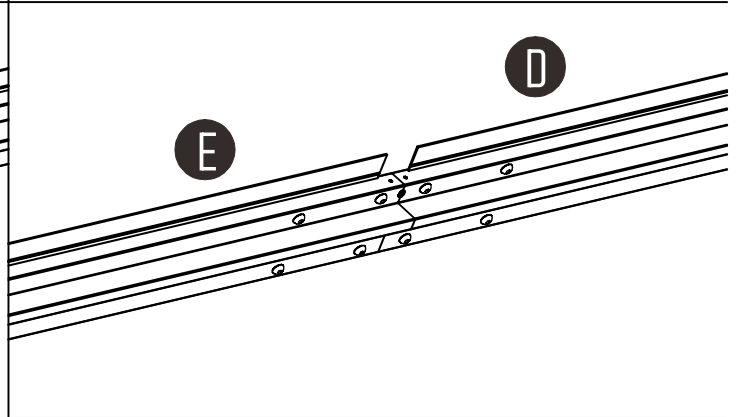
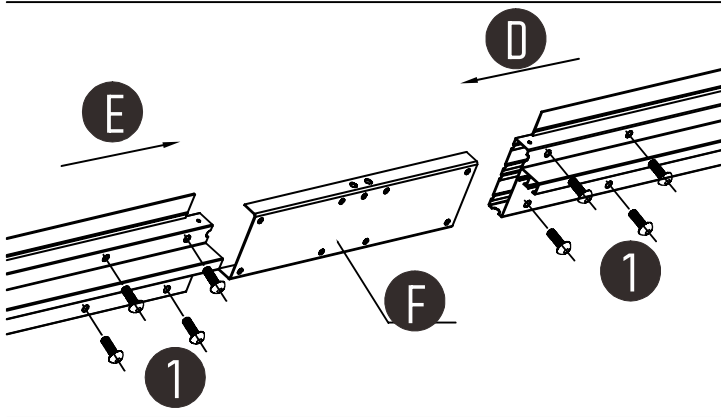
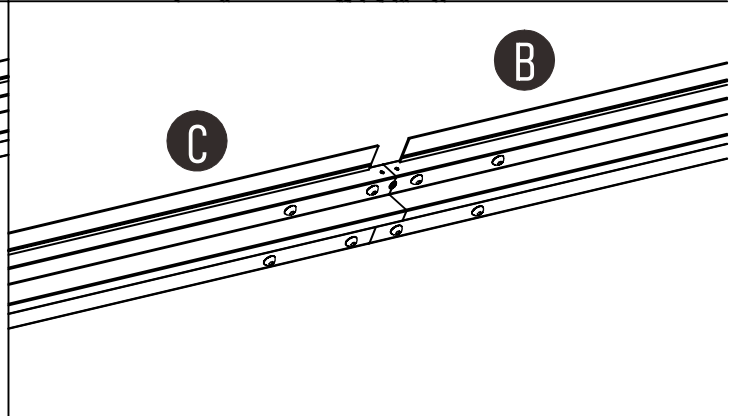
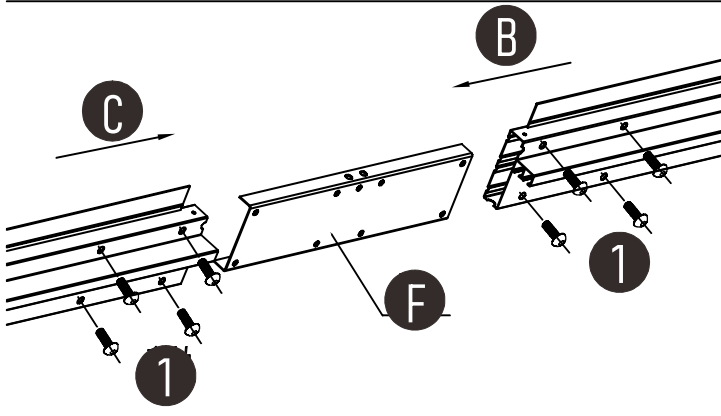

X2

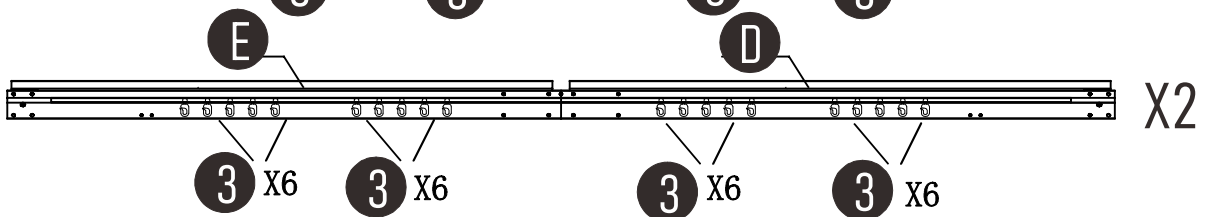

X2

Assembly

4

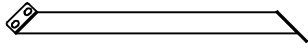

J1 (X4)

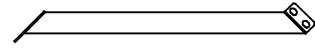

J2 (X4)

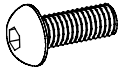

1# (X24)

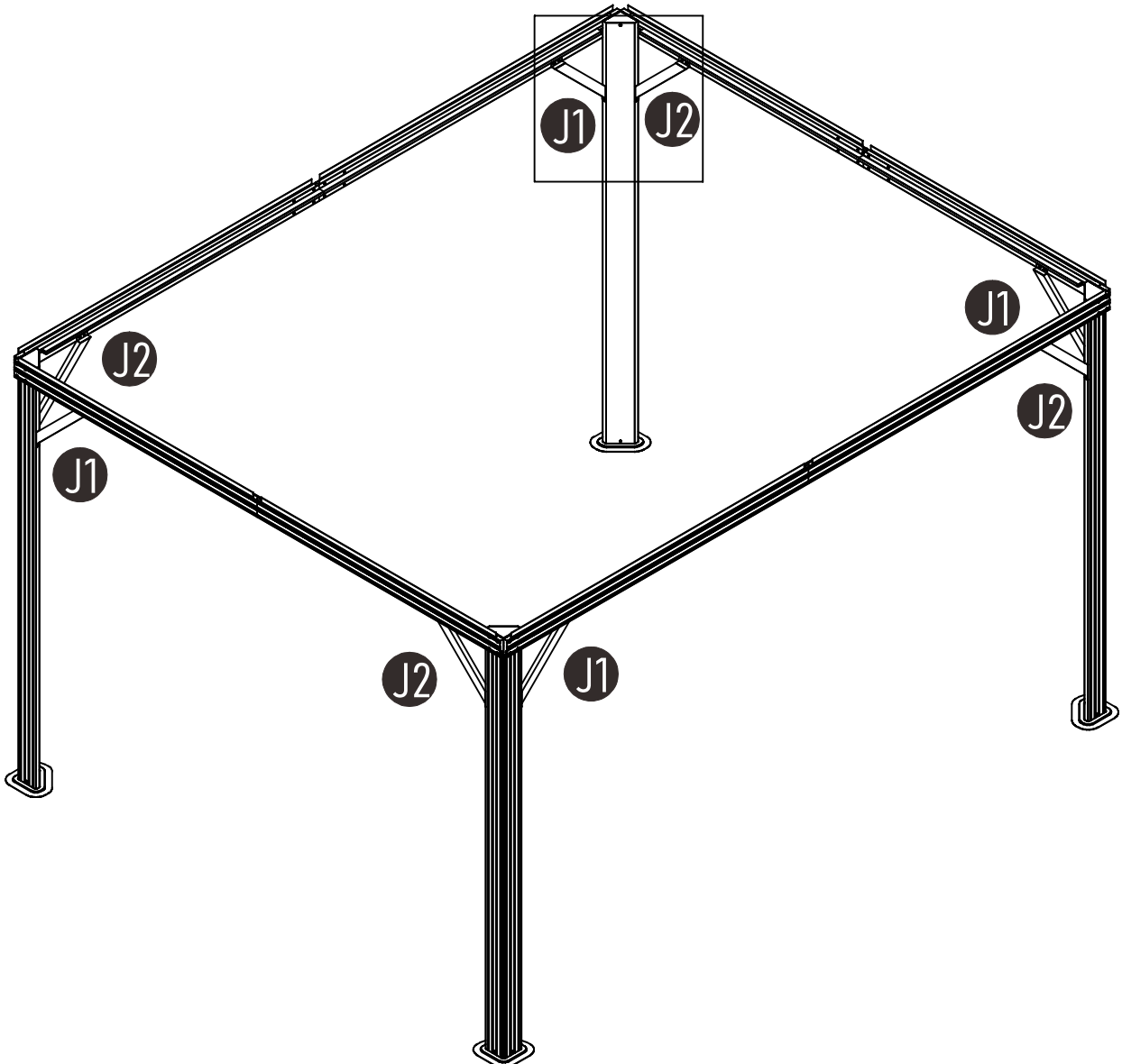
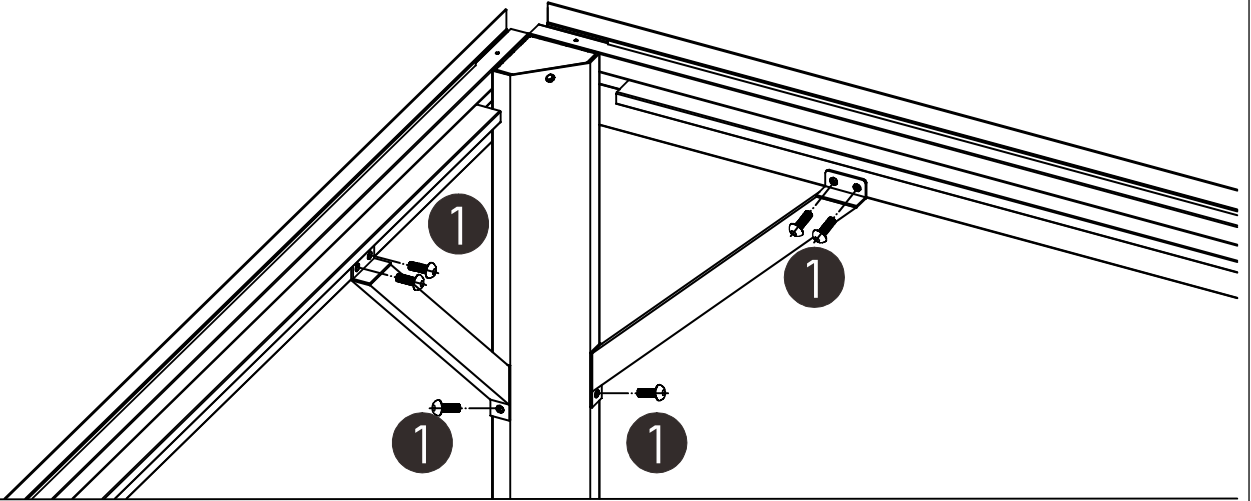

Assembly

5



G (X4)



H (X4)



4# (X4)



5# (X24)

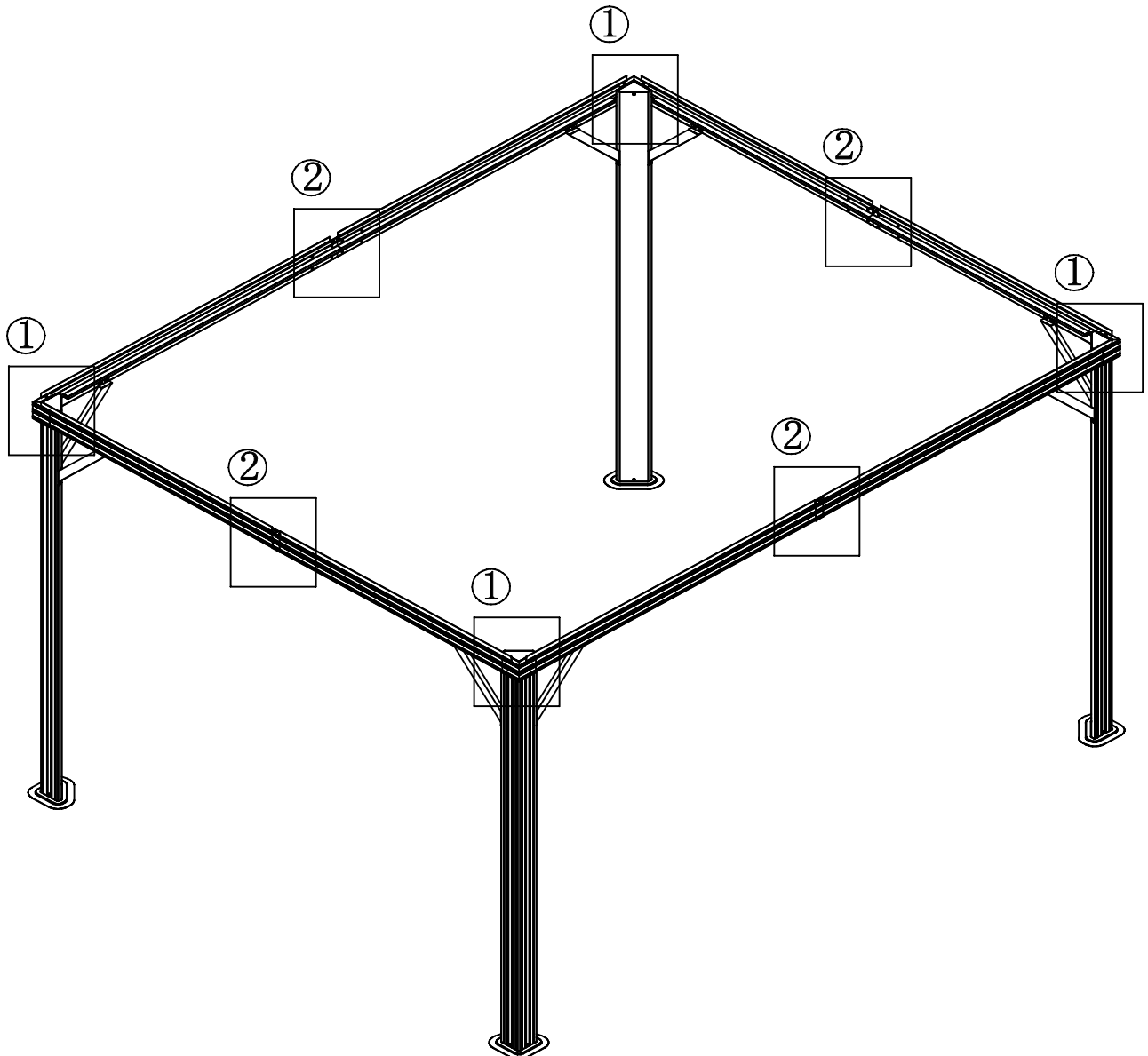
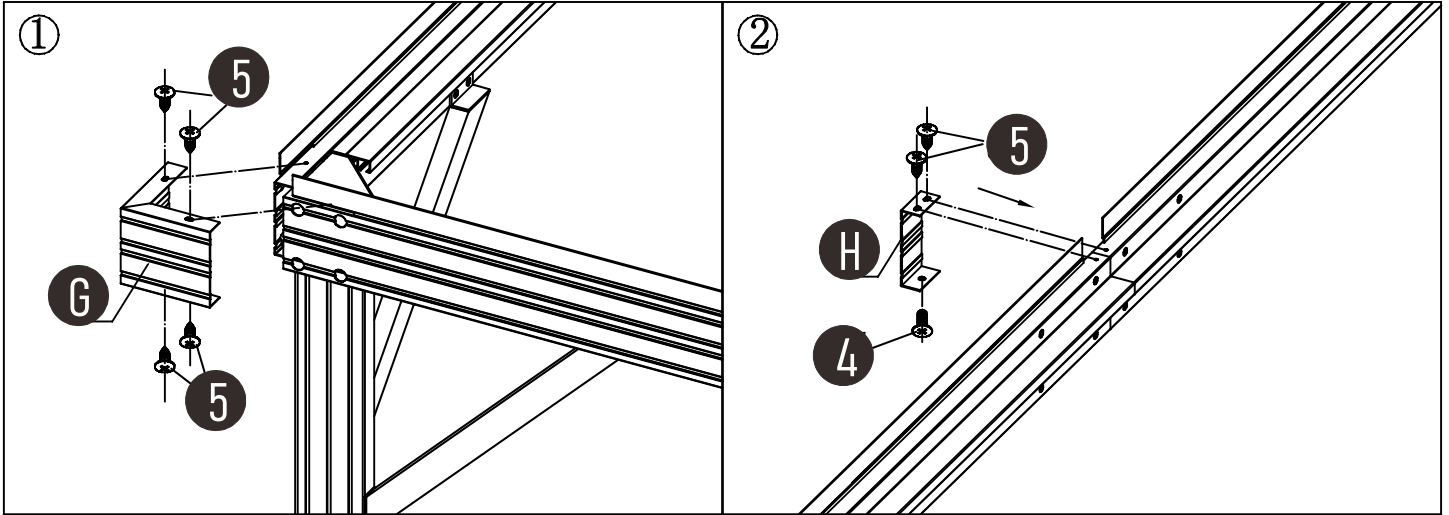

Assembly

6

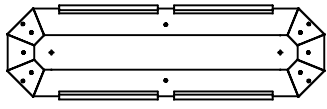

K (X1)

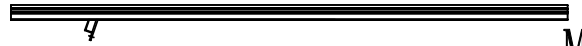

M (X4)

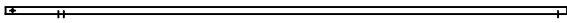

N (X4)



Q (X4)

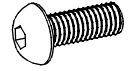

1# (X28)

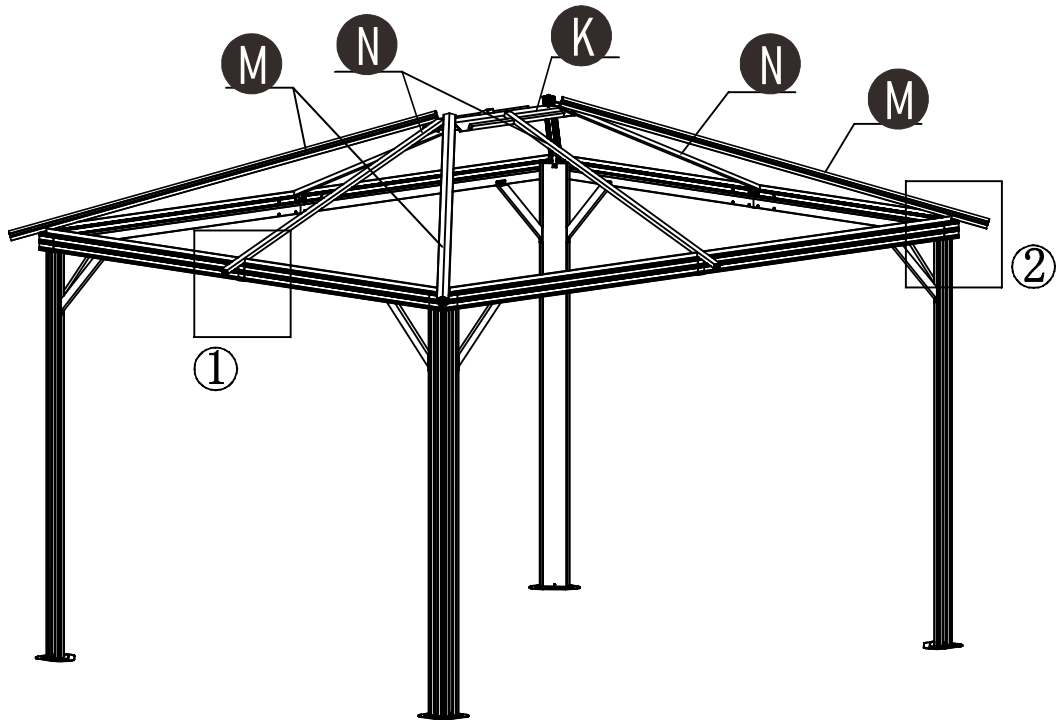
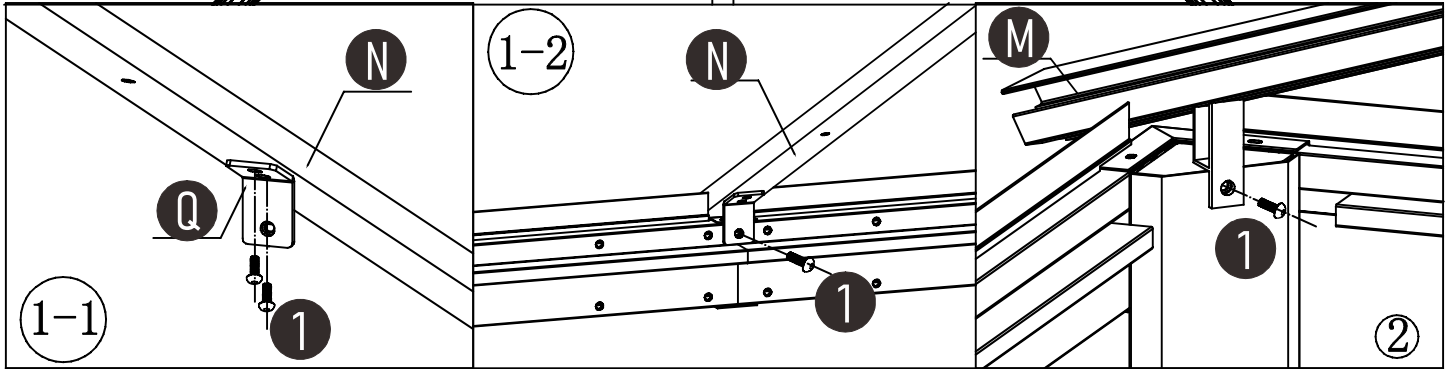
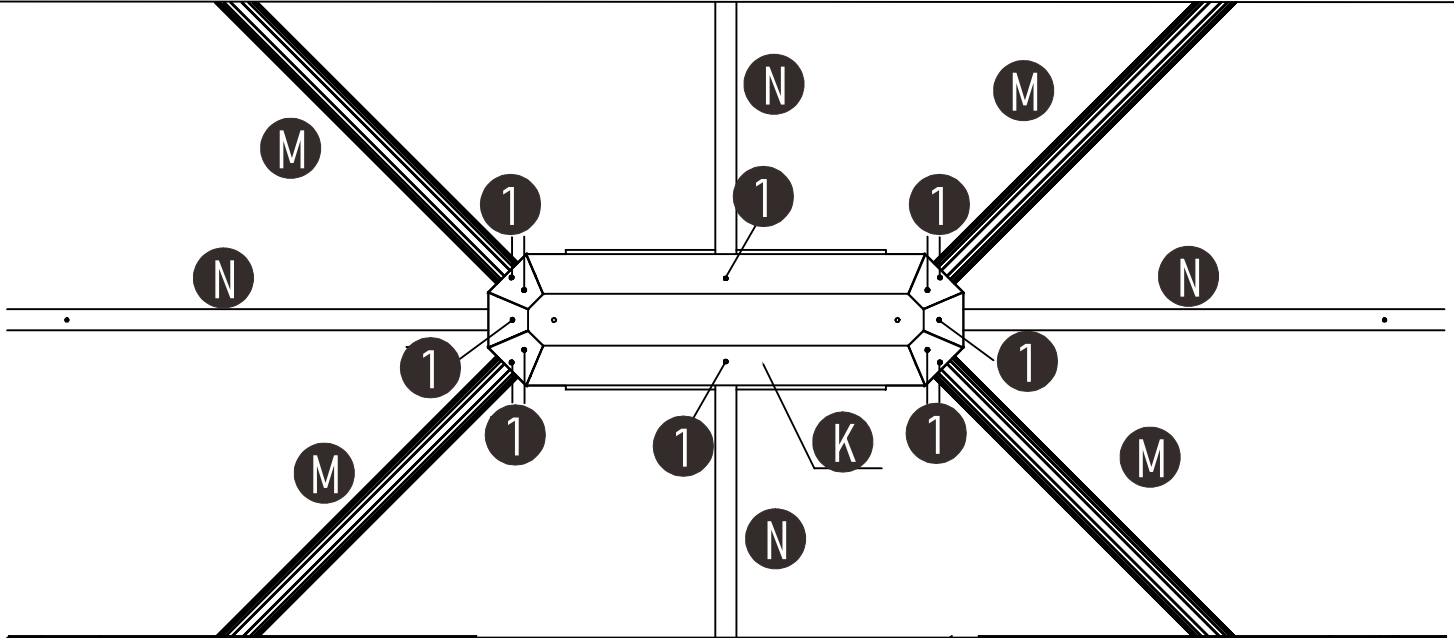

7

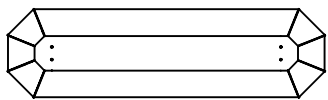

K1 (X1)

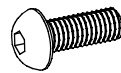

1# (X2)

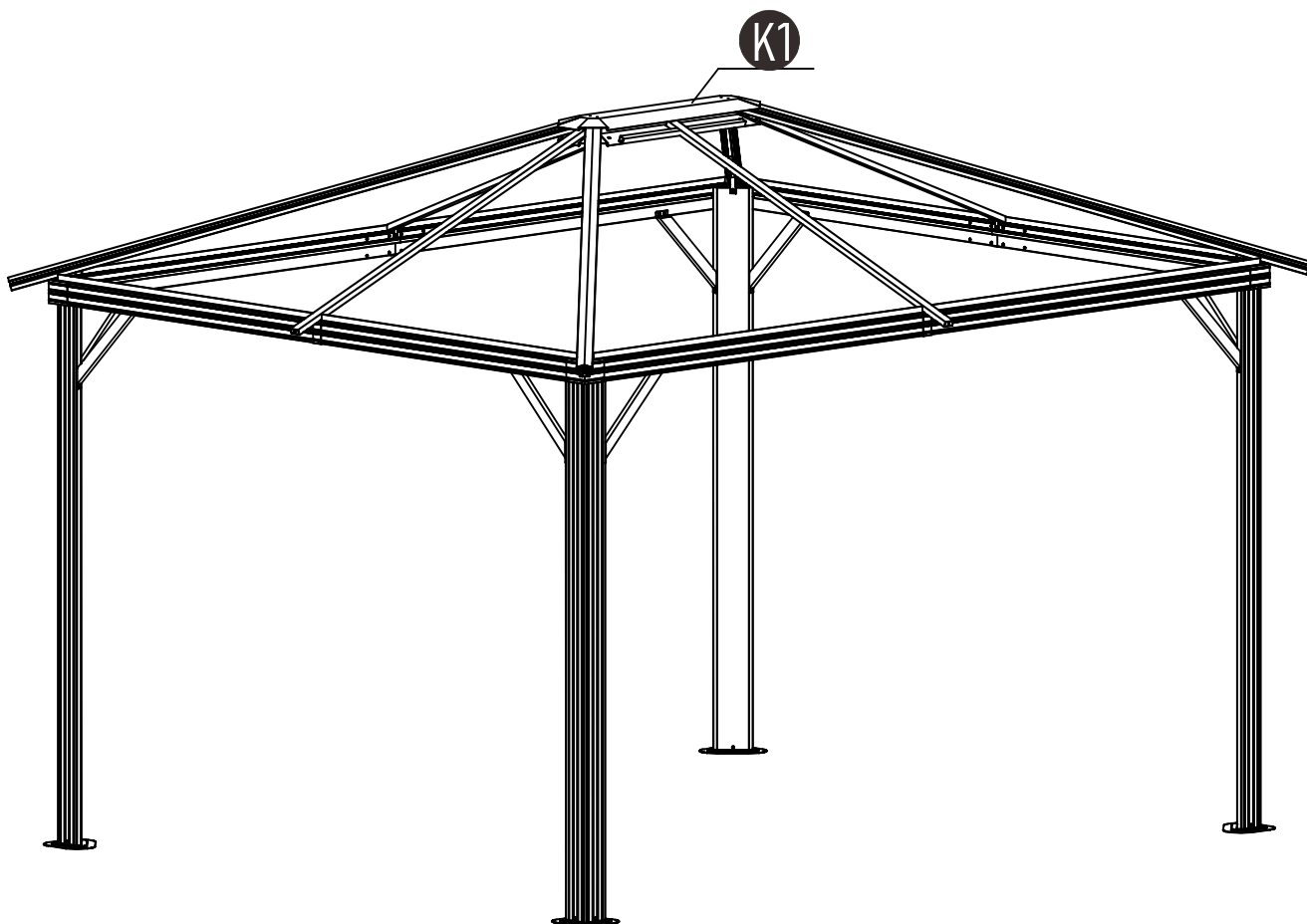
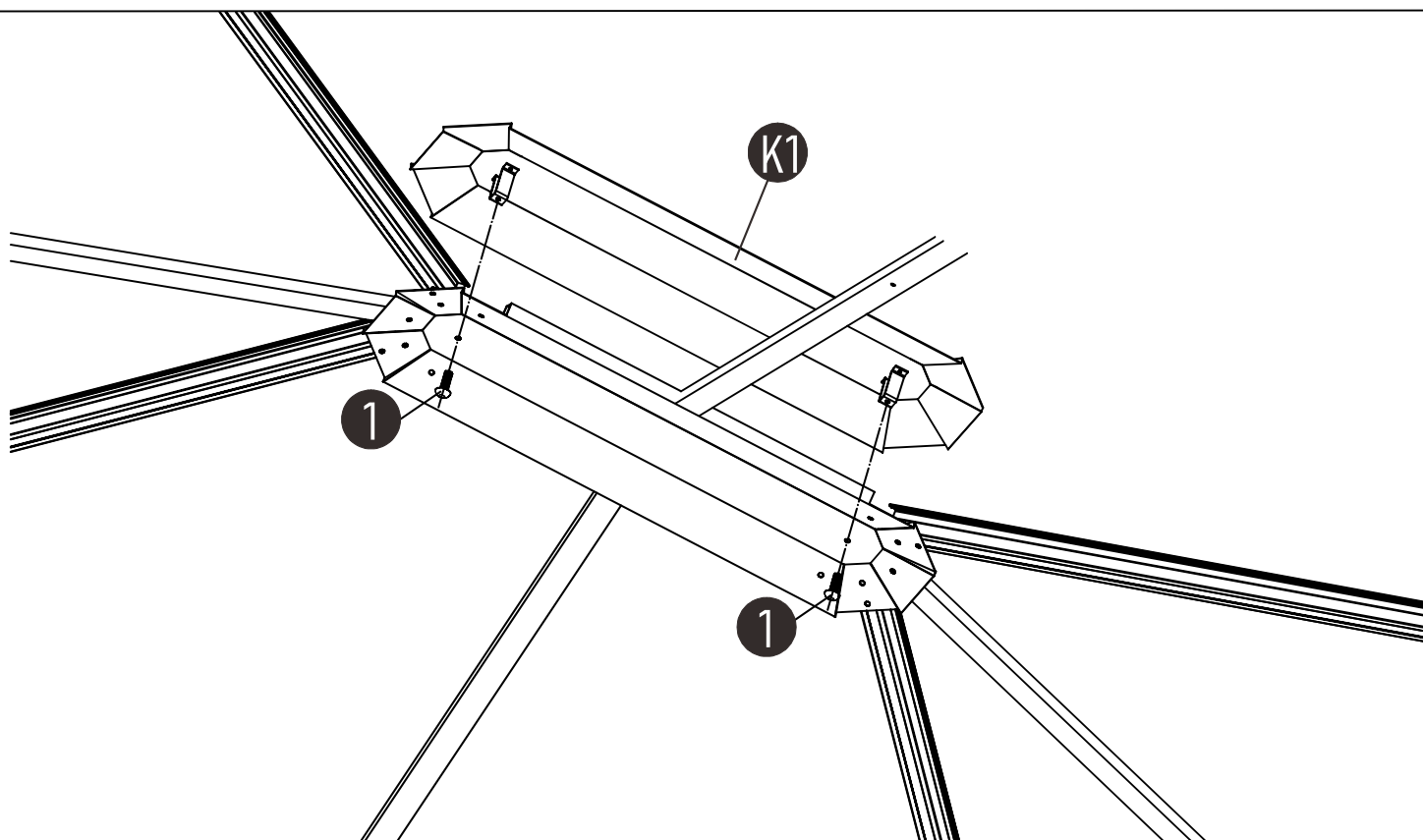

Assembly

8

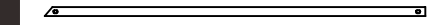

T1 (X4)



U1 (X4)

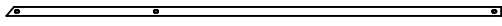

T2 (X4)



U2 (X4)

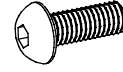

1# (X24)

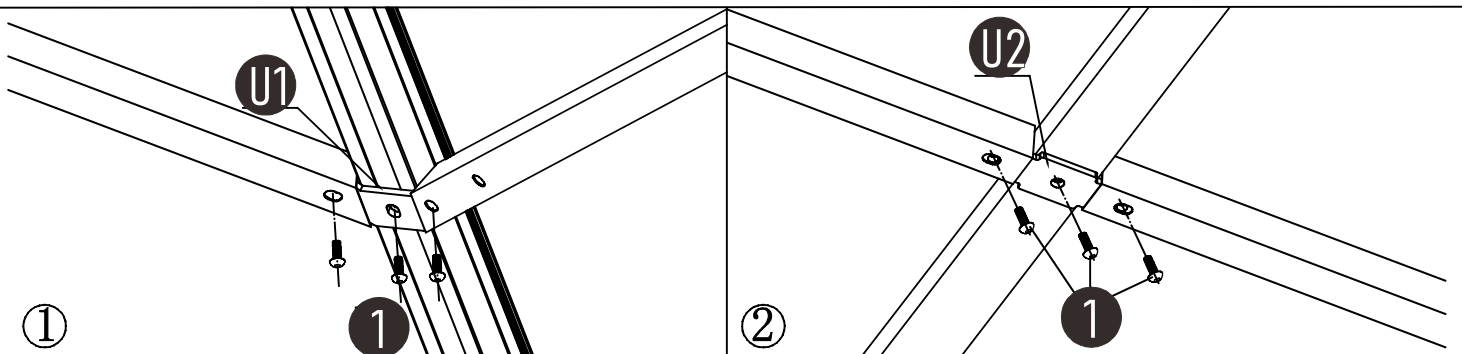
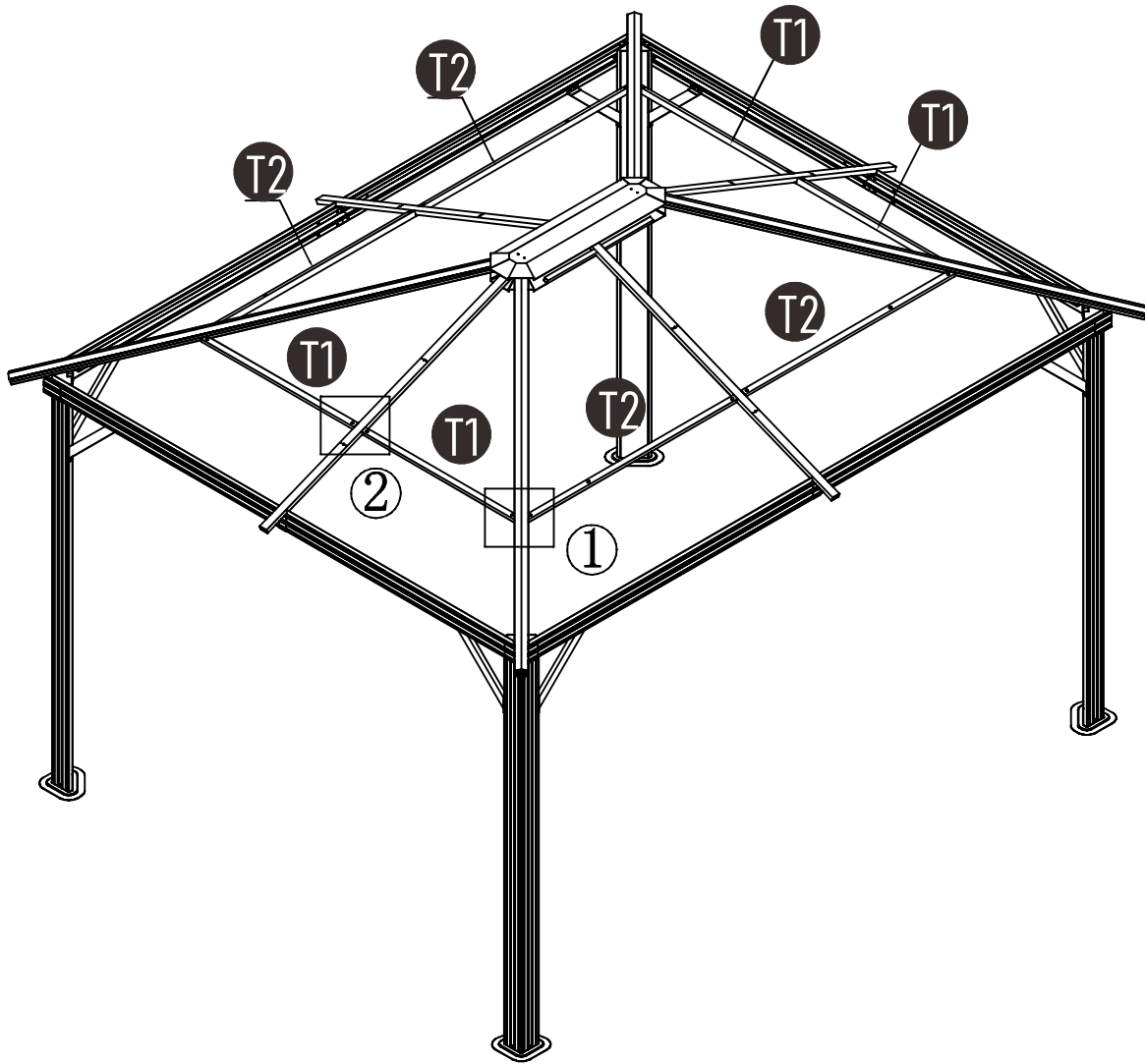

9

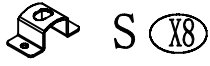

5# X16

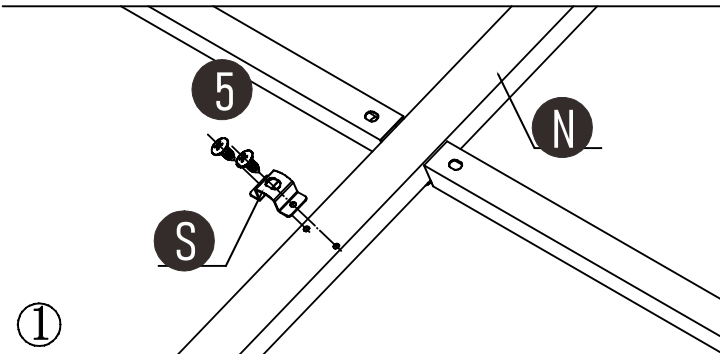
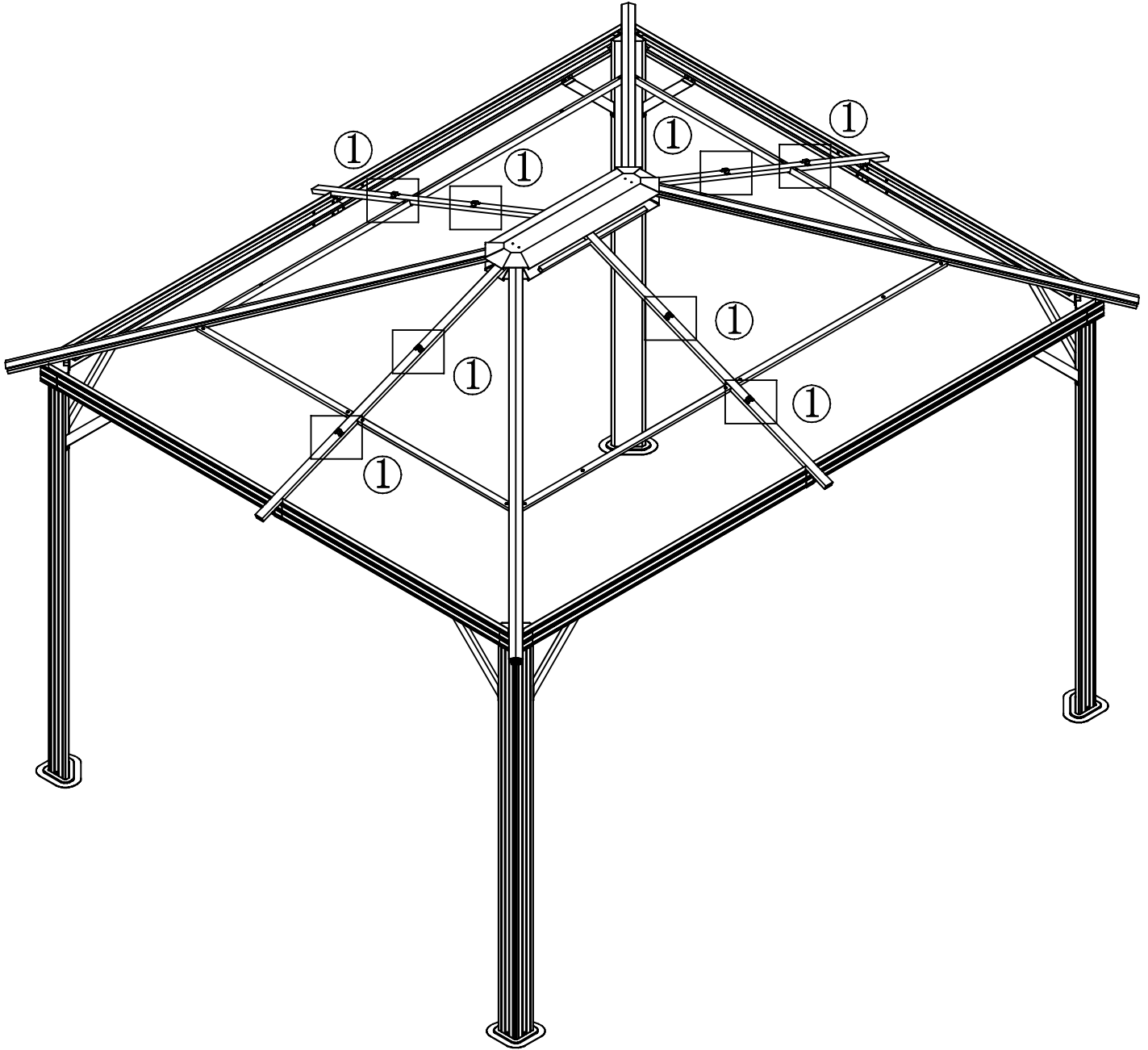

10

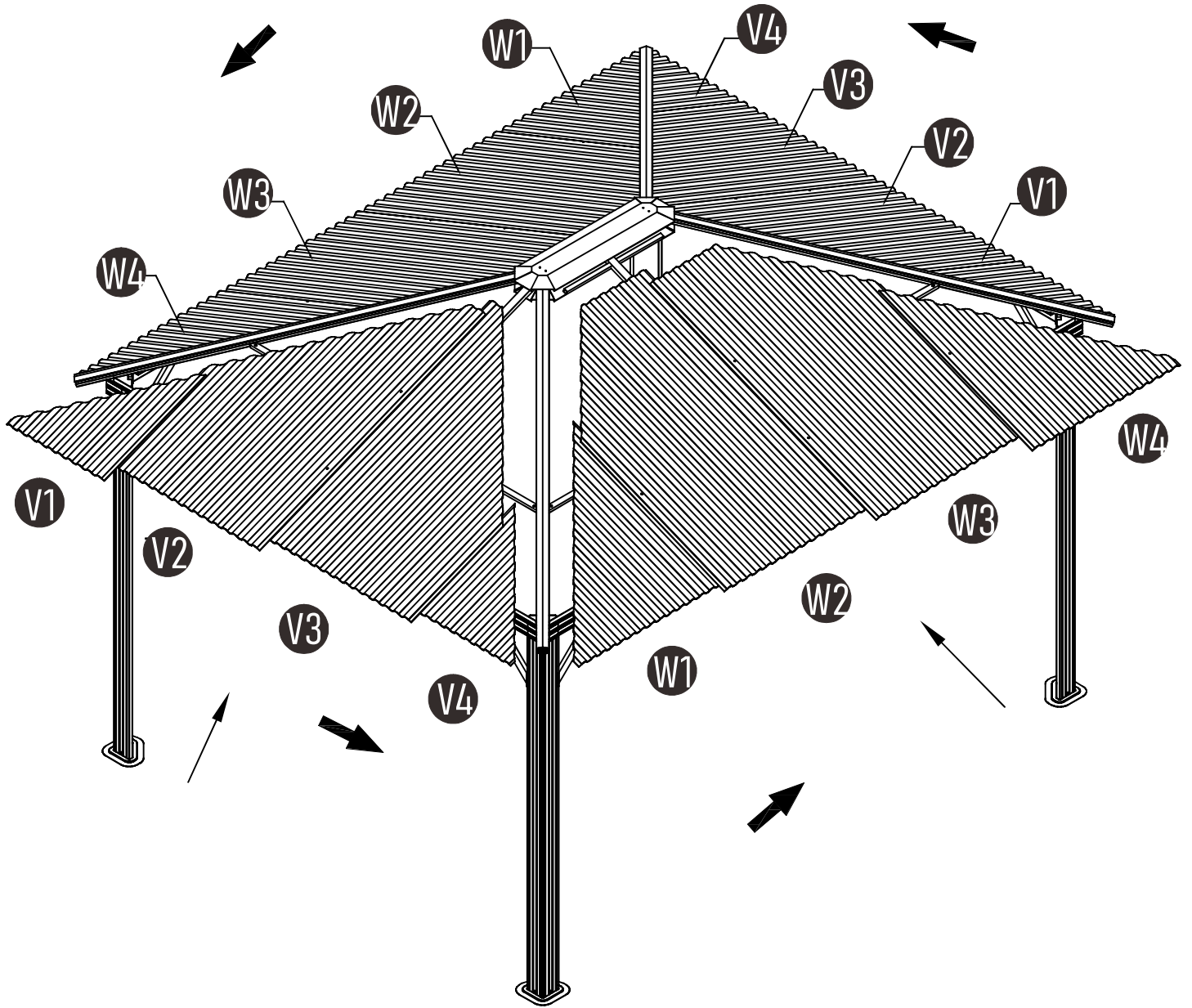

Assembly

11



S (X4)

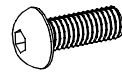

2# (X8)

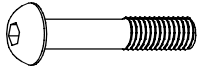

6# (X4)



7# (X12)

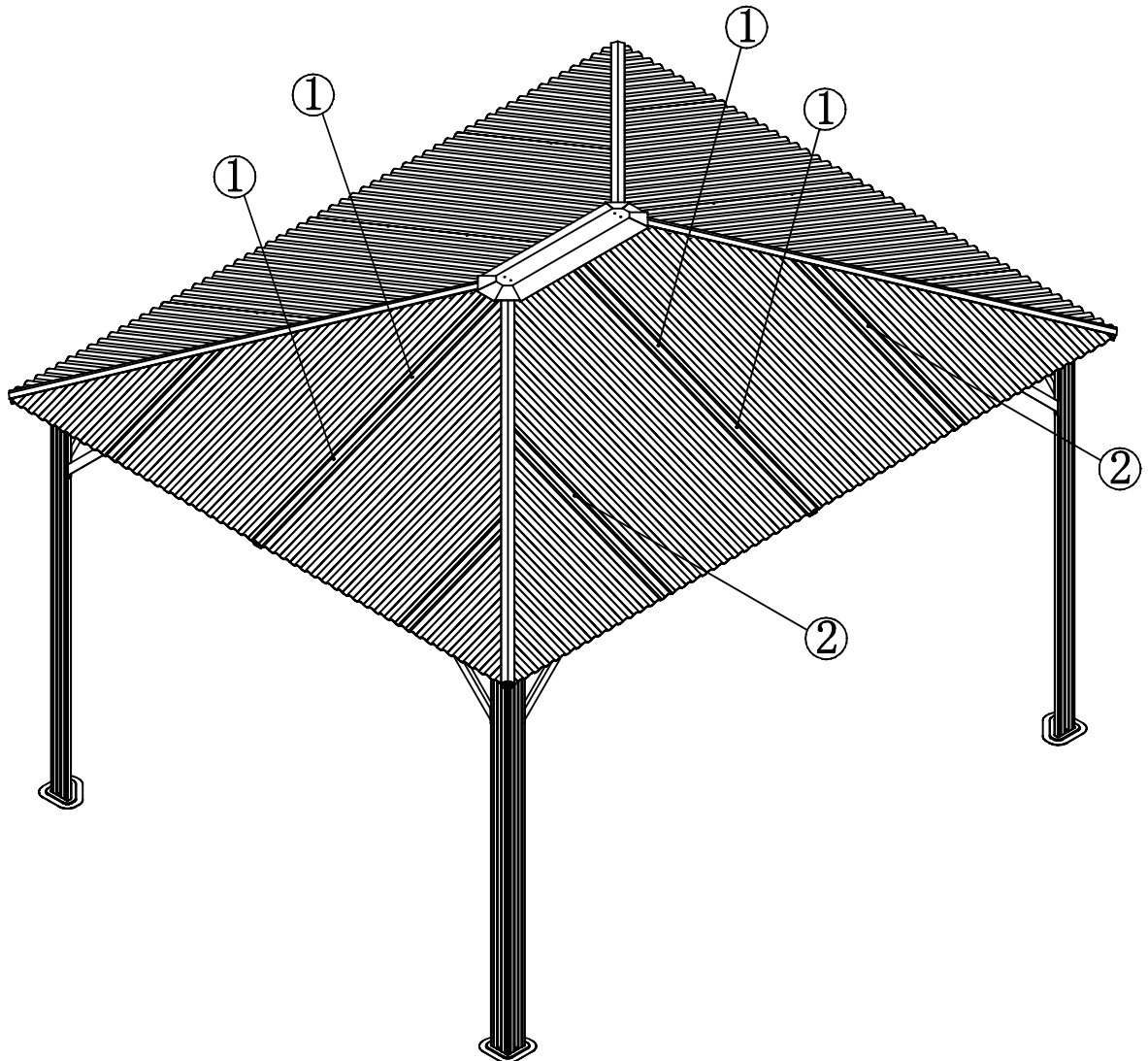
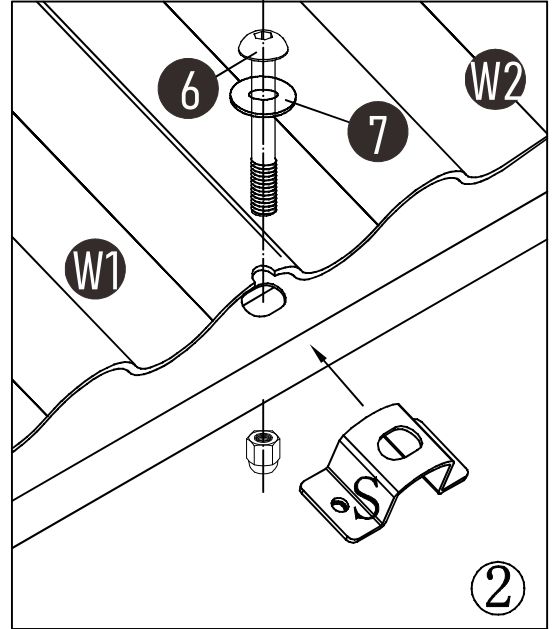
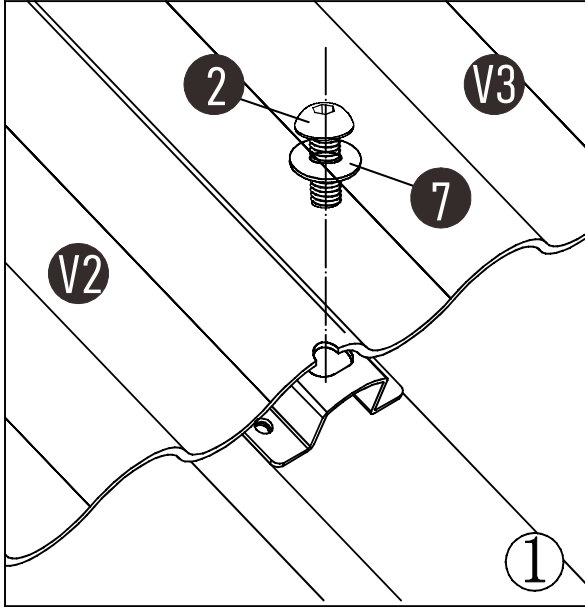

12

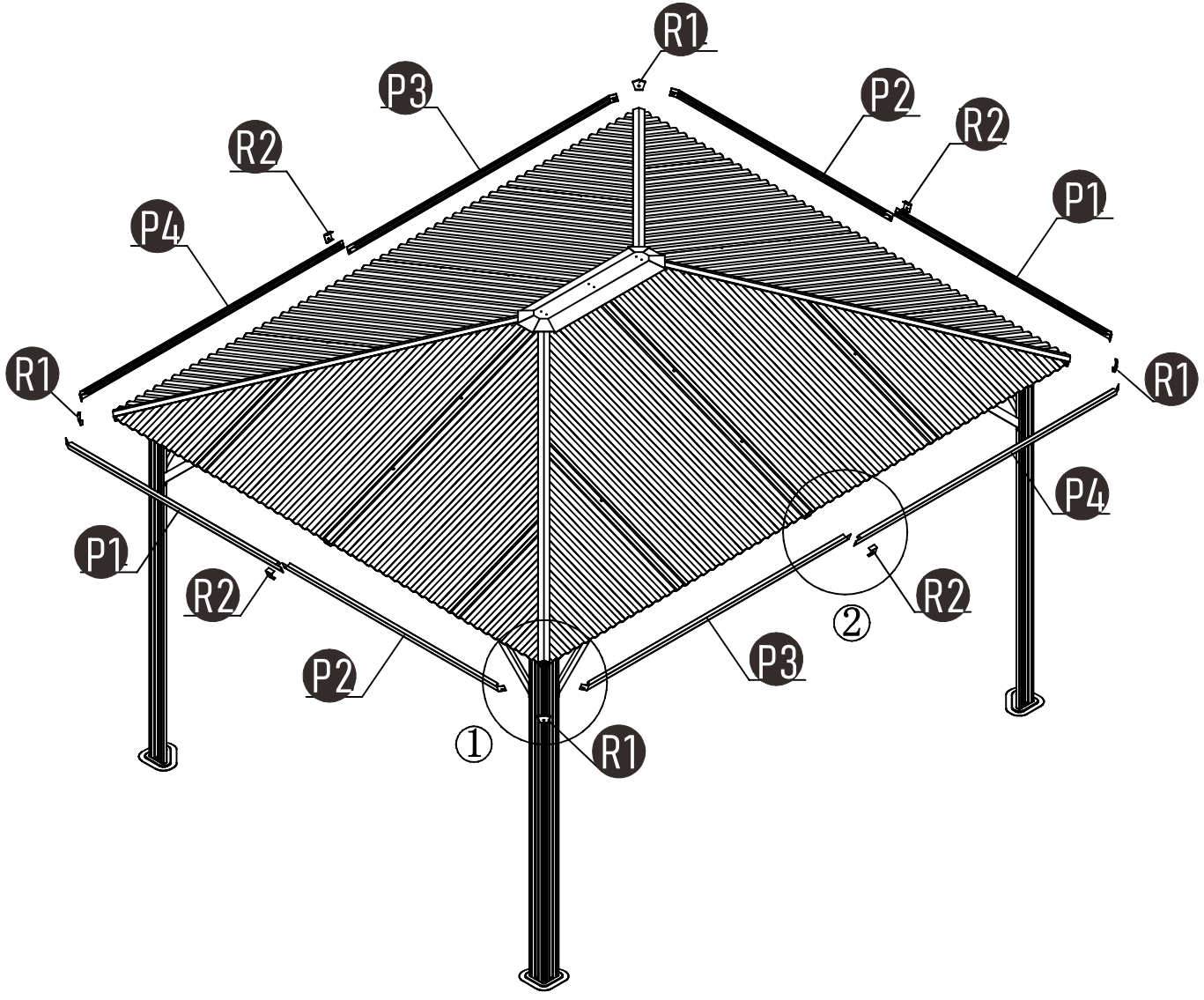
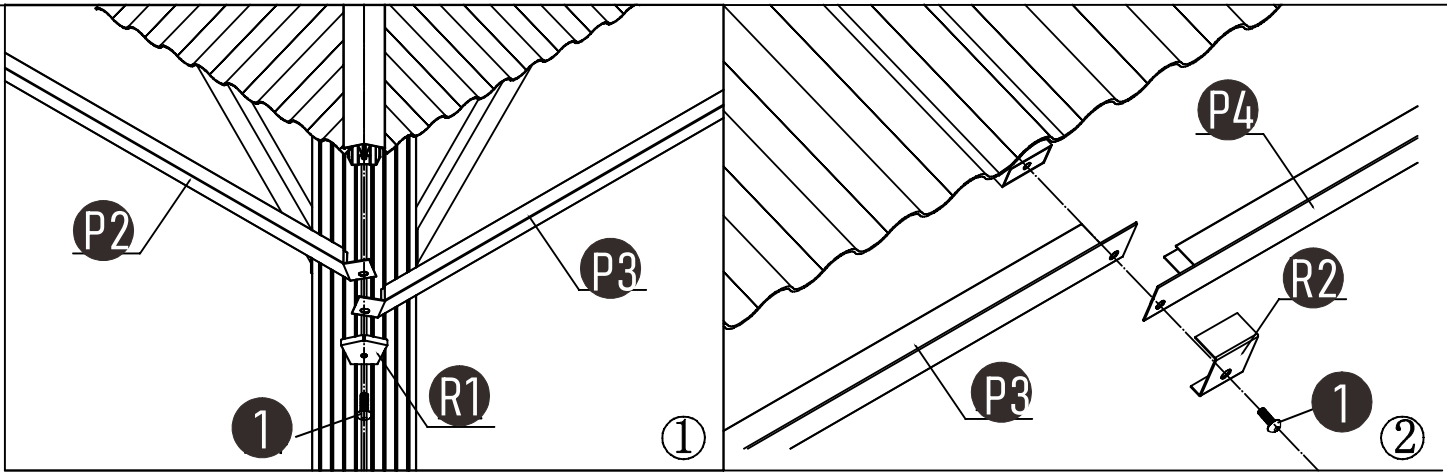
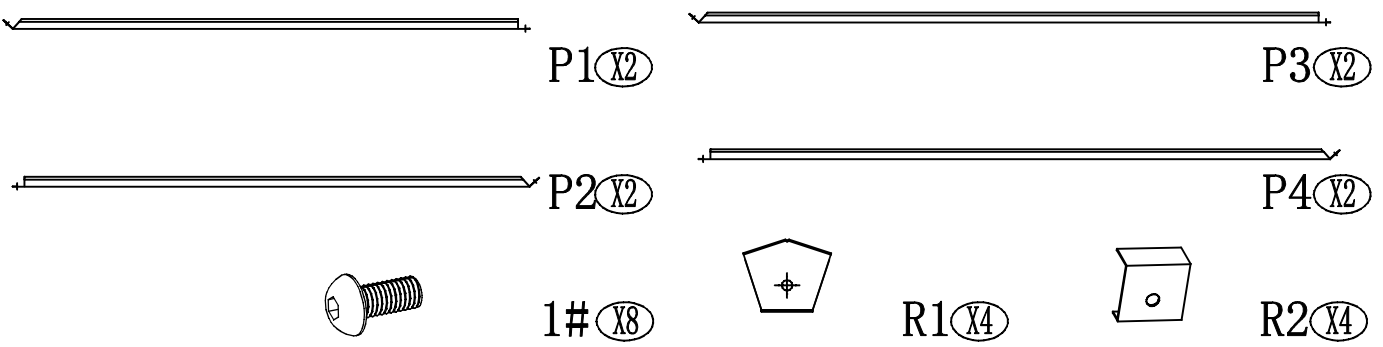

13

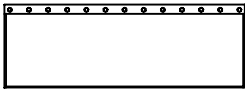

X (X4)

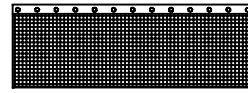

X1 (X4)

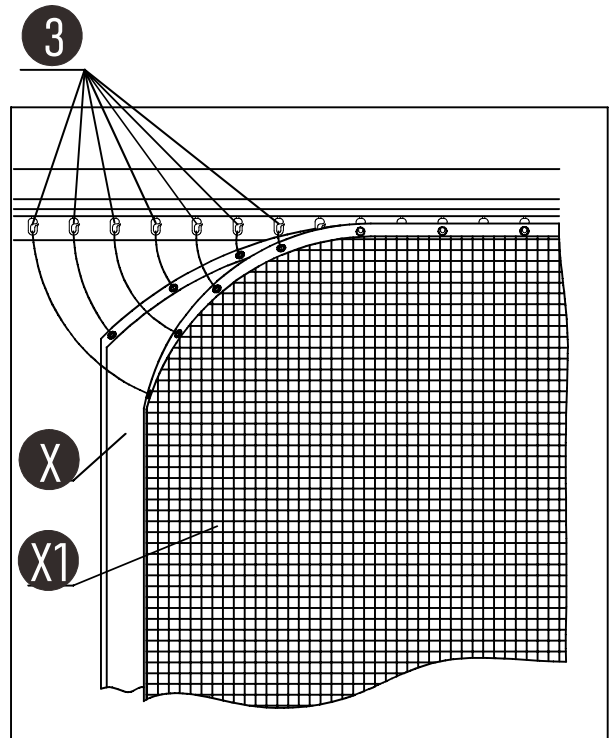
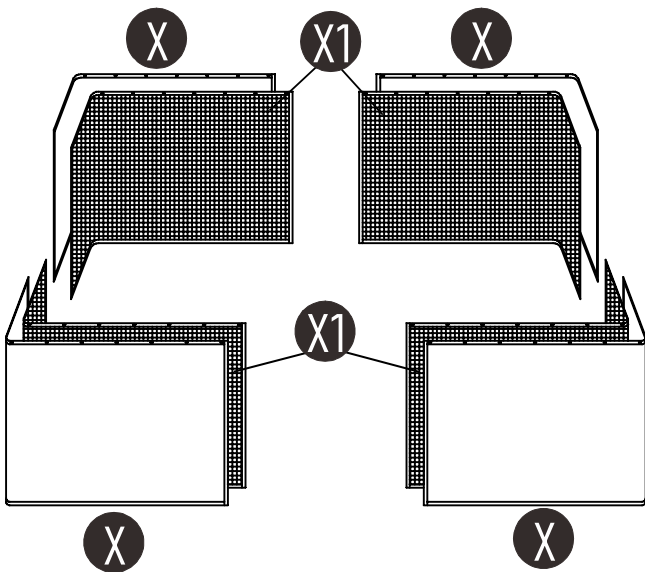
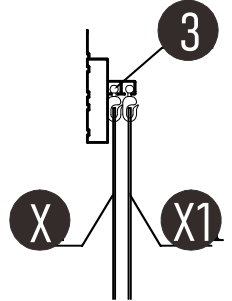
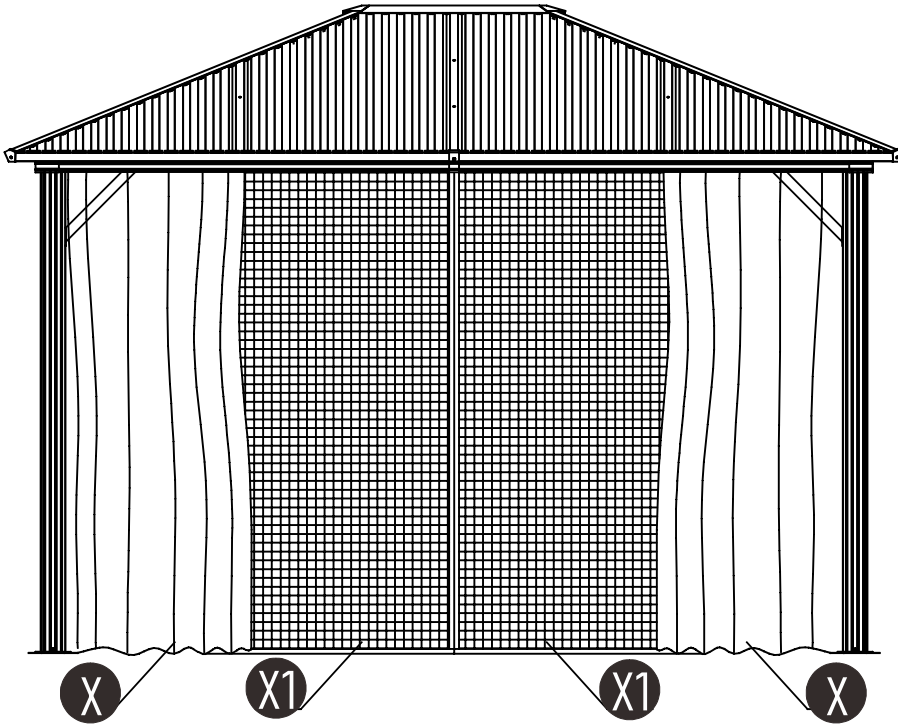

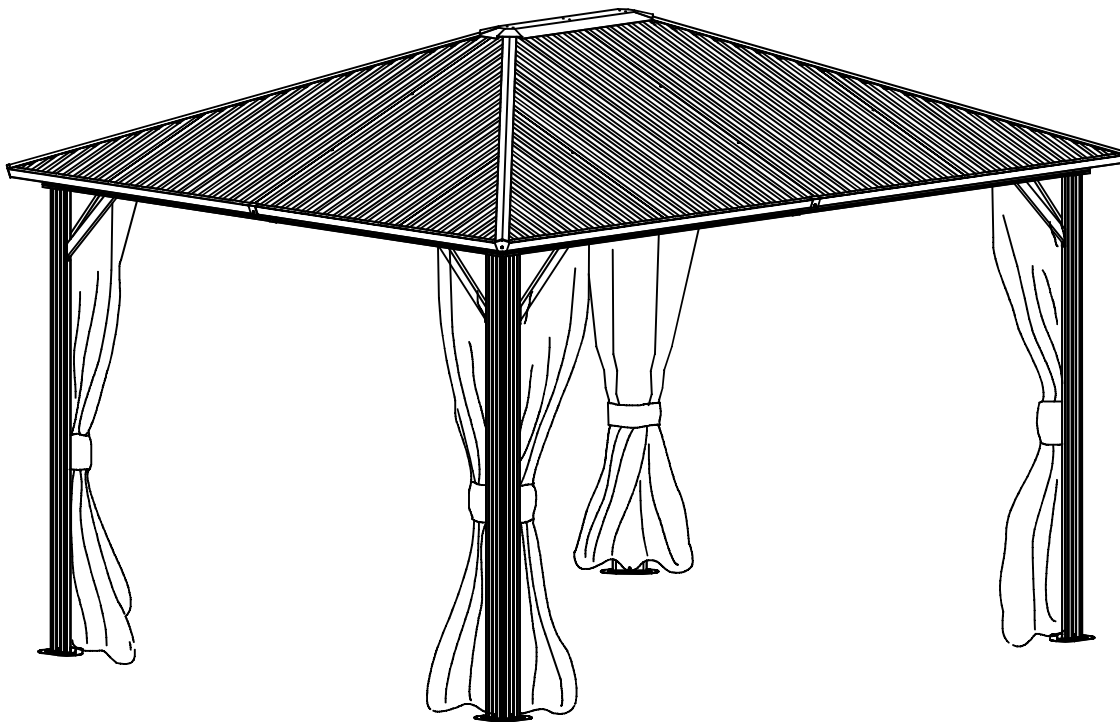
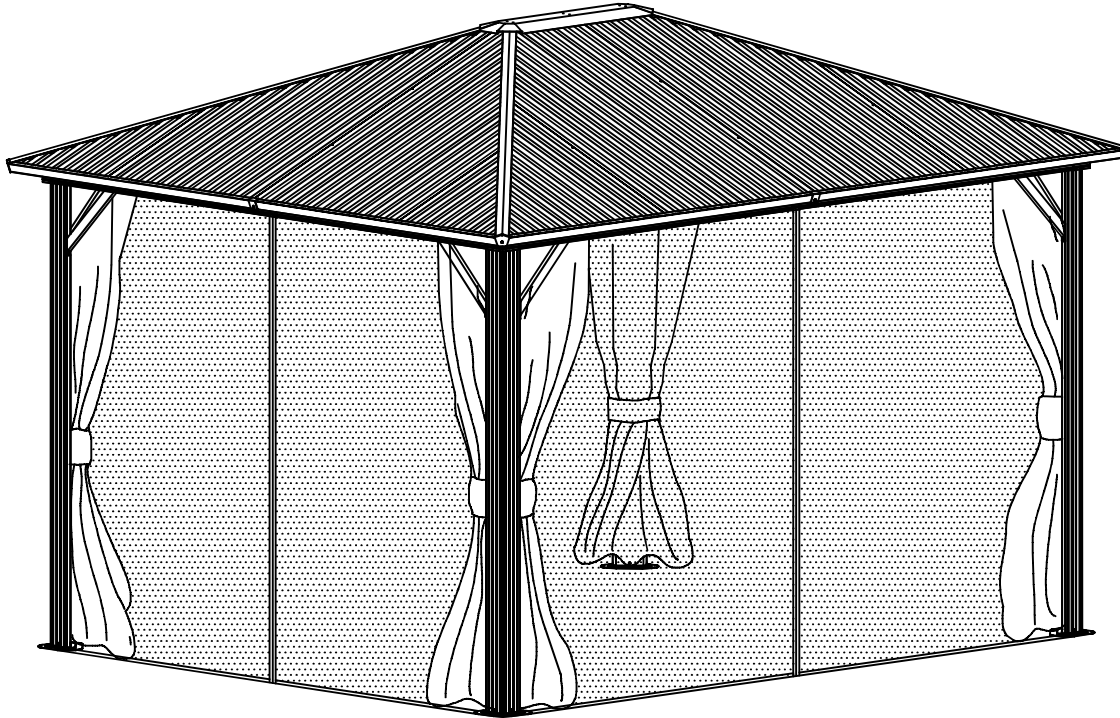

Please don't hesitate to contact us for any further questions,
your satisfaction is guaranteed.
customerservice@aodor.com
<https://www.aodor.com/>