

**EN\_IMPORTANT, RETAIN FOR FUTURE REFERENCE: READ CAREFULLY.**

**FR\_IMPORTANT: A LIRE ATTENTIVEMENT ET À CONSERVER POUR CONSULTATION  
ULTÉRIEURE.**

**ES\_IMPORTANTE, LEA Y GUARDE PARA FUTURAS REFERENCIAS.**

**PT\_IMPORTANTE, RETER PARA REFERÊNCIA FUTURA: LEIA ATENTAMENTE.**

**DE\_WICHTIG! SORFGFÄLTIG LESEN UND FÜR SPÄTERES NACHSCHLAGEN AUFBEWAHREN.**

**IT\_IMPORTANTE! CONSERVARE IL PRESENTE MANUALE PER FUTURO RIFERIMENTO E  
LEggerlo ATTENTAMENTE.**

**PARTS**

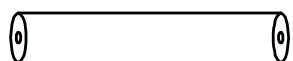

**A** x 1

480mm

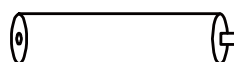

**B** x 1

350mm

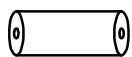

**C** x 1

250mm

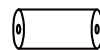

**D** x 1

215mm

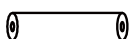

**E** x 3

250mm

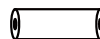

**F** x 3

160mm

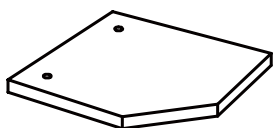

**G** x 1

500mm\*400mm

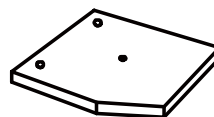

**H** x 1

350mm\*300mm

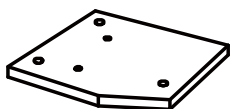

**I** x 1

350mm\*300mm

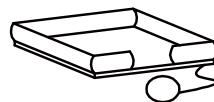

**J** x 1

300mm\*300mm

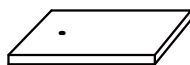

**K** x 1

250mm\*250mm



**L** x 1

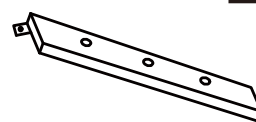

**M** x 2

**HARDWARE**



**N** x17  
+1(spare)

M8\*40



**O** x 1

M8\*80

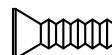

**P** x 2

M8\*15



**Q** x 1

01

**H** x 1

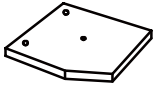

**N** x 6



**I** x 1



**Q** x 1

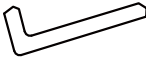

**E** x 3

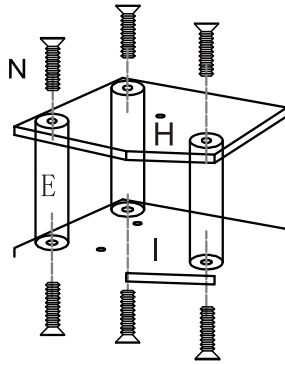
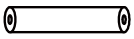

+

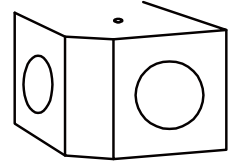
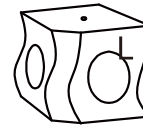

**L** x 1



02

**G** x 1

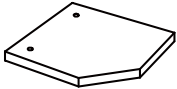

**D** x 1



**K** x 1

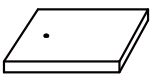

**N** x 4



**A** x 1

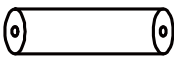

**O** x 1



**C** x 1

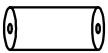

**Q** x 1

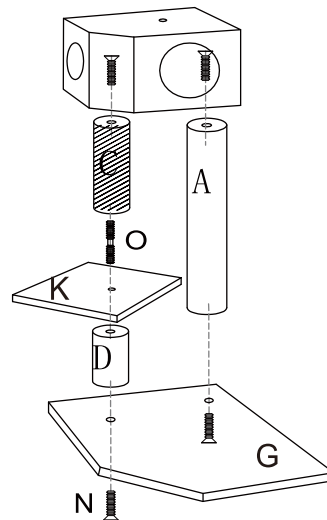

03

**J** x 1

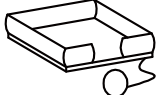

**N** x 7



**M** x 2

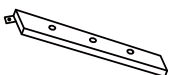

**P** x 2



**B** x 1

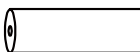

**Q** x 1



**F** x 3

