

# Hope & Living Furniture

ZX-970 Double

Assembly instructions















CONGRATULATIONS ON YOUR NEW BED PURCHASE













~Warning: do not move bed after final assembly as it may result in damages to floor and/or bed.~

# Hope & Living Furniture

## ZX-970 Double Assembly instructions

Hardware included in carton.

| A1   | A   | B   | C   | D   | E   | H   | M   | R   | Z   | I  | I2  | F   | F2  | F3  |
|--|---|---|---|---|---|---|---|---|---|--|---|---|---|---|
|  |  |  |  |  |  |  |  |  |  |  |  |  |  |  |
| φ8MM   | φ8*30MM   | φ8*50MM   | φ8*40MM   | φ6MM  | φ8MM  | φ8*20MM   | φ6*50MM   | φ7*35MM   | φ8MM  | φ8MM   |   | H=20CM  |   |   |
| 8PCS   | 6PCS  | 2PCS  | 30PCS   | 2PC   | 58PCS   | 12PCS   | 2PC   | 2PCS  | 10PCS   | 1PC  | 1PC   | 2PCS  | 2PCS  | 2PCS  |

| J   | J1  | K   | N   | O   | P   | S   | T   | T1  | U   | U1   | Y   |
|---|---|---|---|---|---|---|---|---|---|--|---|
|  |  |  |  |  |  |  |  |  |  |  |  |
| H=29CM  | H=32CM  |   |   |   |   |   |   |   |   |  |   |
| 1PCS  | 1PCS  | 2PCS  | 12PCS   | 2PCS  | 4PCS  | 1PC   | 1PC   | 4PC   | 2PCS  | 2PCS   | 1PC   |

①

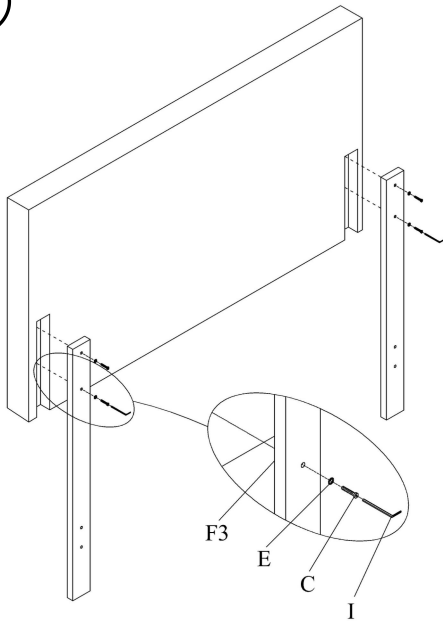

②

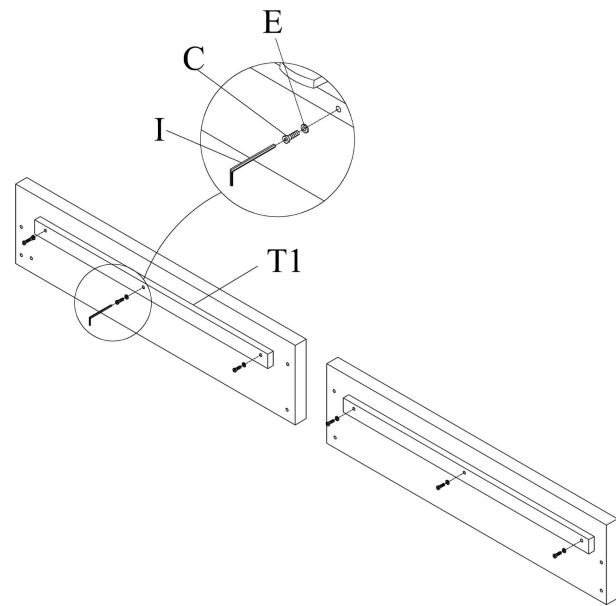

### Step#1

Attach Metal leg (F3) to Headboard from carton using Bolt (C), Washer (E) by Wrench (I) fasten .

### Step#2

Attach Wooden strip (T1) to Bed-Rail, using Washer (E), Bolt (C) by Wrench (I) fasten.















CONGRATULATIONS ON YOUR NEW BED PURCHASE













~Warning: do not move bed after final assembly as it may result in damages to floor and/or bed.~

# Hope & Living Furniture

## ZX-970 Double Assembly instructions

Hardware included in carton.

| A1   | A   | B   | C   | D   | E   | H   | M   | R   | Z   | I  | I2  | F   | F2  | F3  |
|--|---|---|---|---|---|---|---|---|---|--|---|---|---|---|
|  |  |  |  |  |  |  |  |  |  |  |  |  |  |  |
| φ8MM   | φ8*30MM   | φ8*50MM   | φ8*40MM   | φ6MM  | φ8MM  | φ8*20MM   | φ6*50MM   | φ7*35MM   | φ8MM  | φ8MM   |   | H=20CM  |   |   |
| 8PCS   | 6PCS  | 2PCS  | 30PCS   | 2PC   | 58PCS   | 12PCS   | 2PC   | 2PCS  | 10PCS   | 1PC  | 1PC   | 2PCS  | 2PCS  | 2PCS  |

| J   | J1  | K   | N   | O   | P   | S   | T   | T1  | U   | U1   | Y   |
|---|---|---|---|---|---|---|---|---|---|--|---|
|  |  |  |  |  |  |  |  |  |  |  |  |
| H=29CM  | H=32CM  |   |   |   |   |   |   |   |   |  |   |
| 1PCS  | 1PCS  | 2PCS  | 12PCS   | 2PCS  | 4PCS  | 1PC   | 1PC   | 4PC   | 2PCS  | 2PCS   | 1PC   |

③

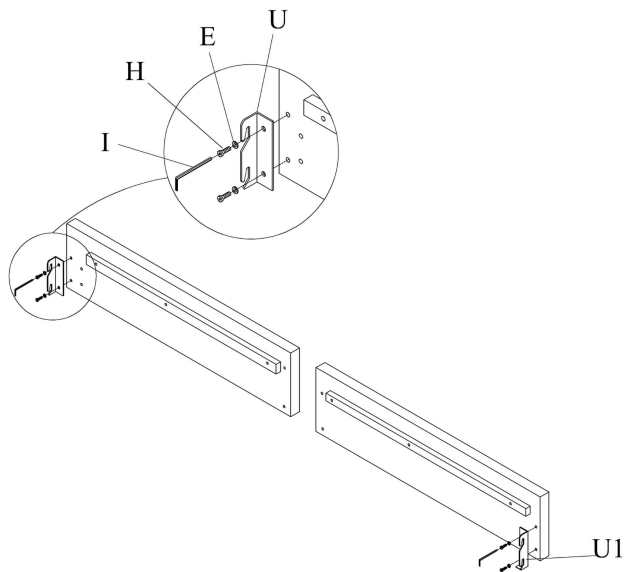

④

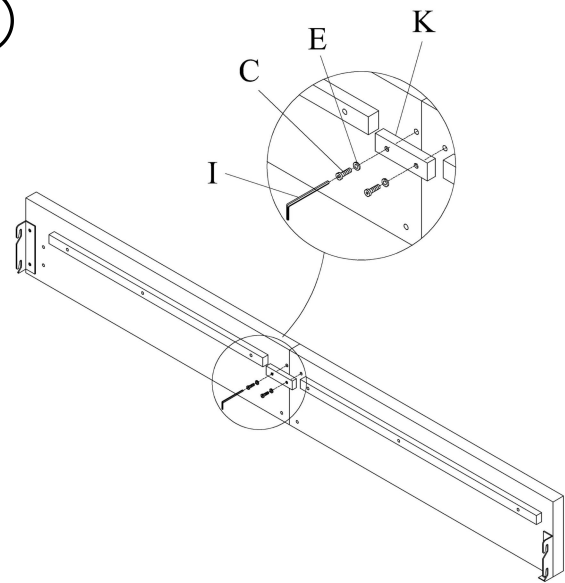

### Step#3

Attach Hanger (U) (U1) to Bed Side Rail using Bolt (H) and Washer (E) by Wrench(I) fasten.

### Step#4

Attach Wooden part (K) to Bed Side Rail using Bolt (C) and Washer (E) by Wrench(I) fasten.















CONGRATULATIONS ON YOUR NEW BED PURCHASE













~Warning: do not move bed after final assembly as it may result in damages to floor and/or bed.~

# Hope & Living Furniture

## ZX-970 Double Assembly instructions

Hardware included in carton.

| A1   | A   | B   | C   | D   | E   | H   | M   | R   | Z   | I  | I2  | F   | F2  | F3  |
|--|---|---|---|---|---|---|---|---|---|--|---|---|---|---|
|  |  |  |  |  |  |  |  |  |  |  |  |  |  |  |
| φ8MM   | φ8*30MM   | φ8*50MM   | φ8*40MM   | φ6MM  | φ8MM  | φ8*20MM   | φ6*50MM   | φ7*35MM   | φ8MM  | φ8MM   |   | H=20CM  |   |   |
| 8PCS   | 6PCS  | 2PCS  | 30PCS   | 2PC   | 58PCS   | 12PCS   | 2PC   | 2PCS  | 10PCS   | 1PC  | 1PC   | 2PCS  | 2PCS  | 2PCS  |

| J   | J1  | K   | N   | O   | P   | S   | T   | T1  | U   | U1   | Y   |
|---|---|---|---|---|---|---|---|---|---|--|---|
|  |  |  |  |  |  |  |  |  |  |  |  |
| H=29CM  | H=32CM  |   |   |   |   |   |   |   |   |  |   |
| 1PCS  | 1PCS  | 2PCS  | 12PCS   | 2PCS  | 4PCS  | 1PC   | 1PC   | 4PC   | 2PCS  | 2PCS   | 1PC   |

5

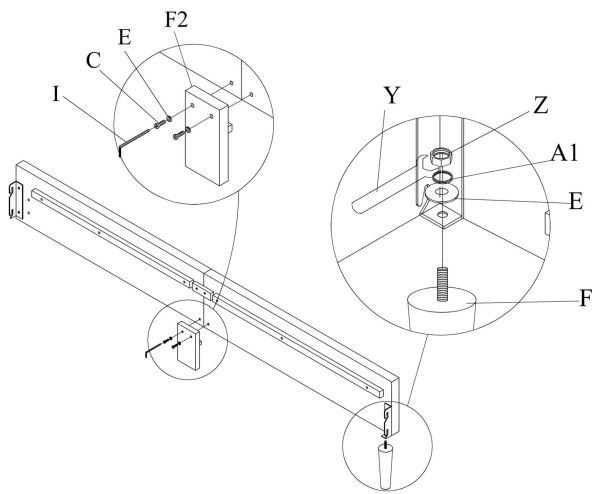

6

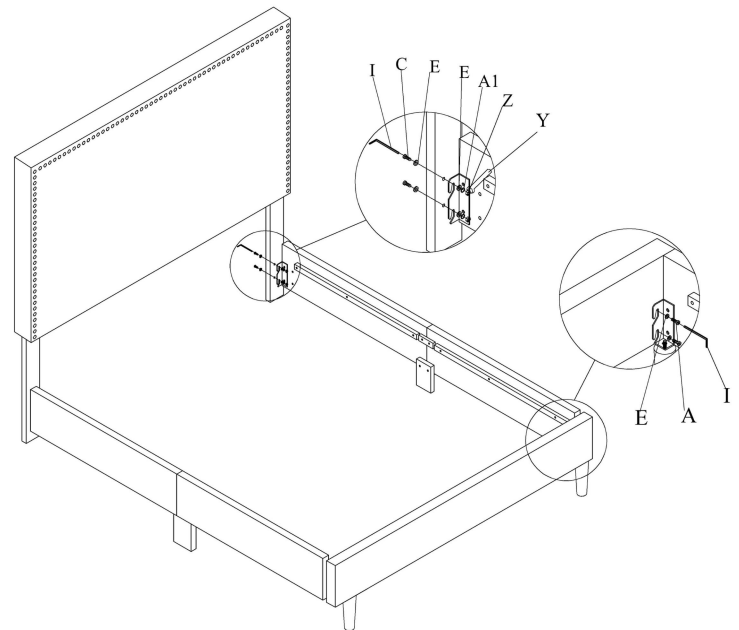

### Step#5

Attached Wooden Part (F2) to Bed Side Rail using Bolt (C), Washer (E) by Wrench (I) fasten .

Attached Wooden Leg (F) to Bed Side Rail using Washer (E), Spring Washer (A1), Nut (Z) by Wrench (Y) fasten.

### Step#6

Attached Bed Side Rail to Headboard using Bolt (C), Washer (E), by Wrench (I) fasten; and using Washer (E), Spring Washer (A1), Nut (Z) by Wrench (Y) fasten.

Attached Bed Side Rail to Foot-board using Bolt (A), Washer (E) by Wrench (I) fasten.















CONGRATULATIONS ON YOUR NEW BED PURCHASE













~Warning: do not move bed after final assembly as it may result in damages to floor and/or bed.~

# Hope & Living Furniture

## ZX-970 Double Assembly instructions

Hardware included in carton.

| A1   | A   | B   | C   | D   | E   | H   | M   | R   | Z   | I  | I2  | F   | F2  | F3  |
|--|---|---|---|---|---|---|---|---|---|--|---|---|---|---|
|  |  |  |  |  |  |  |  |  |  |  |  |  |  |  |
| φ8MM   | φ8*30MM   | φ8*50MM   | φ8*40MM   | φ6MM  | φ8MM  | φ8*20MM   | φ6*50MM   | φ7*35MM   | φ8MM  | φ8MM   |   | H=20CM  |   |   |
| 8PCS   | 6PCS  | 2PCS  | 30PCS   | 2PC   | 58PCS   | 12PCS   | 2PC   | 2PCS  | 10PCS   | 1PC  | 1PC   | 2PCS  | 2PCS  | 2PCS  |

| J   | J1  | K   | N   | O   | P   | S   | T   | T1  | U   | U1   | Y   |
|---|---|---|---|---|---|---|---|---|---|--|---|
|  |  |  |  |  |  |  |  |  |  |  |  |
| H=29CM  | H=32CM  |   |   |   |   |   |   |   |   |  |   |
| 1PCS  | 1PCS  | 2PCS  | 12PCS   | 2PCS  | 4PCS  | 1PC   | 1PC   | 4PC   | 2PCS  | 2PCS   | 1PC   |

7

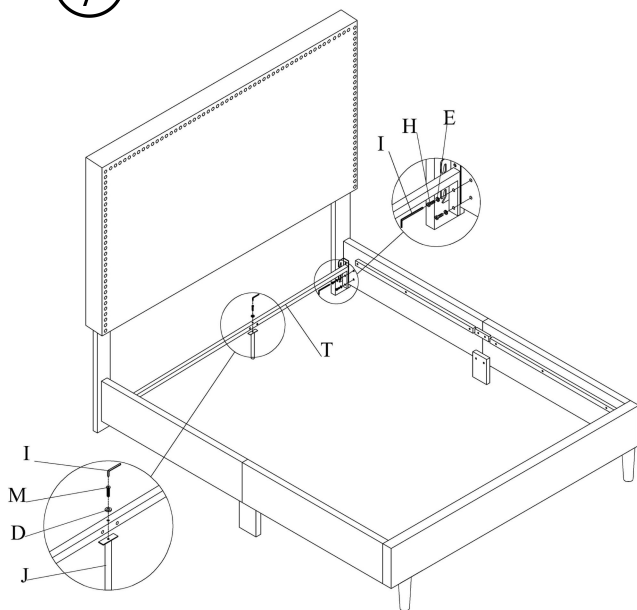

8

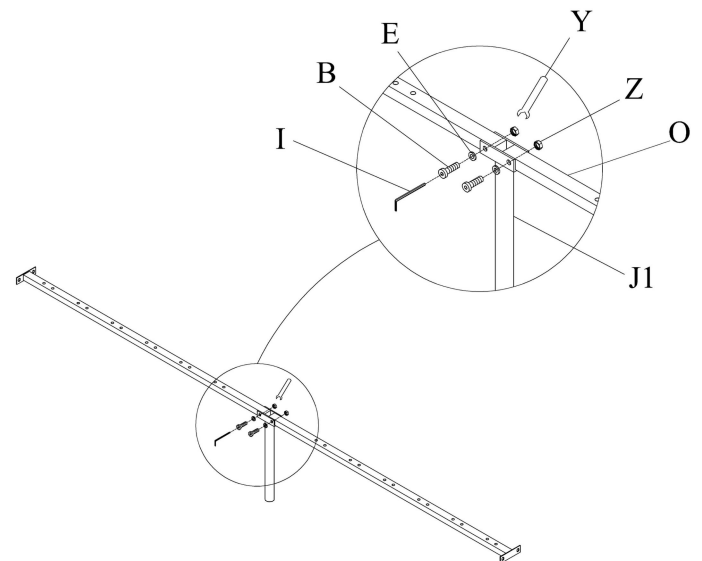

### Step#7

Attach Metal Pole (T) to Bed Side Rail using Bolt (H), Washer (E) by Wrench (I) fasten.  
Attach Support Leg (J) to Metal Pole (T) using Bolt (M), Washer (E) by Wrench (I) fasten.

### Step#8

Attach Support Leg (J1) to Center pole (O), using Bolt (B), Washer (E) by Wrench (I) fasten, and using Nut (Z), by Wrench (Y) fasten.















CONGRATULATIONS ON YOUR NEW BED PURCHASE













~Warning: do not move bed after final assembly as it may result in damages to floor and/or bed.~

# Hope & Living Furniture

## ZX-970 Double Assembly instructions

Hardware included in carton.

| A1   | A   | B   | C   | D   | E   | H   | M   | R   | Z   | I  | I2  | F   | F2  | F3  |
|--|---|---|---|---|---|---|---|---|---|--|---|---|---|---|
|  |  |  |  |  |  |  |  |  |  |  |  |  |  |  |
| φ8MM   | φ8*30MM   | φ8*50MM   | φ8*40MM   | φ6MM  | φ8MM  | φ8*20MM   | φ6*50MM   | φ7*35MM   | φ8MM  | φ8MM   |   | H=20CM  |   |   |
| 8PCS   | 6PCS  | 2PCS  | 30PCS   | 2PC   | 58PCS   | 12PCS   | 2PC   | 2PCS  | 10PCS   | 1PC  | 1PC   | 2PCS  | 2PCS  | 2PCS  |

| J   | J1  | K   | N   | O   | P   | S   | T   | T1  | U   | U1   | Y   |
|---|---|---|---|---|---|---|---|---|---|--|---|
|  |  |  |  |  |  |  |  |  |  |  |  |
| H=29CM  | H=32CM  |   |   |   |   |   |   |   |   |  |   |
| 1PCS  | 1PCS  | 2PCS  | 12PCS   | 2PCS  | 4PCS  | 1PC   | 1PC   | 4PC   | 2PCS  | 2PCS   | 1PC   |

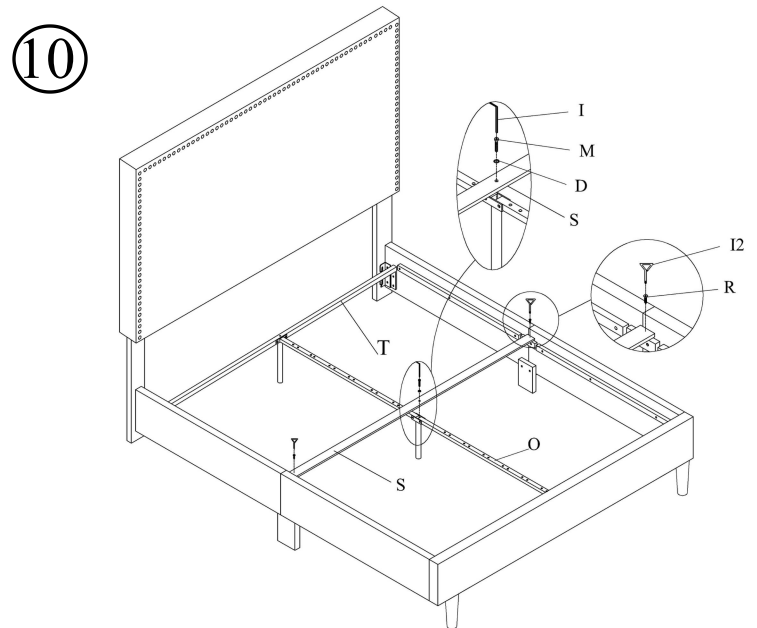
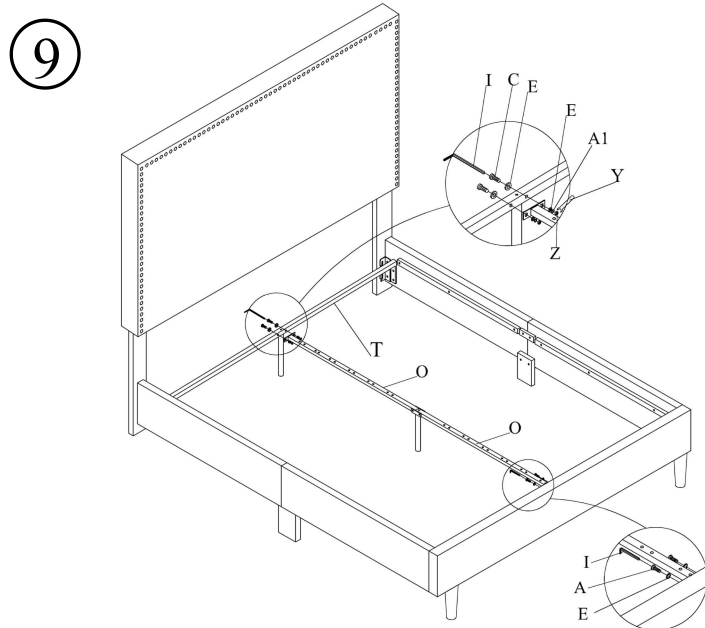

### Step#9

Attach Center Pole (O) to Foot-board using Bolt (A), Washer (E), by Wrench (I) fasten.

Attach Center Pole (O) to Metal Pole (T) using Bolt (C), Washer (E) by Wrench (I) fasten, and using Nut (Z), Washer (E), Spring Washer (A1) by Wrench (Y) fasten.

### Step#10

Attach Wooden strip (S) to Bed Side Rail using Bolt (R) by Wrench (I2) fasten.

Attach Wooden strip (S) to Center Pole (O) using Bolt (M), Washer (D) by Wrench (I) fasten.















CONGRATULATIONS ON YOUR NEW BED PURCHASE













~Warning: do not move bed after final assembly as it may result in damages to floor and/or bed.~

# Hope & Living Furniture

## ZX-970 Double Assembly instructions

Hardware included in carton.

| A1   | A   | B   | C   | D   | E   | H   | M   | R   | Z   | I  | I2  | F   | F2  | F3  |
|--|---|---|---|---|---|---|---|---|---|--|---|---|---|---|
|  |  |  |  |  |  |  |  |  |  |  |  |  |  |  |
| φ8MM   | φ8*30MM   | φ8*50MM   | φ8*40MM   | φ6MM  | φ8MM  | φ8*20MM   | φ6*50MM   | φ7*35MM   | φ8MM  | φ8MM   |   | H=20CM  |   |   |
| 8PCS   | 6PCS  | 2PCS  | 30PCS   | 2PC   | 58PCS   | 12PCS   | 2PC   | 2PCS  | 10PCS   | 1PC  | 1PC   | 2PCS  | 2PCS  | 2PCS  |

| J  | J1  | K   | N   | O   | P   | S   | T   | T1  | U   | U1   | Y   |
|--|---|---|---|---|---|---|---|---|---|--|---|
|  |  |  |  |  |  |  |  |  |  |  |  |
| H=29CM   | H=32CM  |   |   |   |   |   |   |   |   |  |   |
| 1PCS   | 1PCS  | 2PCS  | 12PCS   | 2PCS  | 4PCS  | 1PC   | 1PC   | 4PC   | 2PCS  | 2PCS   | 1PC   |

11

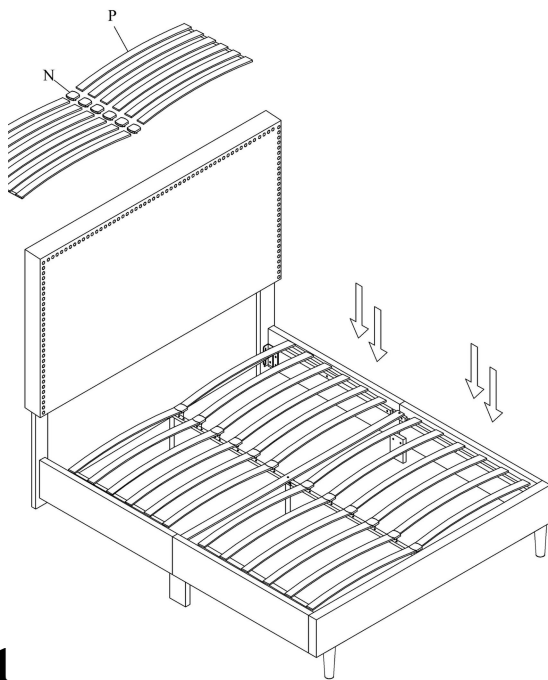

12

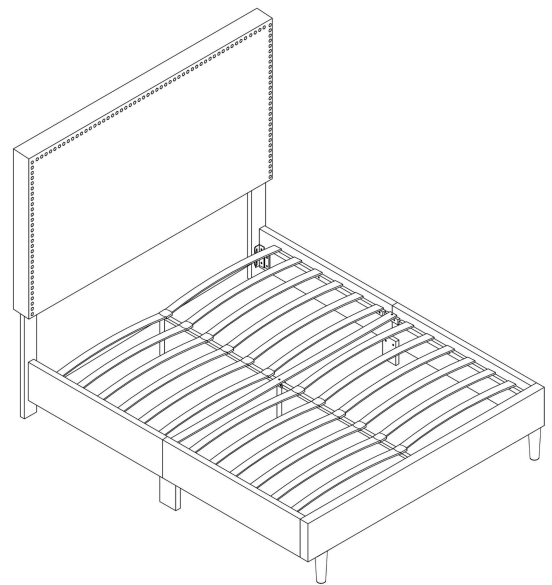

### Step#11

Attach Slats (P) connect by Black Plastic cover (N), and stick on Bed Side Rail.

### Step#12

Installation finish, Don't move bed horizontally.

CONGRATULATIONS ON YOUR NEW BED PURCHASE

~Warning: do not move bed after final assembly as it may result in damages to floor and/or bed.~