

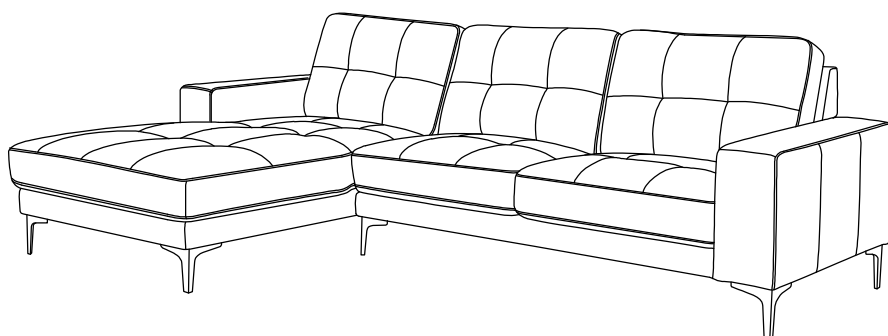

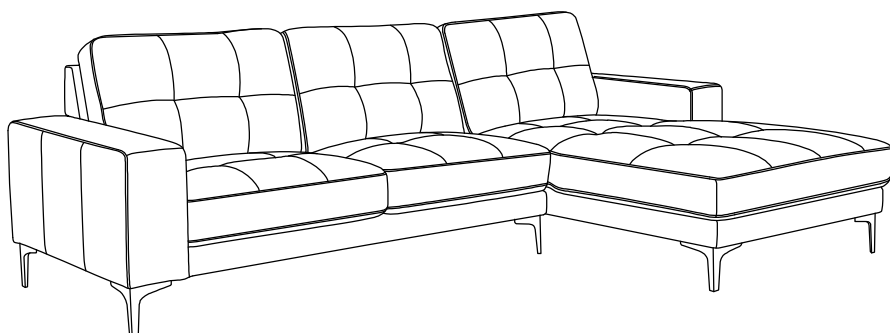



**ASSEMBLY INSTRUCTIONS / INSTRUCTIONS  
D'ASSEMBLAGE / INSTRUCTIVO DE ARMADO**



# NOTES ON ASSEMBLY / NOTES POUR L'ASSEMBLAGE / NOTAS SOBRE EL ENSAMBLE

- To ensure ease of assembly read all instructions before assembly and follow step by step illustrations.
- Keep instructions for future use.
- Adult assembly required.  2 person required. 
- Due to the presence of small parts during assembly, keep out of reach of children until assembly is complete.

- Pour assurer l'assemblage facile veuillez lire toutes les instructions avant l'assemblage et veuillez suivre les illustrations pour chaque étapes.
- Veuillez garder ces instructions pour l'usage ulterieur.
- Assemblage requis par un adulte.  2 personnes requises. 
- Due a la presence de petite pieces durant l'assemblage, veuillez garder hors de portee des enfants jusqu'a ce que l'assemblage soit complet.

- Para garantizar la facilidad de ensamble lea las instrucciones antes de iniciar y siga paso a paso las ilustraciones.
- Guarde las instrucciones para futuras referencias.
- El ensamble requiere de un adulto.  2 personas requeridas. 
- Debido a que hay piezas pequeñas, mantenga fuera del alcance a los niños durante el ensamble, hasta que haya terminado.

## MAINTENANCE TIPS / CONSEILS D'ENTRETIEN / CONSEJOS DE MANUTENIMIENTO



- Never let liquids or damp cloths sit on this furniture.
- Never use chemical cleaning products. They can damage the finish. For cleaning, use only a slightly damp cloth and wipe dry.
- To avoid dulling of the finish, do not place furniture in direct sunlight.
- Do not put plastic or rubber rings under appliances. Use cloth or felt protectors.
- To clean, use a soft or slightly damp cloth, then wipe with a clean, dry cloth.

- Ne jamais laisser de liquide ou linge humide sur le meuble.
- Ne jamais utiliser de nettoyeurs à base de produits chimiques, cela va endommager le fini. Utiliser seulement un linge légèrement humide.
- Ne pas placer le meuble directement au soleil pour prévenir le ternissement.
- Évitez de déposer des appareils avec des rondelles de plastique ou de caoutchouc. Utilisez un protecteur en tissu ou en feutre.
- Pour nettoyer, utilisez un linge doux ou légèrement humecté. Essuyez par la suite avec un linge propre et sec.

- Nunca deje un líquido o un trapo húmedo sobre el mueble.
- Nunca utilice limpiadores a base de químicos, estos dañaran el acabado. Use sólo un paño húmedo.
- No exponga el mueble directamente al sol para prevenir empañamiento.
- Evite apoyar aparatos con redondeles de plástico o de goma. Utilizar un protector de tela o de fieltro.
- Para limpiar, utilice un trapo suave o ligeramente humedecido. Seque luego con un trapo limpio y seco.

# HARDWARE

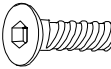
## QUINCAILLERIE / HERRAJE

(A)	<b>Metal Leg</b> 	(B)	<b>JCBC Bolt M8 x 20mm</b> 	(C)	<b>Allen Key M5 x 65mm</b> 
	<b>9 Units</b>		<b>18 Units</b>		<b>2 Units</b>

- Hardware quantity may supplied more than it required. Please keep spares and tools for future use.
- La cantidad de hardware puede suministrarse más de lo requerido. Guarde los repuestos y las herramientas para uso futuro.
- La quantité de matériel peut fournir plus que nécessaire. Veuillez conserver les pièces de rechange et les outils pour une utilisation future.

## TOOLS NOT INCLUDED

## OUTILS PAS INCLUS / HERRAMIENTAS NO INCLUIDAS

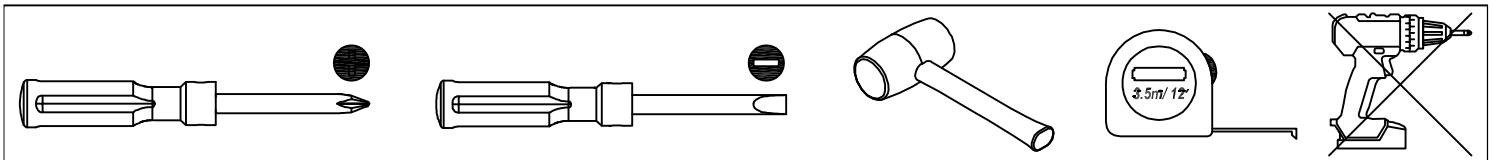

**PARTS IDENTIFICATION**  
**IDENTIFICATION DES PIÈCES**  
**IDENTIFICACIÓN DE LAS PARTES**

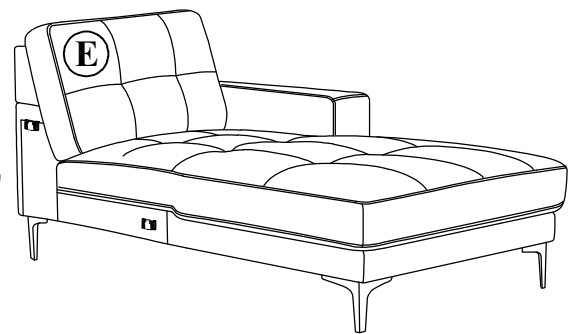
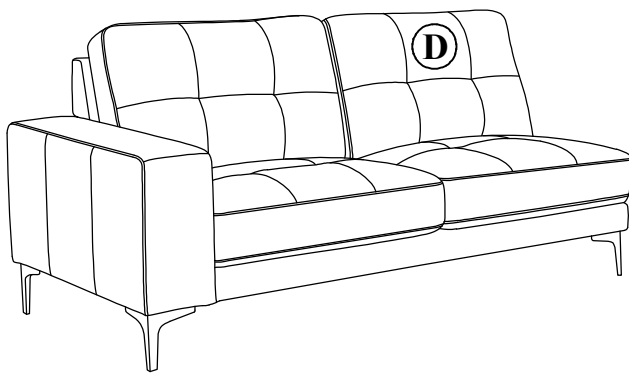

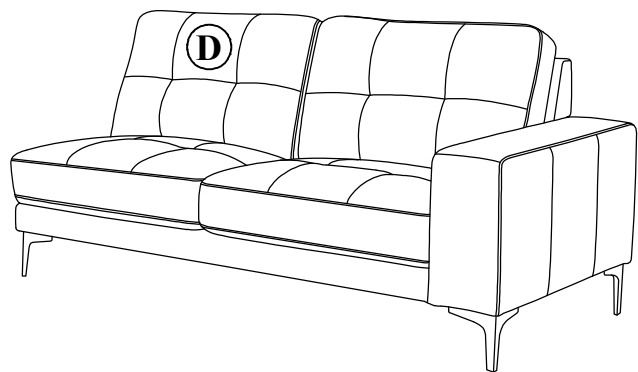
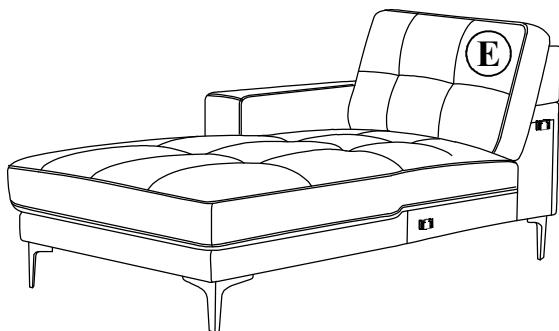

● **Right Chaise**



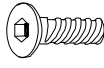

● **Left Chaise**

# STEP 1

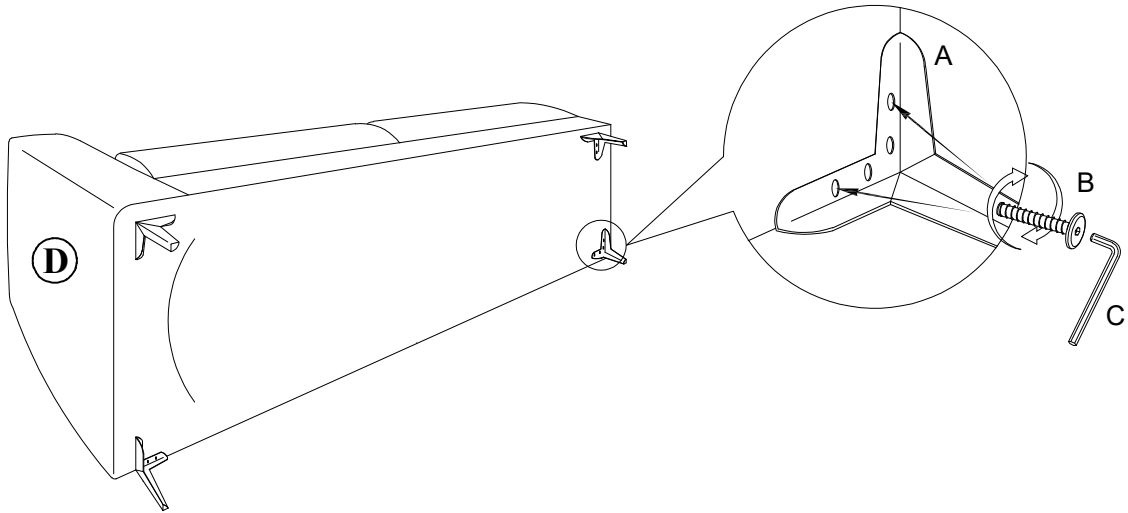
		
<b>A x 4</b>	<b>B x 8</b>	<b>C x 1</b>

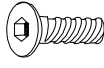

# STEP 2

		
<b>A x 5</b>	<b>B x 10</b>	<b>C x 1</b>

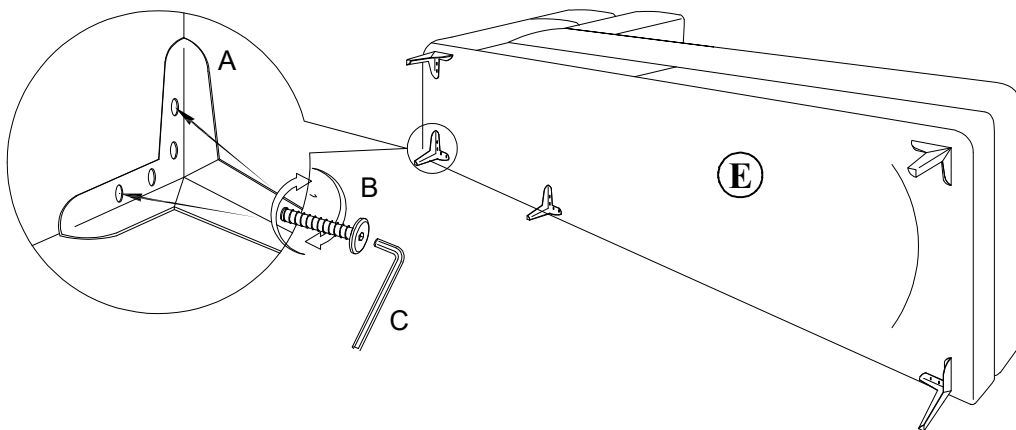

# STEP 3

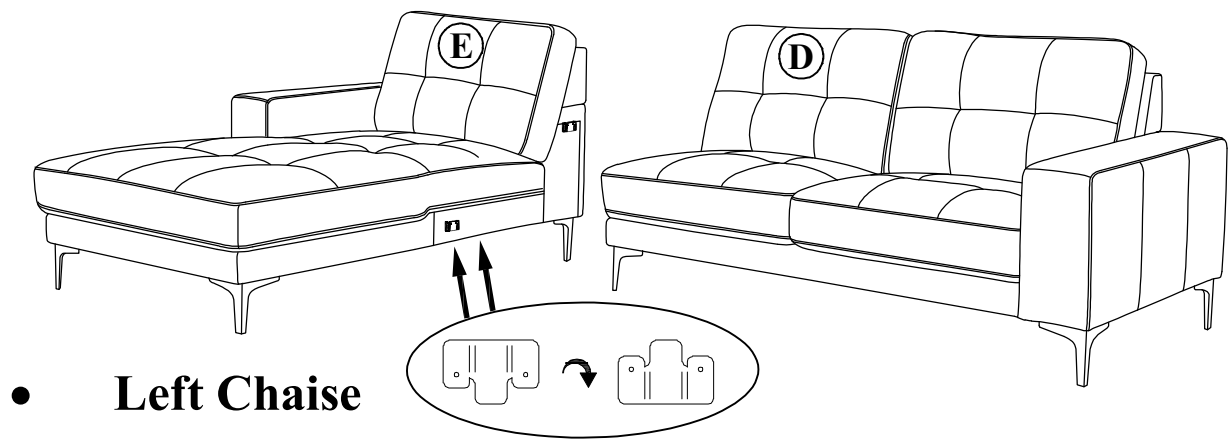
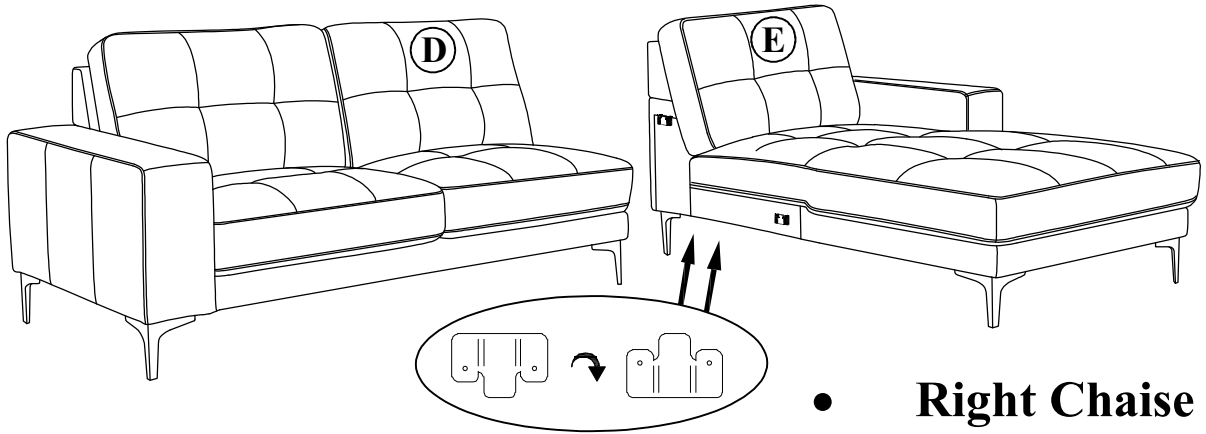

# MAXIMUM LOADS CHARGES MAXIMALES / CARGA MAXIMA

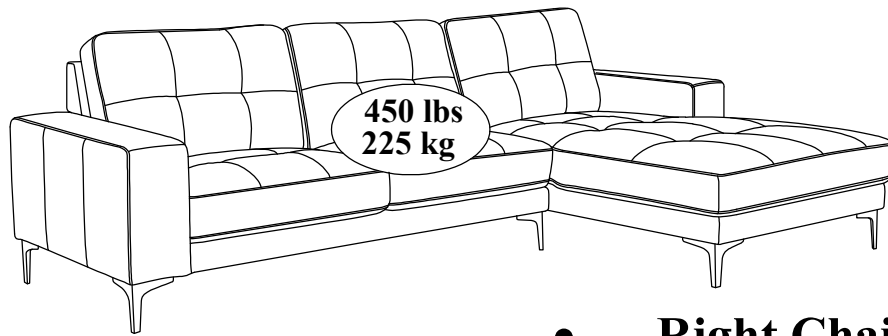

- **Right Chaise**

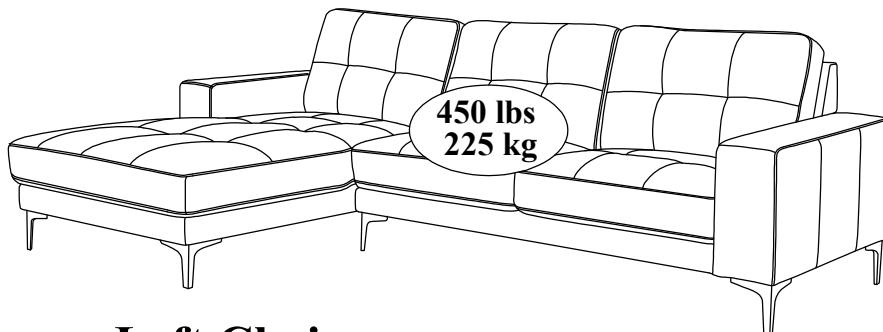

- **Left Chaise**

---

This product is designed to withstand the weight noted on the plan. We are not responsible for the breakage of parts or any injury caused by failure to comply with this recommendation.

---

Ce produit est conçu pour supporter le poids indiqué sur le plan. Nous ne sommes pas responsables de la casse de pièces ou toute blessure causée par le non-respect de cette recommandation.

---

Este producto está diseñado para soportar el peso indicado en el plano. No somos responsables de la rotura de piezas o cualquier lesión causada por el incumplimiento de esta recomendación.

---