

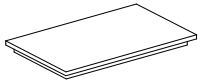

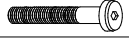

ASSEMBLY INSTRUCTION

DIMENSINONS : 60"L x 36"W x 30"H

Item No : F2093/F2566
Description : Dining Table

No	LIST OF PAST	Q'TY	No	LIST OF HARDWARE	Q'TY
1	TABLE TOP 	1pc	A	BOLT 	Ø5/16" x 63.5mm 8pcs
2	TABLE LEG 	4pcs	B	LOCK WASHER 	Ø5/16" 8pcs
			C	WASHER 	Ø5/16" x 22 x 2 8pcs
			D	ALLEN KEY 	4 mm 1pc

STEP 1

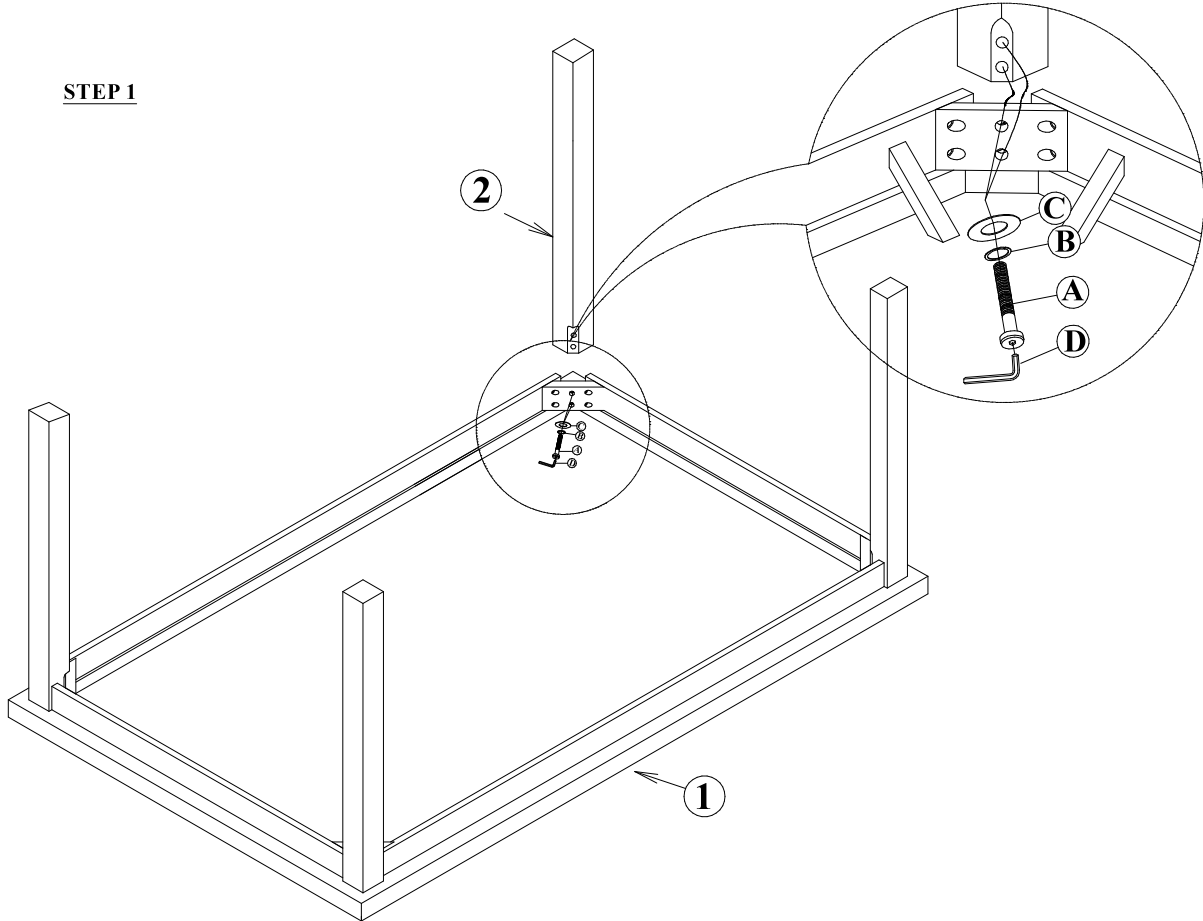

STEP 2

