

SOPU3104TPG



Category	30"
Product family	Oven
Power supply	Electrical
Power supply	Electricity
Cooking method	Thermo-ventilated
Cleaning system	Self-cleaning
EAN code	8017709329389



Aesthetic

Aesthetics	Linea	Silkscreen color	Black
Color	Neptune Grey	Silkscreen type	Symbols and wordings
Design	Flat	Door	Full-glass
Material	Glass	Handle	Neptune 30" BIG
Stainless steel type	Brushed	Handle color	Stainless steel
Glass type	Clear1	Logo	Silkscreened

Controls

			
Display name	VivoScreen	No. of display languages	7
Display technology	TFT	Display languages	Italiano, English (US), Français (CA), Español (MX), Português (PT), zh-CHS, zh-CHT
Controls setting	Advanced full touch		

Programs / Functions

No. of cooking functions	10
Automatic programmes	50

Traditional cooking functions

Static	Fan-assisted	True European convection
Turbo	Eco	Large grill
Fan grill (large)	Bottom	Circular heating element + Bottom
Pizza		

Other functions

Defrost by time	Defrost by weight	Proof
Keep-warm	Plate warmer	Sabbath

Cleaning functions

Self-cleaning cycle

Options



Time-setting options	Delayed start and automatic shut-off when cooking ends	Smart cooking	Yes
Minute minder	Yes	Showroom mode	Yes
Timer	1	Chronology	Last 10 functions operated
Other options	Keep-warm, Eco light, Language setting, Digital clock, On/off tones	Rapid pre-heating	Yes
Cooking with food probe	Yes		

Technical Features



Minimum Temperature	32 °F	Heating elements stop when door is opened	Yes
Maximum temperature	282 °F	Door opening	Standard opening
No. of shelves	5	Door	Cool-touch door
Fan	Single	Removable door	Yes
No. of lights	2	Full-glass inner door	Yes
Lighting	Halogen	Total no. of door glasses	4
Replaceable light	Yes	Cooling system	Tangential
Light power	40 W	Cooling duct	Double
Light on when door is open	Yes		

Lower heating element power	1700 W	Cooling System Speed Reduction	Yes
Upper heating element - Power	1200 W	Door lock during self-cleaning cycle	Yes
Grill element - power	1700 W	Inner cavity dimensions (HxWxD)	442x585x437 mm
Large grill - Power	2900 W	Temperature control	Electronic
Circular heating element - Power	2000 W	Cavity material	EverClean enamel

Performance / Energy Label

	Energy efficiency class	A	Energy consumption in forced air convection	3.06 MJ
	Volume of the cavity	3.99 cu. ft.	Energy consumption per cycle in fan-forced convection mode	0.85 kWh
	Energy consumption per convection cycle	1.00 kWh	Number of cavities	1
	Energy consumption in conventional mode	3.60 MJ	Energy efficiency index	83.3 %

Accessories Included

		Rack with back stop	3	Telescopic Guide rails, total Extraction	2
		Enameled 1.6"-deep tray	1	Temperature probe	Yes, multi-point probe
		Insert grid	1		

Electrical Connection

Voltage	120/240 V	Current	20 A
Plug	Hard-wired	Frequency	60 Hz
Nominal power	5900 W	Power cord length	59 1/16 "
Voltage	120/208 V		

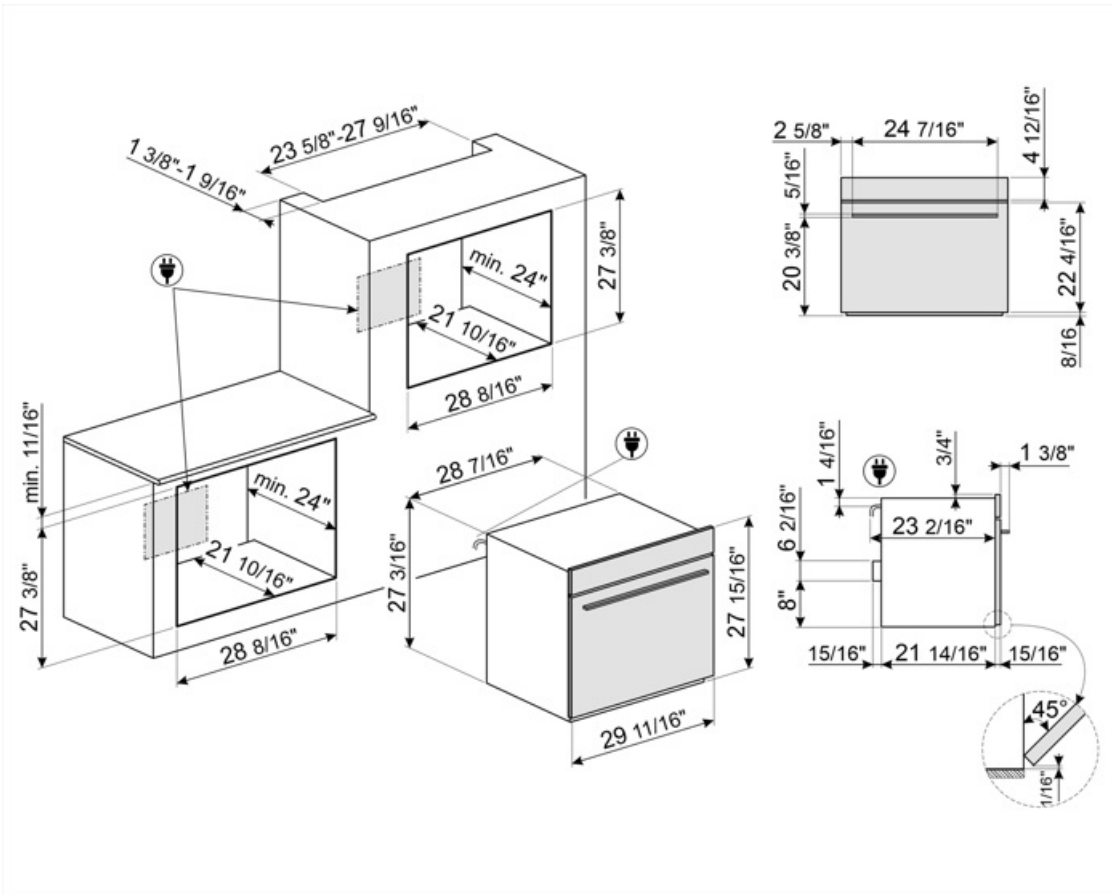



















Alternative products





















SOPU3304TPX

Stainless steel

Symbols glossary

 <p>A: Product drying performance, measured from A+++ to D / G depending on the product family</p>	 <p>Child lock: some models are fitted with a device to lock the programme/cycle so it cannot be accidentally changed.</p>
 <p>Air cooling system: to ensure a safe surface temperatures.</p>	 <p>Defrost by time: with this function the time of thawing of foods are determined automatically.</p>
 <p>Defrost by weight: With this function the defrosting time is determined</p>	 <p>Quadruple glazed: Number of glazed doors.</p>
 <p>Automatic lighting switches off: for greater energy savings, the lighting switches off automatically after one minute from the start of cooking.</p>	 <p>Electric</p>
 <p>Enamel interior: The enamel interior of all Smeg ovens have a special antacid lining which helps keep the interior clean by reducing the amount of cooking grease adhering to it.</p>	 <p>Fresh Touch: Most of Smeg ovens have a "cool door." Thanks to the combination of tangential cooling and internal heat-reflecting glasses, the temperature on the outer surface of the door is maintained below 50° C. In addition to providing safety, this system protects the sides of the furniture from overheating by the oven.</p>
 <p>Fan with upper and lower elements: The elements combined with the fan aim to provide more uniform heat, a similar method to conventional cooking, so pre-heat is required. Most suitable for items requiring slow cooking methods.</p>	 <p>Upper and lower element only: a traditional cooking method best suited for single items located in the centre of the oven. the top pf the oven will always be hottest. Ideal for roast, fruit cakes, bread etc.</p>
 <p>Lower heating element only: This function is ideal for foods that require extra base temperature without browning, e.g. pastry dishes, pizza. Also suitable for slow cooking of stews and casseroles.</p>	 <p>Circulaire with lower element: The addition of the lower element adds extra heat at the base for food which requires extra cooking.</p>
 <p>True European Convection: The combination of the fan and circular heating element around it provides many benefits, including no preheat if cooking time is longer than 20 minutes, no flavor transfer when cooking different foods at the same time, lower energy consumption, and shorter cooking times. Suitable for all types of food preparations.</p>	 <p>ECO: The combination of the grill, fan and lower element is particularly suitable for cooking small quantities of food.</p>
 <p>Grill element: Using of grill gives excellent results when cooking meat of medium and small portions, especially when combined with a rotisserie (where possible). Also ideal for cooking sausages and bacon.</p>	 <p>Fan with grill element: The fan reduces the fierce heat from the grill, providing an excellent method of grilling various foods, chops, steaks, sausages etc. giving even browning and heat distribution, without drying out the food. The top two levels recommended for use, and the lower part of the oven can be used to keep items warm at the same time, an excellent facility when cooking a grilled breakfast. Half grill (centre portion only) is ideal for small quantities of food.</p>

- | | |
|--|---|
|  <p>Pizza function: The simultaneous operation of three elements ensures an optimum cooking facility when used with the Smeg pizza stone.</p> |  <p>Circulaire with upper and lower elements: The use of the fan with both elements allows food to be cooked quickly and effectively, ideal for large joints that require thorough cooking. It offers a similar result to rotisserie, moving the heat around the food, instead of moving the food itself, enabling any size or shape to be cooked.</p> |
|  <p>All glass inner door: All glass inner door, a single flat surface which is simple to keep clean.</p> |  <p>KEEP_WARM_72dpi</p> |
|  <p>Side lights: Two opposing side lights increase visibility inside the oven.</p> |  <p>Pyrolytic: Pyrolytic cleaning cycles can be selected as necessary to automatically clean the oven interior.</p> |
|  <p>Warming up: An option for dish warming and keeping the prepared meals hot.</p> |  <p>Cooking with temperature probe: It is possible to display the temperature detected by the probe and set a target temperature that the dish must reach. When the core of the dish reaches the desired temperature, cooking stops</p> |
|  <p>Air at 40°C provides the perfect environment for proving yeast type dough mixes. Simply select the function and place dough in the cavity for allotted</p> |  <p>Rapid preheat: The rapid preheat function can be used to reach the selected temperature in just a few minutes.</p> |
|  <p>Sabbath: This function allows you to cook food during the Sabbath, the Holiday of rest in the Jewish religion, respecting the precepts.</p> |  <p>The oven cavity has 5 different cooking levels.</p> |
|  <p>Smart Cooking System: for the perfect cooking it is simply necessary choosing the kind and the weight of food and the cooking temperature: any other setting will be established automatically.</p> |  <p>Telescopic rails: allow you to pull out the dish and check it without having to remove it from the oven entirely.</p> |
|  <p>Electronic control: Allows you to maintain temperature inside the oven with the precision 2-3 ° C. This enables to cook meals that are very sensitive to temperature changes, such as cakes, souffles, puddings.</p> |  <p>...</p> |
|  <p>...</p> |  <p>...</p> |