







Assembly Instructions

CAUTION

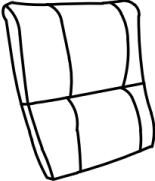
DO NOT use any sharp objects to open plastic wrapped components as this may result damage to product or components .

This product comes four kinds of packages. Carefully remove all of components from the packaging and set aside for assembly

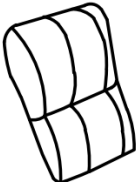
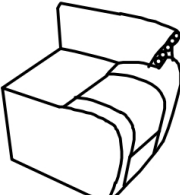
Package Contents

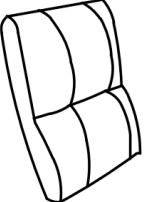
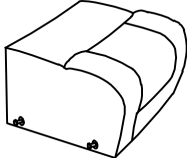
BOX 1				
	A*1	B*1	C*1	
BOX 2				
	D*1	E*1		
BOX 3				
	F*1	G*1	H*1	
BOX 4				
	I*1	J*1		

1 RECLINER ASSEMBLY - BODY SETUP

STEP1:

Attach **Back (B&D&I&F)** to **Seat (C&E&J&G)** by aligning the metal grooves. Next install the **Ears (A&H)** to **Back (B&F)** via aligning the metal sliders, making sure it is securely installed before use. Finally connect the parts of the product assembly by means of the metal clips at the bottom.

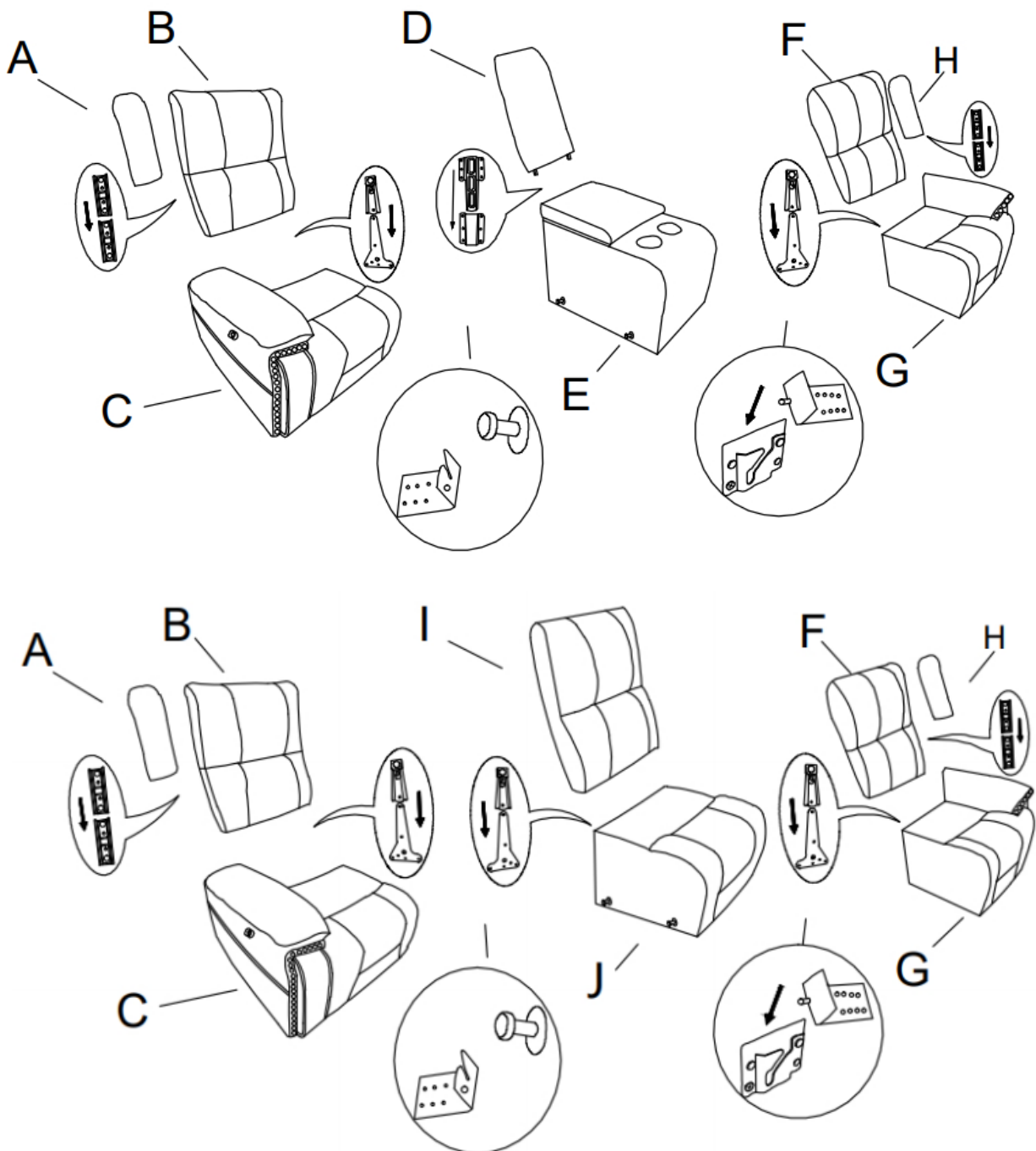

2 RECLINER ASSEMBLY - BODY SETUP

ASSEMBLY COMPLETED

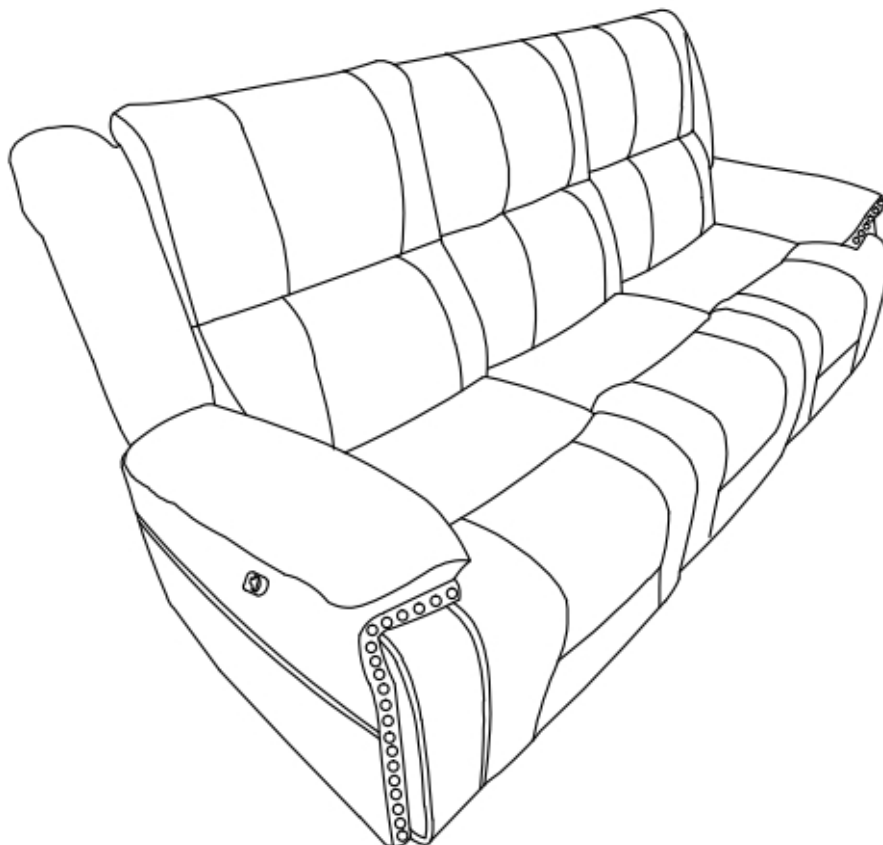
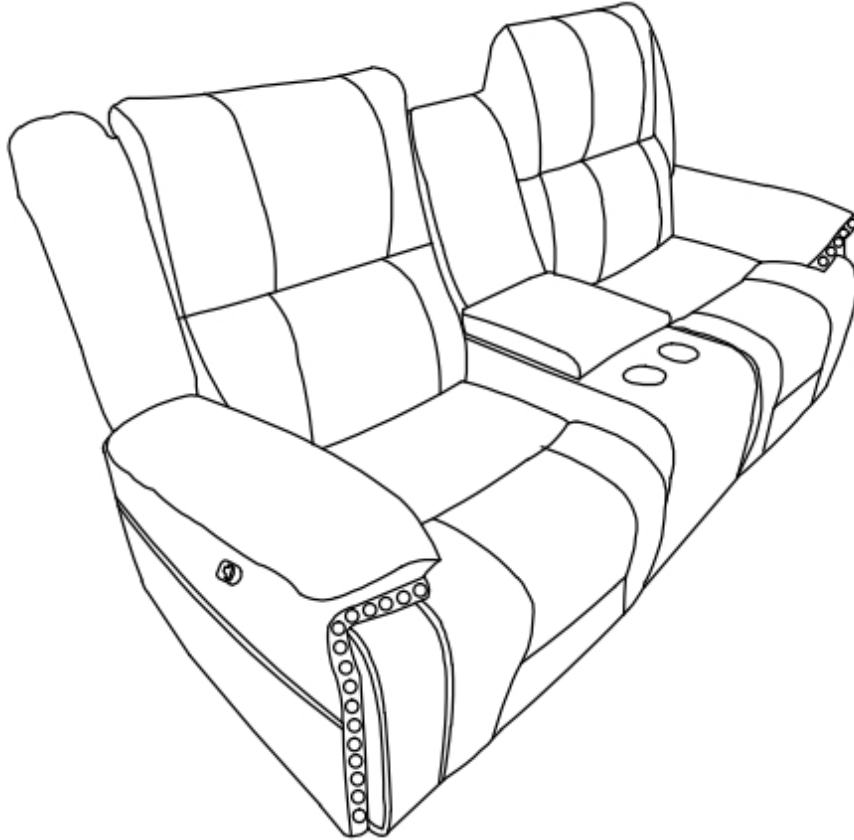

3 INSTRUCTIONS FOR USE - SIZE DIMENSIONS

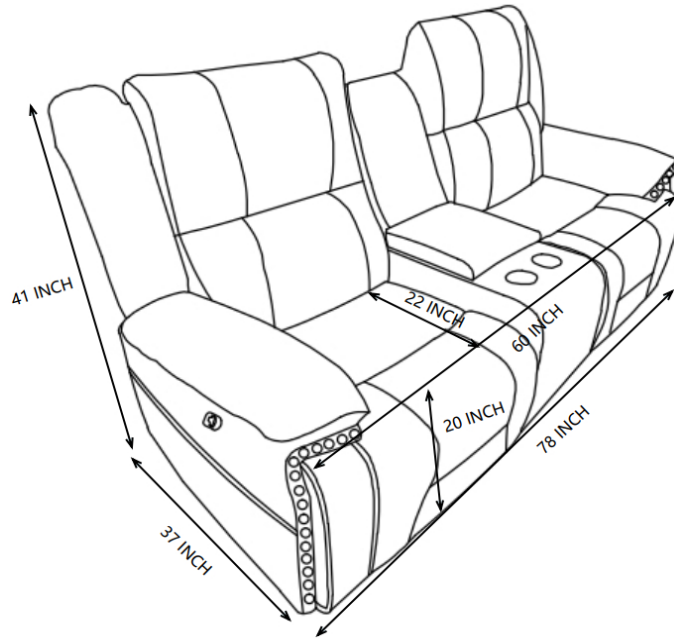

Sofa

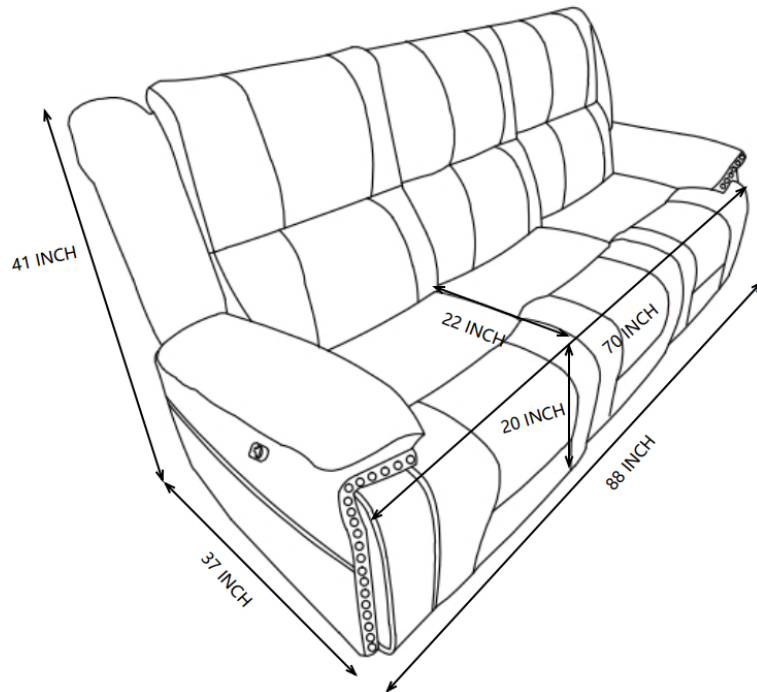

Loveseat

⚠️ WARNINGS

1. Please check if the components of the chair are all included and can be used normally.
2. Assemble all components according to the instruction correctly before you connect the chair to the power.
3. Please DO NOT sit on the armrests or footrest to eliminate the risk of tipping over.
4. If the chair is damaged or doesn't match the website description, please send clear pictures of the product and label of the carton to our service team for further help.
5. If the recliner doesn't work, you may try the following measures for self-checking firstly:
 - a) check if all the cables are connected;
 - b) check if the light of transformer is on.

If the chair still doesn't work, please feed the information back to our customer service in time and we will help you solve the matter as soon as possible.

