

edishinē

Floor Lamp

[Instruction Manual]

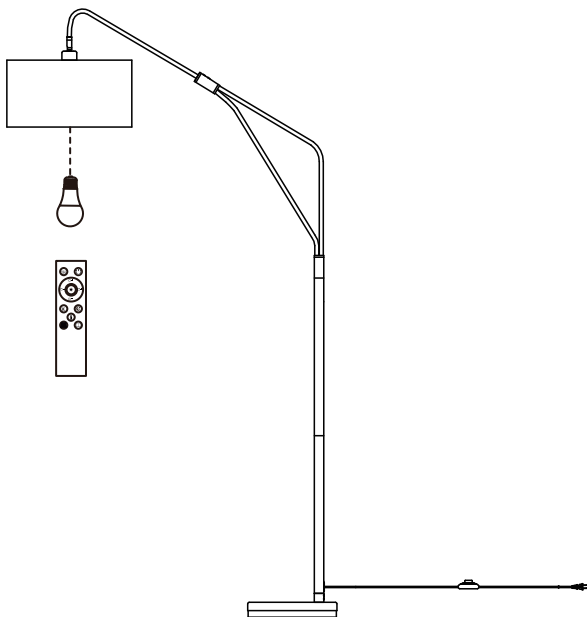

Please pay attention to the warning signs
Read the instructions with caution before operating
and keep it properly





CAUTION

1. Before assembly, place all parts on a clean flat surface and check each part for defects that may occur during shipping.
2. Inspect wire insulation for any cuts, abrasions or exposed copper that may have resulted from shipping. If there are any defects in the wire, **DO NOT** continue assembling. Please send an email to our Customer Service immediately.
3. Consult a qualified electrician if you have any electrical questions.
4. Never drape clothes over the lamp.
5. To reduce the possibility of tipping over, we recommend placing the lamp behind furniture and keep children and pets away.
6. To prevent children from suffocating and choking, keep them away from packing materials.
7. Please keep this manual and hand it over when you transfer the product.

IMPORTANT SAFETY INSTRUCTIONS

This portable lamp has a polarized plug (one blade is wider than the other) as a safety feature to reduce the risk of electric shock. This plug will fit in a polarized outlet only one way. If the plug does not fit fully in the outlet, reverse the plug. If it still does not fit, contact a qualified electrician. Never use with an extension cord unless the plug can be fully inserted. Do not alter the plug.

Packing List:

L x 1 	F1 x 1 
F2 x 1 	F3 x 1 

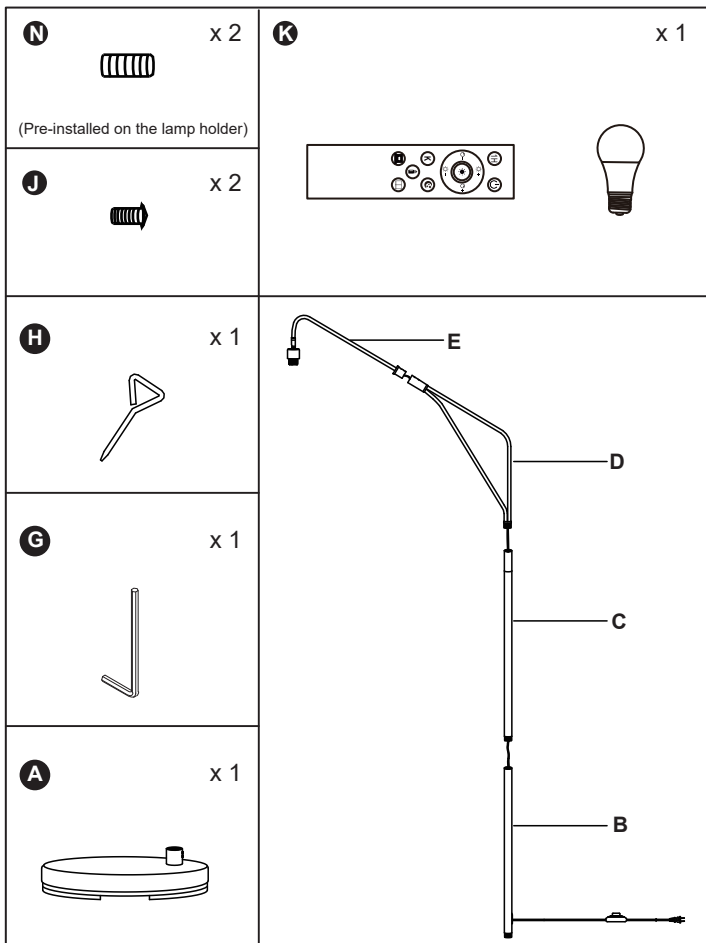

ASSEMBLY INSTRUCTIONS

Before assembly, check the packing listing to make sure all parts are present;

Shade Assembly

1

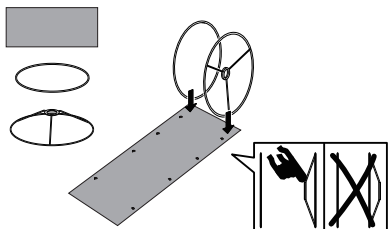

2

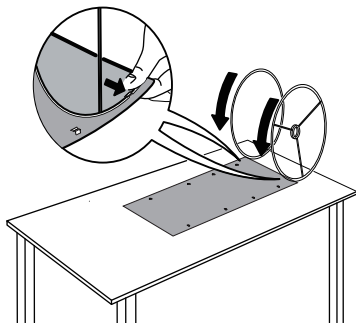

3

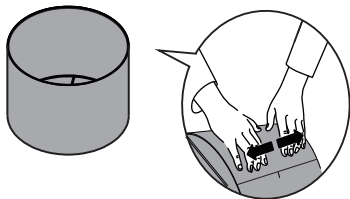

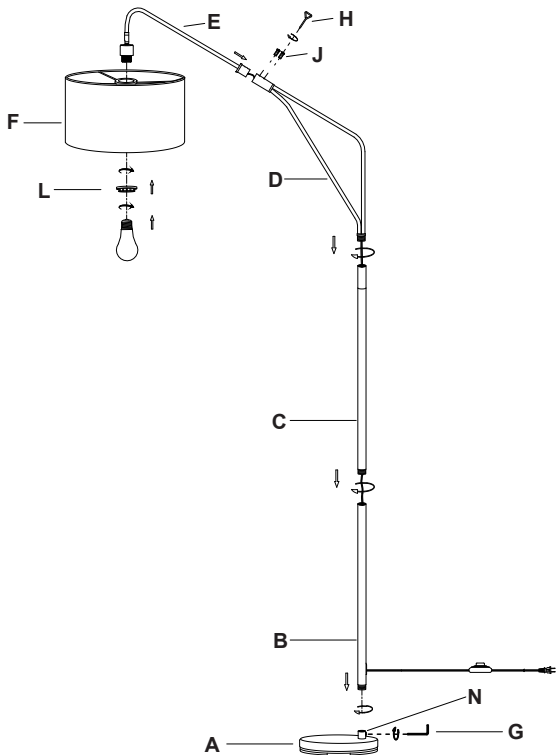

1. Assemble (F1), (F2), and (F3) into shade (F) as shown in the diagram.
2. Connect pipe (B), pipe (C), and pipe (D) .
3. Connect pipe (D) and pipe (E) in sequence using screw (J) with wrench (H).
4. Screw the Base (A) onto pipe (B), screw to the bottom and adjust the direction of the lamp head, then lock the screw (N, already pre-installed in the screw hole) wrench (G) and fix it once.
5. Place the shade (F) on the socket and screw the socket ring (L) to fix the shades.
6. Install the bulb by screwing it into the socket.

Remote control bulb instructions for use

1. Install the bulb to the floor lamp, and insert the batteries into the remote control.
2. Depress the foot switch gently to turn on the floor lamp.
3. Control the bulb with remote control.

NOTE: To control the bulb by remote control, you must plug the floor lamp into the power supply first, then keep the foot switch in the ON state by depressing it gently.

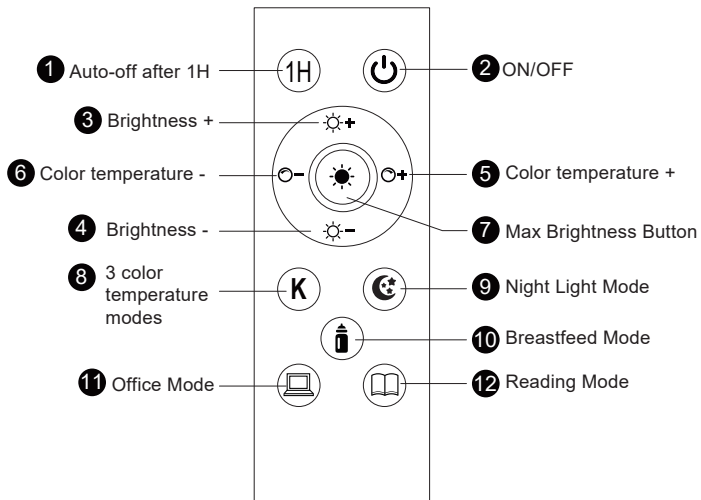

1 Auto-off after 1H:

The bulb flashes once after pressing it, indicating enter the 1-Hour Timer mode; if switch it on/off with foot switch, plug or remote control during the timing period, it will automatically exit the timing function.

2 ON/OFF:

Turn the bulb ON/OFF.

3 Brightness +:

Press the button to increase the brightness, 5 levels in total.

4 Brightness -:

Press the button to decrease the brightness, 5 levels in total.

5 Color temperature +:

Press the button to increase the color temperature, 5 levels in total.

6 Color temperature -:

Press the button to decrease the color temperature, 5 levels in total.

7 Max Brightness Button:

No matter which color temperature is set, press this button once to adjust the brightness to 100% at this color temperature.

8 3 color temperature modes:

Press the button to cycle through the 3 common color temperature modes.

9 Night Light Mode:

Press the button to enter Night Light Mode.

10 Breastfeed Mode:

Press the button to enter Breastfeed Mode.

11 Office Mode:

Press the button to enter Office Mode.

12 Reading Mode:

Press the button to enter Reading Mode.

Specifications:

- Product Height: 76 IN
- Base Diameter: 11.8 IN
- Materials: Metal , Linen
- Input Voltage: 120VAC 60Hz
- Max.Load Power: Incandescent Bulb 60W or LED Bulb 12W
- Socket Type: Standard Medium E26

One Year Limited Warranty

Supported by our professional R&D team and QC team, we provide One Year Warranty for materials and workmanship from the purchase date. Please note that the warranty does not cover damage caused by personal misuse or improper installation.

Please attach your Order ID and Name so that our dedicated customer service team can help you better.