

PURPLE LEAF

est. 2013

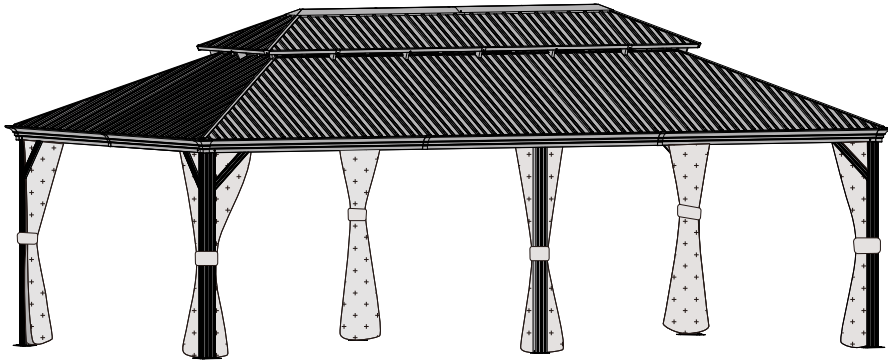

14' x 24'

**HARDTOP GAZEBO
WITH DOUBLE ROOF**

Assembly Manual

©Copyright 2013-2025 Purple Leaf Inc. All Rights Reserved

CONTENT

● Warnings and cautions	1
● Pre-assembly	2
● Anchoring scheme	3
● Check list	6
● Frame installation	15
● Roof frame installation	35
● Roof panel installation	50
● Curtain and netting installation	67
● Care and cleaning	76
● Warranty	77

WARNINGS AND CAUTIONS

1. Please read the instruction carefully before assembly and retain it for future usage.
2. Make sure you have all the parts & hardware as the check list shows before you install.
3. Do not discard or recycle boxes until completely assembled.
4. **4 adults or more** are recommended to install your gazebo.
5. Do not fully tighten the screws until finish each step of installation. Check all bolts for tightness after installation.
6. **Anchor the gazebo as soon as finish Step 2(The frame).**
7. Some parts might have sharp edges/corners. Please follow basic safety precautions to reduce the risk of injuries.
8. Do not install near roof lines or other structures that could shed snow, ice, or excessive rain runoff onto the roof top.

CHOKER HAZARD

This item contains small parts which can be swallowed by children and pets.

Please keep it away from children under 3 years old and pets during installation.

PRE-ASSEMBLY

TOOLS THAT MAY BE REQUIRED (Not included in boxes)
*NOTE: Tools/equipment are not shown to actual size and scale.



LEVEL

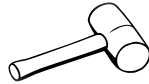

RUBBER Mallet



CROSS SCREWDRIVER



DRILL



ALLEN WRENCH
DRILL BIT(5/32")



ALLEN WRENCH
DRILL BIT(7/32")



SAFETY HAT



GLOVES



SAFETY GOGGLES



STEPLADDER
(6 ft height is recommended)

ANCHORING SCHEME

Gazebo 14'x24'

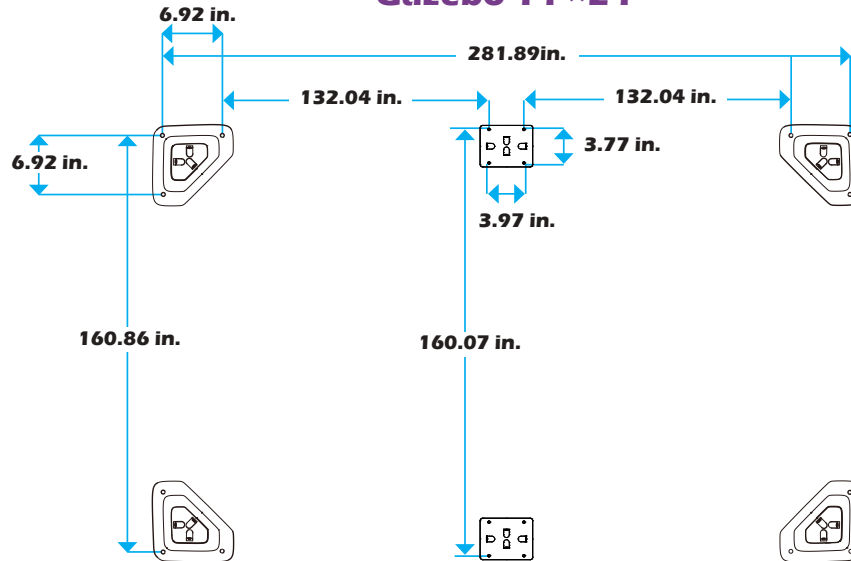

Attention: The above dimensions are manually measured and error is within 1-2 inches.
We suggest you anchor the gazebo after installed the main frame.

1

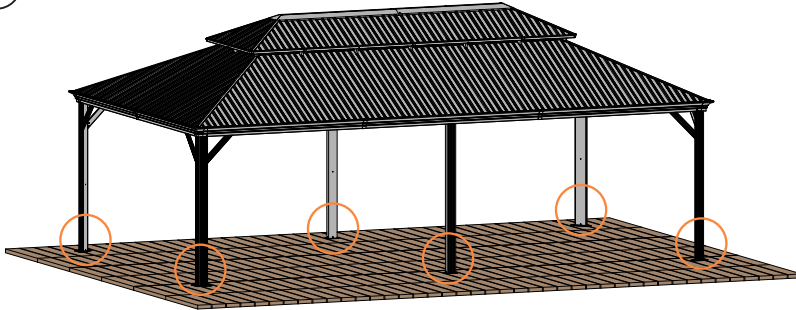

(not included in package)

If the deck is hardwood and the depth of it is over 3 inches, you can use **1/4 in. x 3 in. Structural Wood Screw** to mount the gazebo.

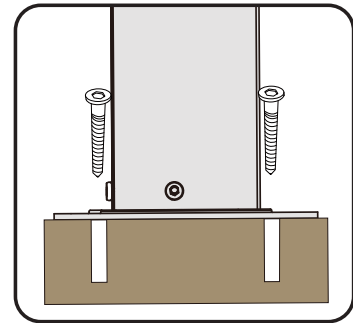
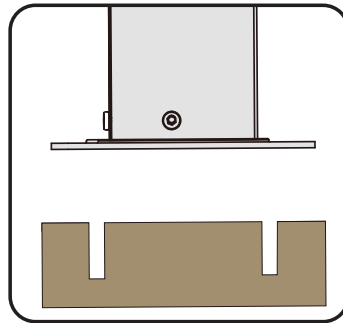

2

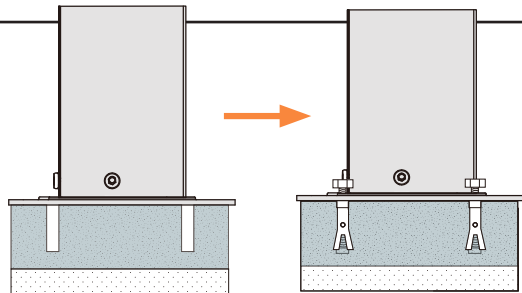

14# x 20



(included in package)

If the ground is concrete and the depth of it is over 3 inches, you can use 1/4 inch expansion bolts **14#** included in package to mount the gazebo.

3



Or you can make concrete footings for gazebo. **15 x 15 x 15 inches** is recommended. Using expansion bolts to mount the gazebo like (2) shows.



IMPORTANT:
Anchor is not recommended





CHECK LIST

Note: Please lay tarpaulin underneath all the parts to avoid scratching.

A × 4



A1 × 8



A2 × 8



B1 × 4

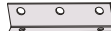

B × 2



C × 2



Ca × 2



Cb × 2



Cl × 2



Cl_a × 2



C2 × 2



C2_a × 2



D × 2



D1 × 2



E × 2



E1 × 2



F × 6



G × 4





H × 6



H2 × 1



K2 × 1

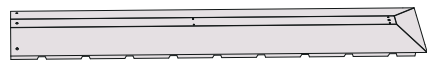

J1 × 4



L × 4



L1 × 2

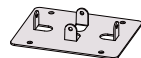

J2 × 4



M × 4



J3 × 5



M1 × 4



K × 2



N × 2



K1 × 1

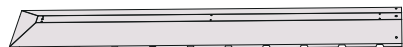

N1 × 4





N2×2



N3×4



P×2



P1×2

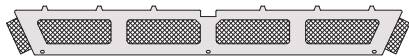

Q1×2



Q2×2



Q3×4



Q4×2

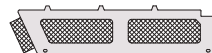

Q5×2

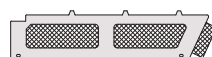

Q6×4

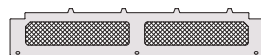

Q7×4

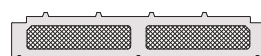

R×8



R1×6



S×192



S1×12



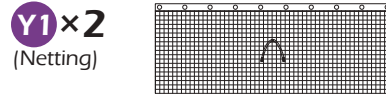
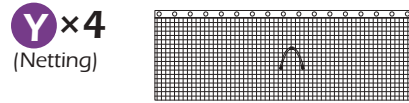



1#×313

(M6×16)



2#×36

(M6×20)



3#×16



4#×176

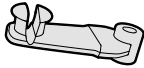

5#×120

(M6×28)



6#×64

(M6×50)



8#×40

(M5×16)



9#×28

(ST4.8×13)



10#×8

(M6×25)

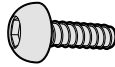

11#×16

(M6×10)

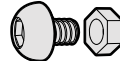

12#×5



13#×1



14#×20

(M6×70)



15#×7

(M6×16)

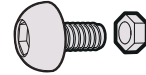

16#×1

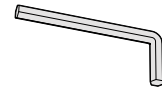

17#×1

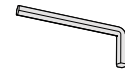

18#×1

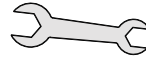

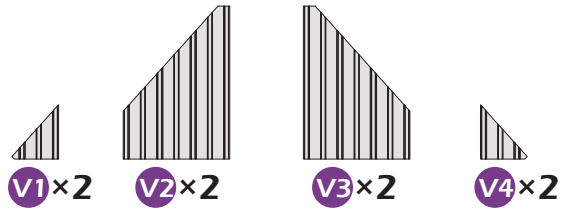

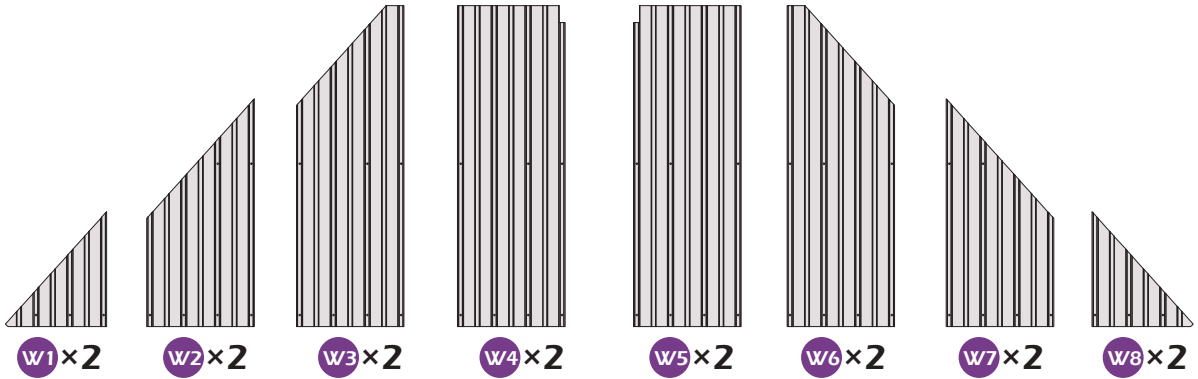

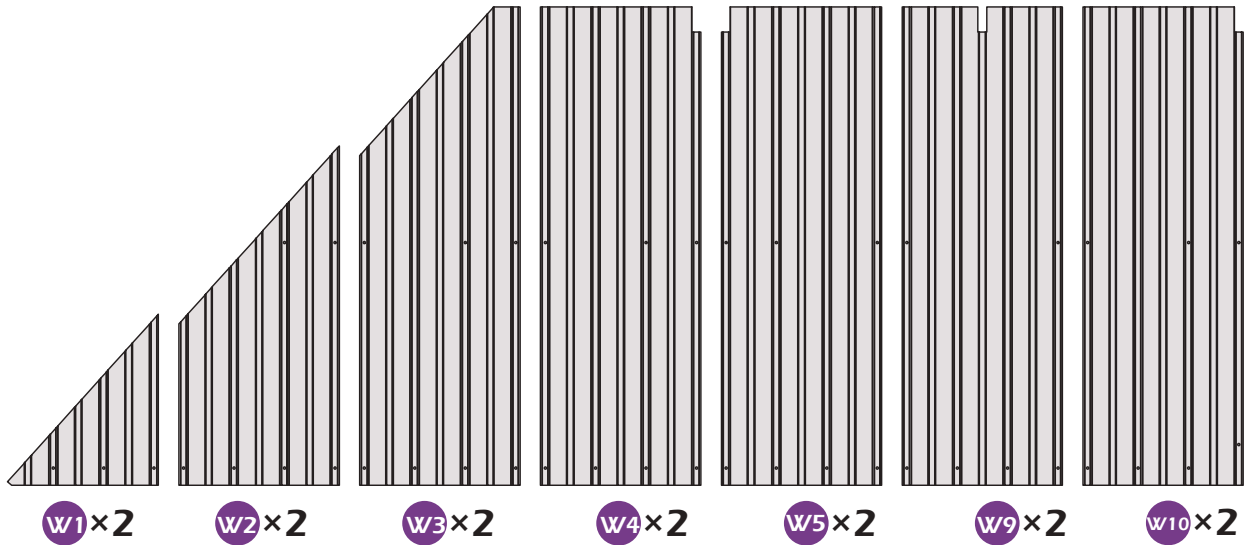

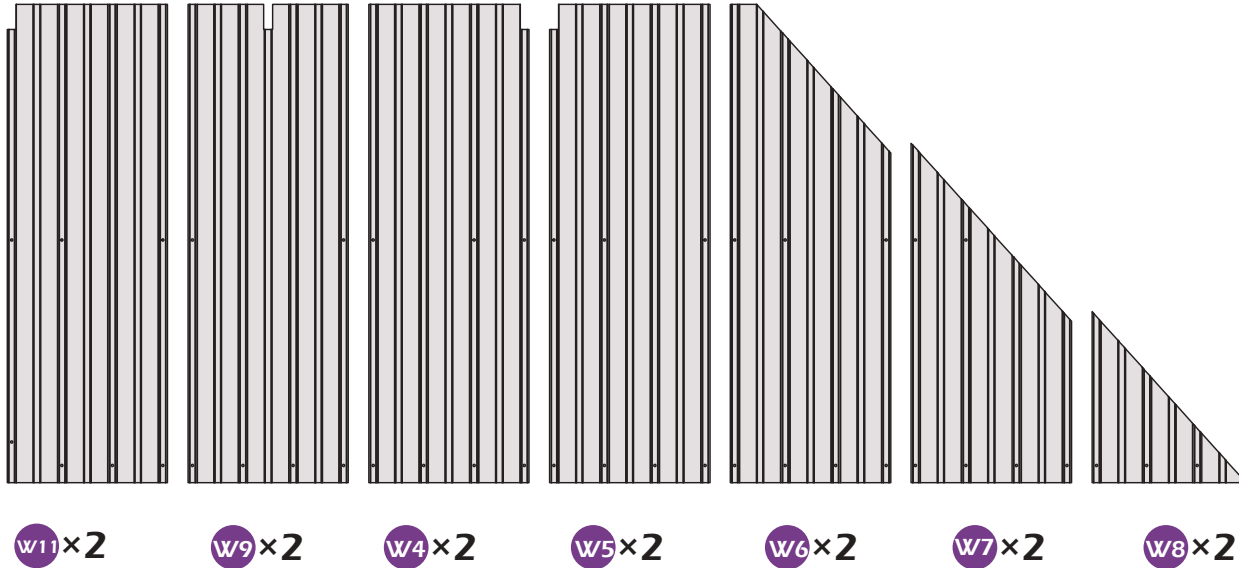

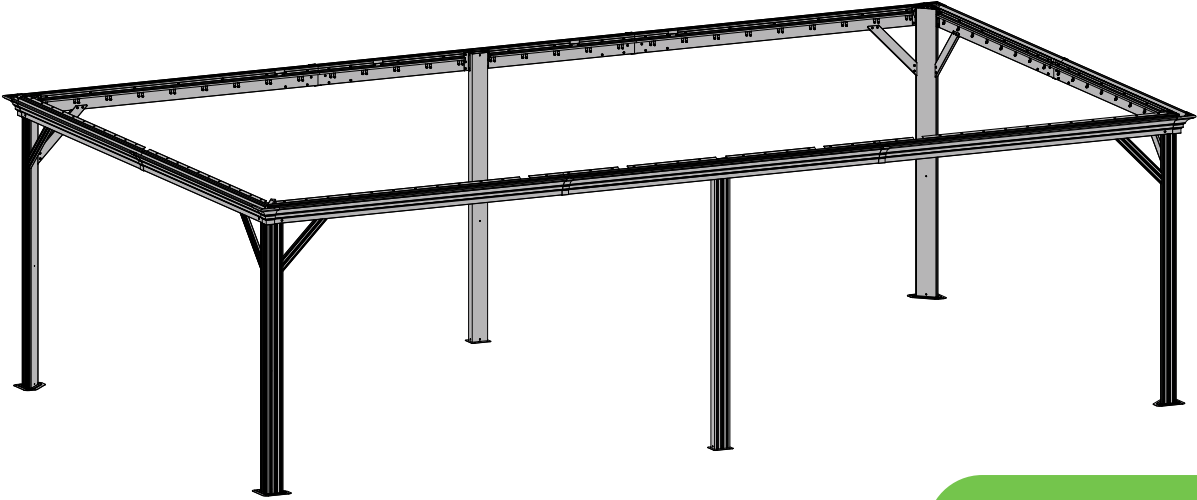

STEP 1



A × 4

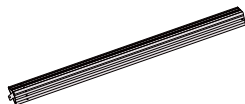

A1 × 8



A2 × 8



8# × 40

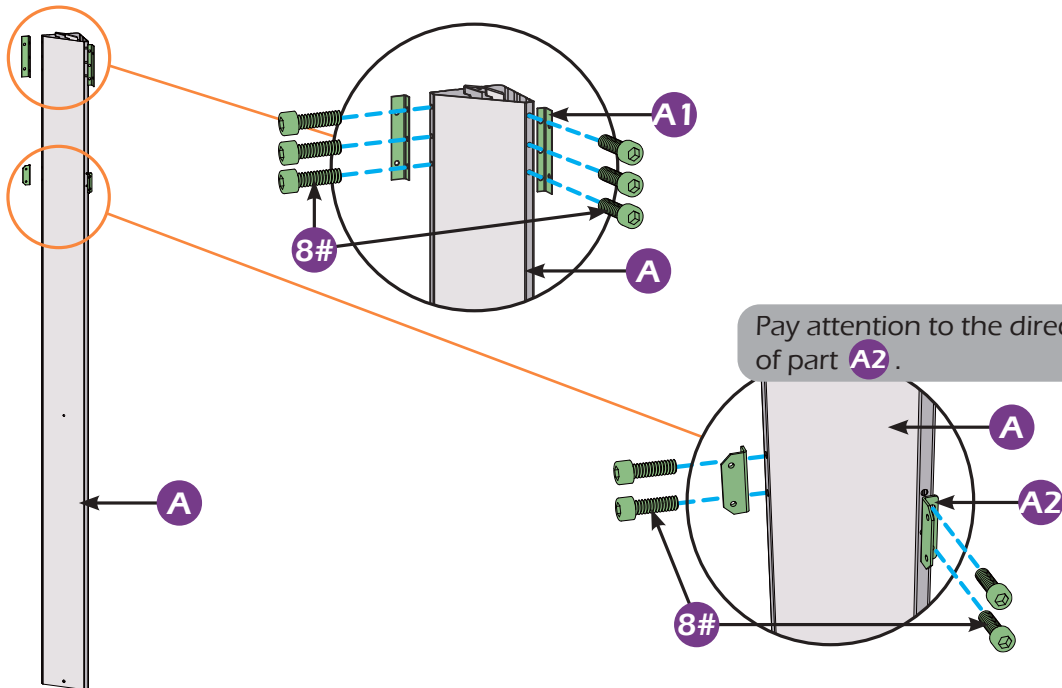

STEP 1

16



A × 4

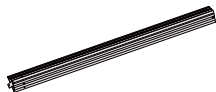

L × 4

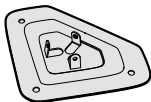

1# × 12

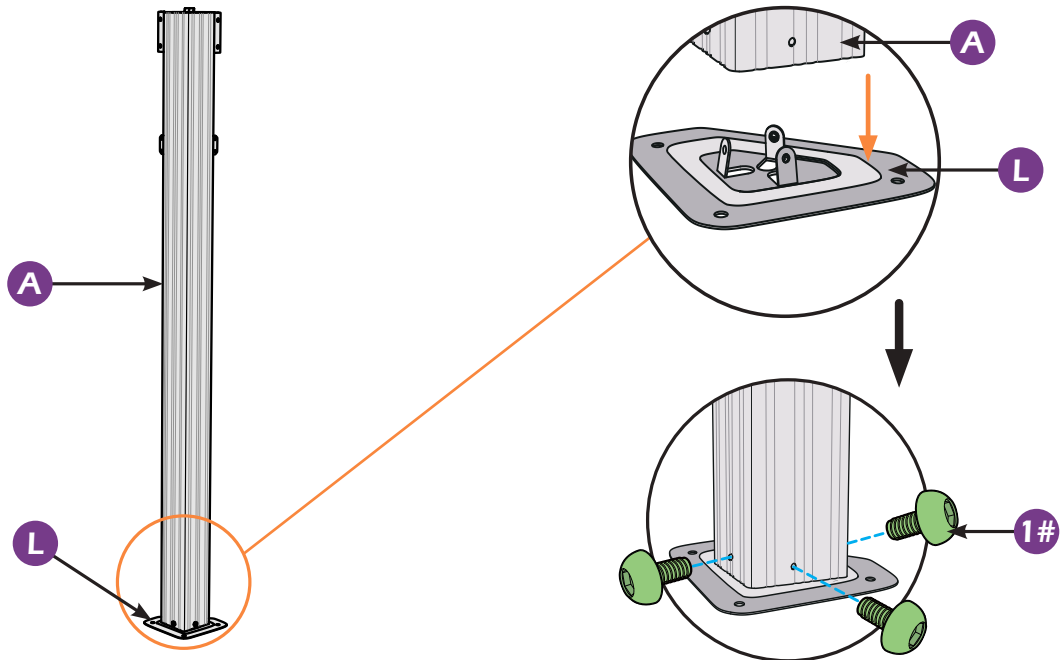
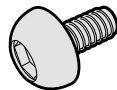

STEP 1



B×2



B1×4



1#×8

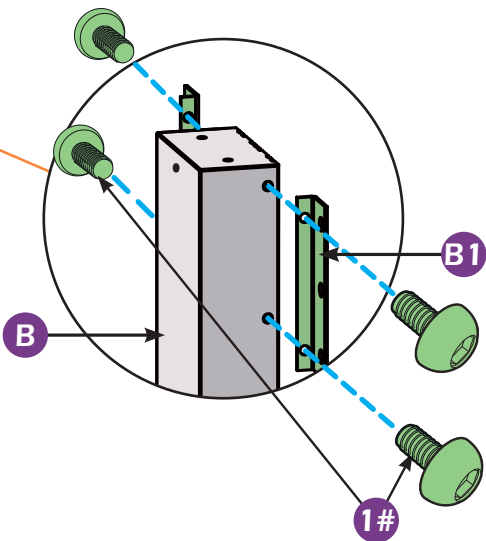
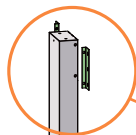



B × 2



L1 × 2

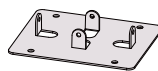

1# × 8

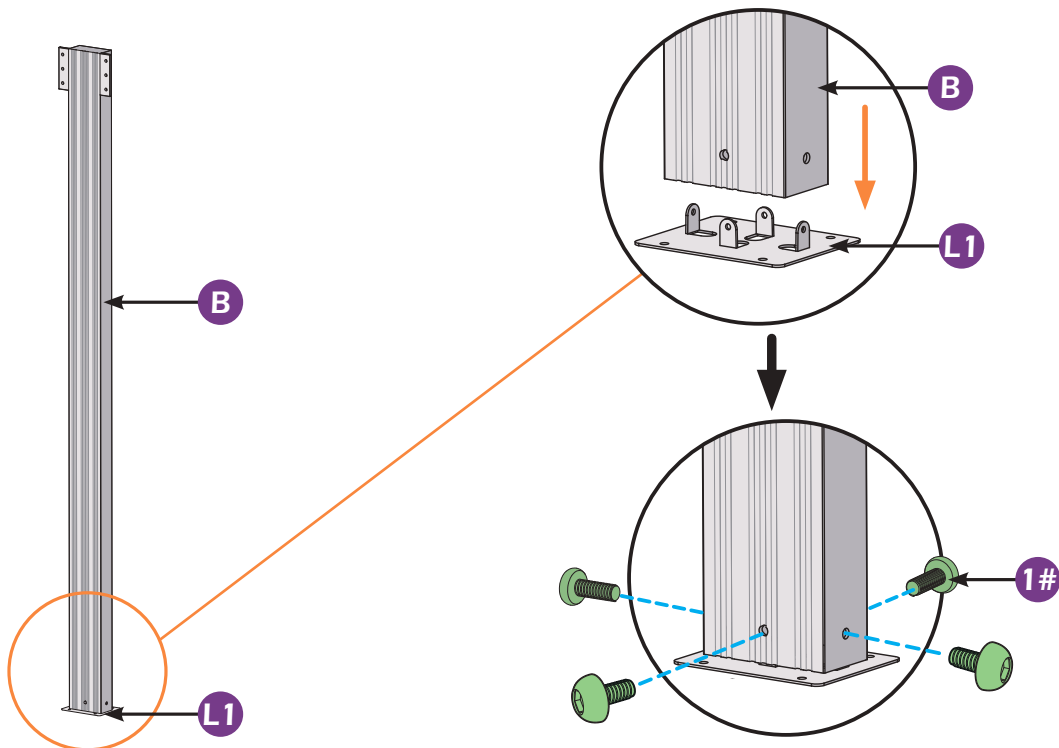



D × 2



F × 2

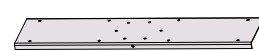

E × 2



1# × 12

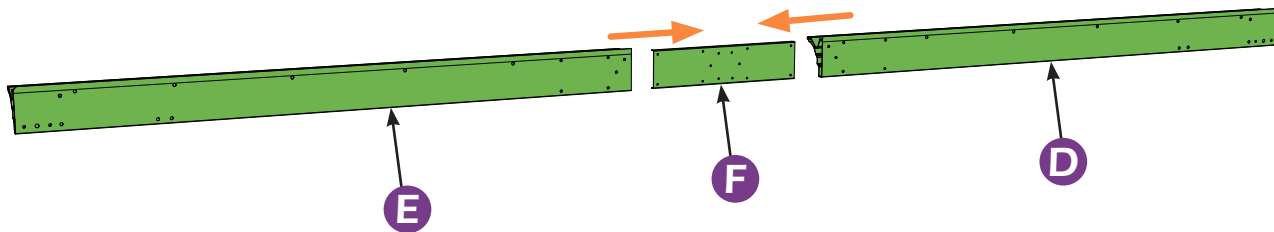

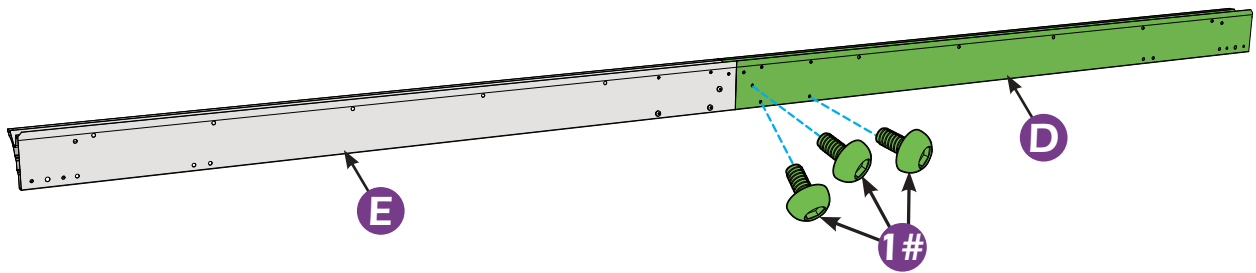
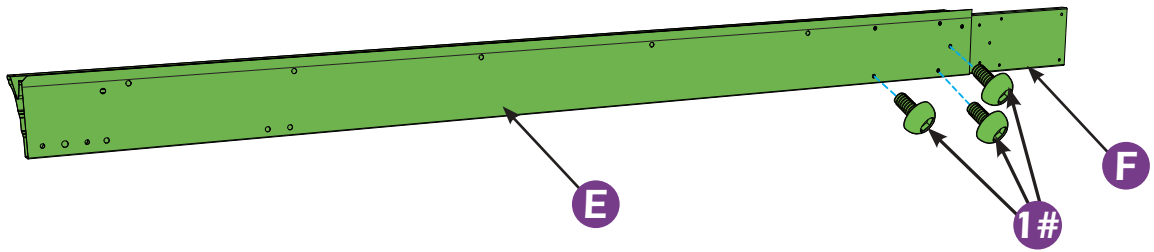

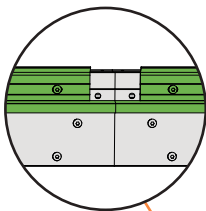

Note: Make sure that the interface between **D1** and **E1** is flush.

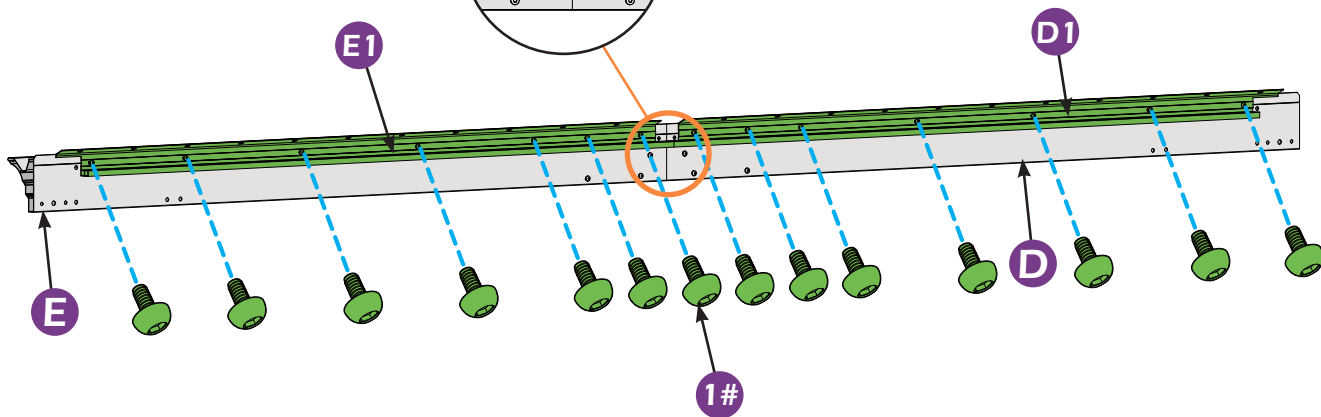



4#×64



Note: The curtain accessory is not included with this gazebo model. Should you wish to add this feature, please contact our Customer Service team to place an order. For your convenience, we have provided the required number of curtain hooks with your gazebo. We strongly recommend installing the hooks during the initial gazebo assembly, as installing them during curtain installation may prove challenging.

