

Features

- 118 BubbleMassage™ airjets.
- Blower motor with 300 W heater, grounding-type plug-in cord, and electronic user control.
- Pump with air switch, in-line heater, and grounding-type plug-in cord.
- Eight color-matched KOHLER hydro-massage jets.
- Slotted overflow for maximum bathing depth.
- Low threshold height.
- Molded lumbar support and armrests for comfort.
- 72" (1829 mm) x 36" (914 mm) x 19" (483 mm)

Material

- Acrylic

Installation

- Drop-in installation.

Required Accessories

K-7271 Slotted Overflow Bath Drain

or

K-7272 Slotted Overflow Bath Drain



ADA

Codes/Standards

ASME A112.19.7/CSA B45.10

CSA B45.5/IAPMO Z124

ASTM E162

ASTM E662

UL 1795

ADA











ICC/ANSI A117.1

KOHLER® One-Year Limited Warranty

See website for detailed warranty information.

Available Color/Finishes

Color tiles intended for reference only.

Color	Code	Description
	0	White
	96	Biscuit
	47	Almond
	NY	Dune
	95	Ice™ Grey
	G9	Sandbar
	33	Mexican Sand™
	K4	Cashmere
	58	Thunder™ Grey
	7	Black Black™

No change in measurements if connected with drain illustrated. (K-7272)

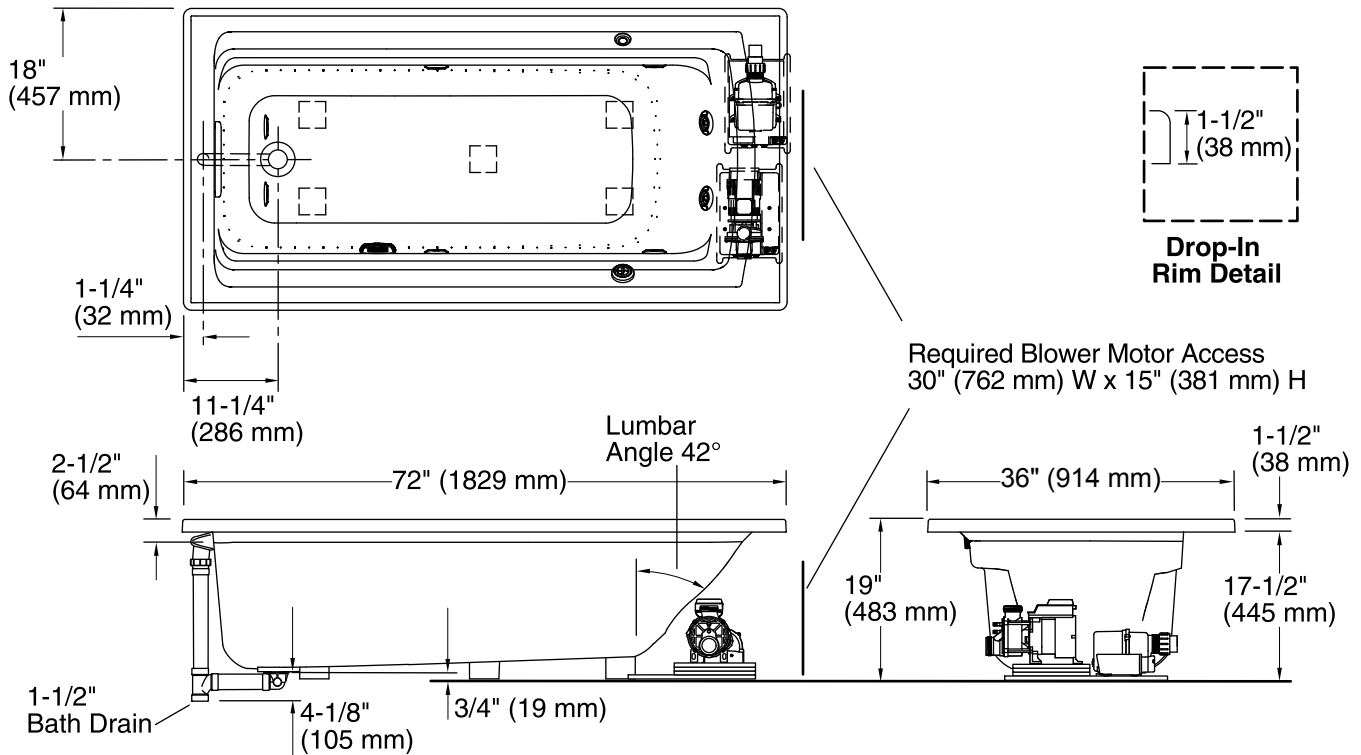

Required Electrical Service

Three dedicated circuits required, protected with Class A Ground-Fault Circuit-Interrupter (GFCI) or Residual Current Device (RCD).

Pump:	120 V, 15 A, 60 Hz
Heater:	120 V, 15 A, 60 Hz
Blower:	120 V, 15 A, 60 Hz

Technical Information

All product dimensions are nominal.

Installation:	Drop-in
Drain location:	Reversible
Basin area, bottom:	51-3/8" x 21" (1305 mm x 533 mm)
Basin area, top:	64-1/2" x 30-1/2" (1638 mm x 775 mm)
Weight:	140 lbs (63.5 kg)
Minimum floor load:	43 lbs/ft ² (209.9 kg/m ²)
Water depth:	15" (381 mm)
Water capacity:	72 gal (272.5 L)
Cutout:	Drop-in, 70-1/2" x 34-1/2" (1791 mm x 876 mm)

Notes

Measure your actual product for roughing-in details.

Install this product according to the installation guide. Product is designed for drop-in installation only. Product is not suited for three-wall alcove installations with overhead shower.

The hot water supply should be 70% of the capacity of the bath or greater. Installations will vary.

ADA compliant when installed to the specific requirements of these regulations.