

ASSEMBLY INSTRUCTIONS

IMPORTANT **PLEASE READ BEFORE YOU CONTINUE FURTHER**

ASSEMBLY PREPARATION

1. Remove all packaging materials, staples, and packing straps from the carton.
2. Refer to the Parts List and Hardware List to ensure all parts and hardware are correct before starting assembly.
3. Place all wooden parts on a clean, flat, and soft surface (e.g., carpet or rug) to prevent scratches and damage.

SAFETY PRECAUTIONS

1. KEEP ALL HARDWARE PARTS OUT OF REACH OF CHILDREN.
2. DISPOSE OF PLASTIC PACKAGING MATERIALS IMMEDIATELY TO AVOID ANY RISK OF SUFFOCATION TO CHILDREN AND ANIMALS.

TIPS FOR ASSEMBLY

1. Ensure ample space for assembly and position the area close to where the product will be placed.
2. Assemble the product on a surface that will not scratch or damage the exterior gloss or finishing of the furniture.
3. Identify all parts, hardware, and quantities required for each step.
4. Avoid over-tightening any fittings during assembly, as this may cause damage.
5. Use hand tools only--DO NOT USE POWER TOOLS TO ASSEMBLE THIS PRODUCT.
6. Always assemble the product on a flat, level surface.
7. Assembly requires two or more people--do not attempt to assemble the product alone, as there is a risk of injury.
8. Do not sit or stand on the partially assembled product. Use the product only for its intended purpose.

CARE AND MAINTENANCE

1. Clean with a soft, dry cloth. Avoid harsh chemicals or household cleaners, as they may damage the furniture's exterior finish.
2. Hardware may loosen over time. Regularly check all connections and re-tighten as needed.
3. Solid wood is sensitive to heat and humidity fluctuations, which can cause small joint separations or hairline cracks. To protect the furniture, keep it away from direct sunlight, air conditioning vents, heating vents, or units.
4. This product is intended for indoor and household use only, and is not suitable for commercial use.
5. If moving table, two people required to move it. Do not move it alone, and do not drag the table.





- DO NOT STAND ON THE TABLE
- DO NOT DRAG THE TABLE

Please make sure you have all these parts before you start.

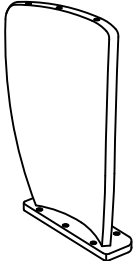
PART LIST

<p>Ⓐ x 1pc</p> 	<p>Ⓑ x 3pcs</p> 
--	---

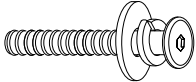
HARDWARE LIST

<p>① x (18pcs +1)</p>  <p>JCBC M6 x 40mm + S/W M6 + F/W M6 x 19mm</p>	<p>② x 1pc</p>  <p>ALLEN KEY M4 (BALL SHAPE)</p>	
--	---	--

(Extra Hardware for spare use)

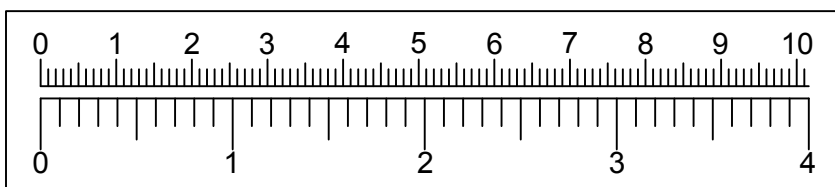

STEP 1

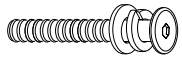
1	 JCBC M6 x 40mm + S/W M6 + F/W M6 x 19mm	18PCS
---	--	-------

Fully tighten bolts
but do not over tighten.

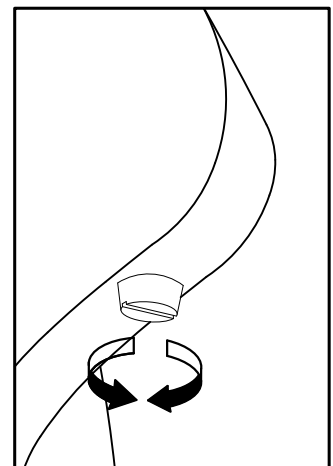
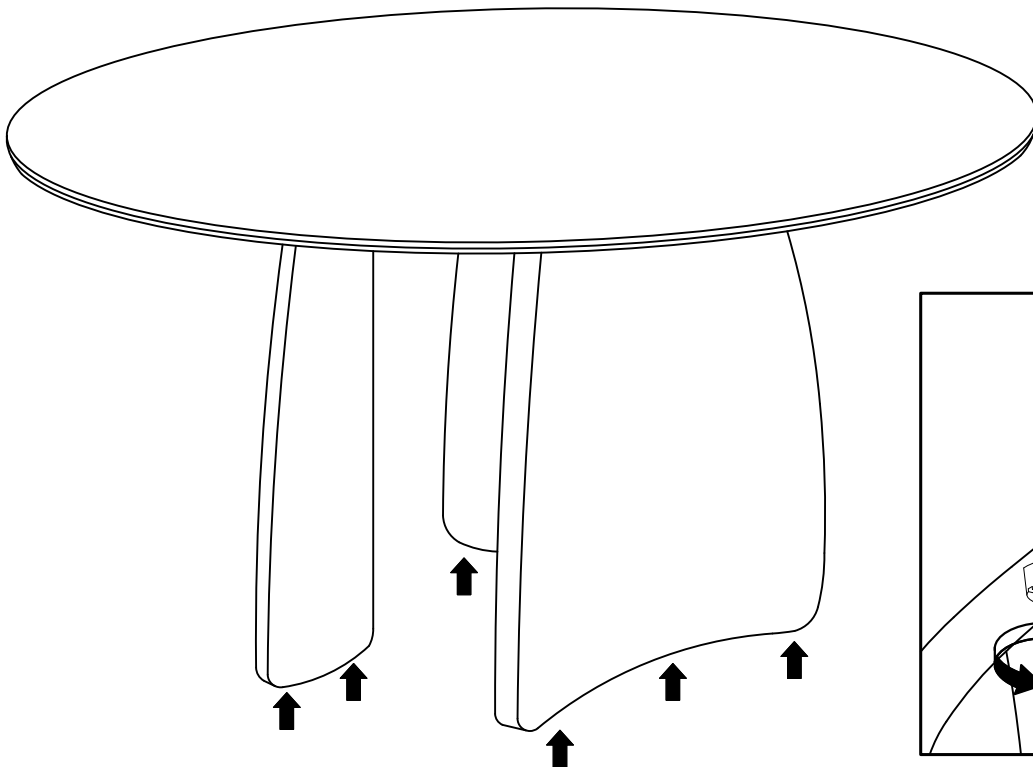
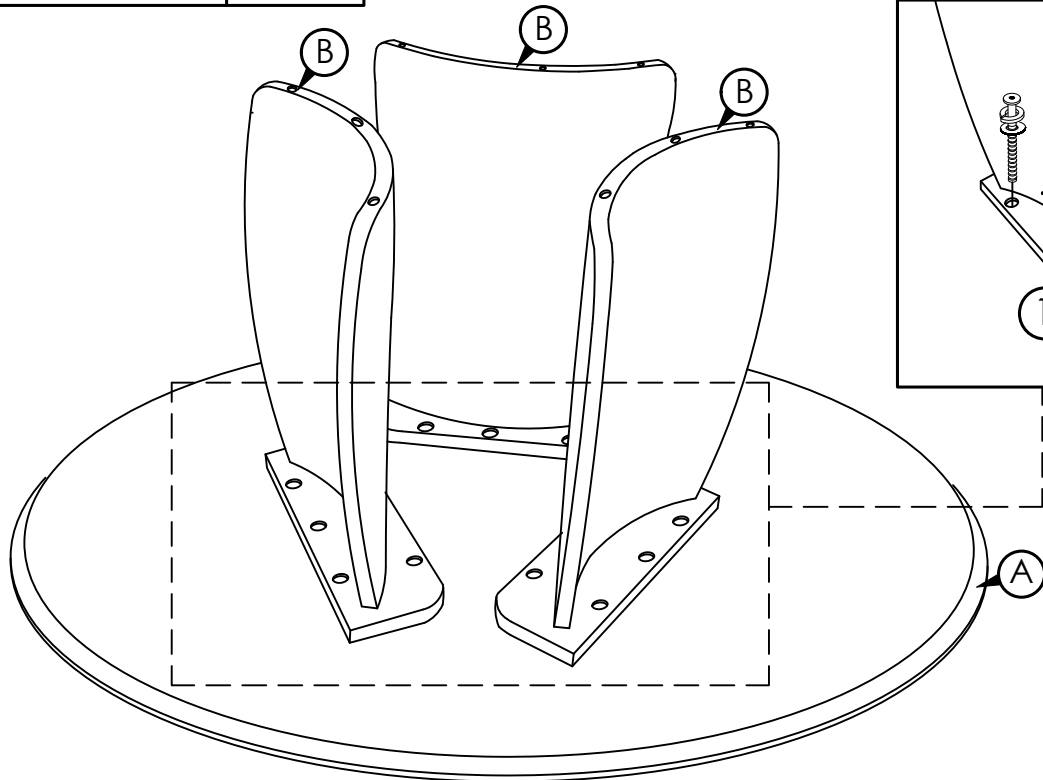

Turn clockwise or anti-clockwise
to adjust leg leveller.