

ASSEMBLY INSTRUCTIONS

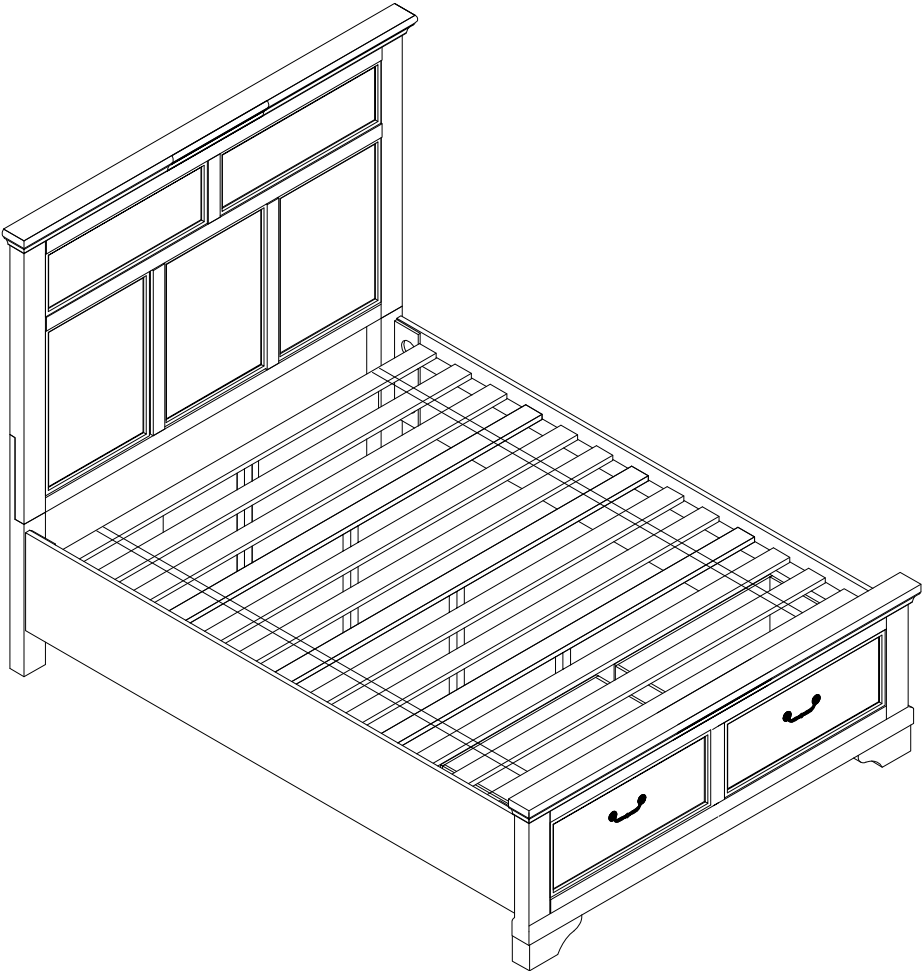

TOOLS REQUIRED



Screwdriver
(Not included)

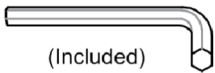

(Included)
Allen Wrench



2 - People

ASSEMBLY RATING



EASY ———> DIFFICULT

The Assembly Rating is a 5-point system showing the level of effort needed to assemble a specific product.



CHECK BEFORE STARTING

Are you missing anything?

Double-check all parts, hardware and accessories listed are all accounted for.

Check out our Quick Tips!

We recommend reviewing the pre-assembly handouts. Even experts need a refresher now and then!

Should we send any replacements?

Are there any irregularities or flaws in the parts? We can send replacements!

Prep Time!

Please review the assembly instructions and all diagrams prior to assembling.

PRE ASSEMBLY INTRODUCTION

We understand building ready-to-assemble furniture can be a challenging experience for some. To help avoid confusion, we have provided some helpful tips that may speed up the process.



Teamwork

ALWAYS have at least two people to help with transporting and assembling the product to avoid potential injury and/or damage.



Suitable Location

Assembling near the area of the intended location is highly recommended.



Sufficient Space

Make sure you have enough space to move around during the assembly.



Avoid Scratches

Use cardboard, blankets or a carpeted area while assembling furniture to prevent to prevent scratches and damages.



Flat Surface

Make sure the furniture rests on a flat and level surface with each leg evenly touching the floor.

ASSEMBLY AND CARE ADVICE



FAILURE TO FOLLOW THE GUIDELINES BELOW MAY RESULT IN INJURY AND/OR PROPERTY DAMAGE.



Position each part correctly and insert screws or bolts into their respective holes.

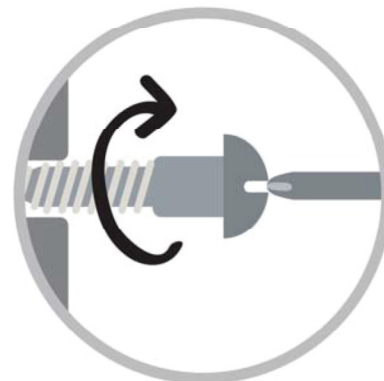

Turn clockwise to tighten and only tighten when step is completed or when instructed to do so.



Use the appropriate hand tools or power tools for assembly. Select steps, such as tightening screws and/or bolts, may require hand tools to avoid causing damage during assembly.



Save the instructions and store any supplied tools for later maintenance.



After two weeks, check and tighten any loose hardware and repeat again every six months thereafter.

IT IS THE USER'S RESPONSIBILITY TO MAINTAIN THE FURNITURE. THE HARDWARE MAY LOOSEN OVER TIME AND MAY CAUSE THE FURNITURE TO BE WOBBLY AND UNABLE TO SUPPORT ITS INTENDED WEIGHT CAPACITY. THIS MAY LEAD TO COLLAPSE AND MAY CAUSE SERIOUS INJURY.

QUEEN BED

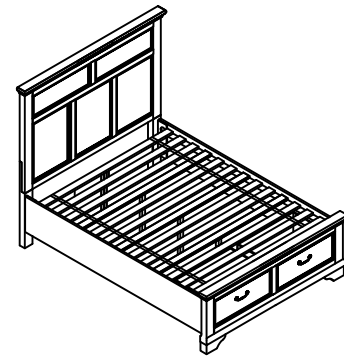
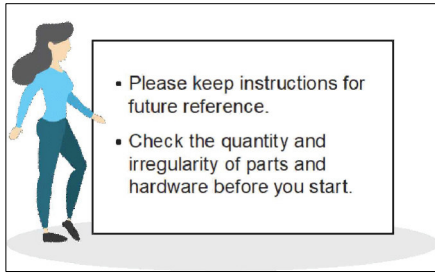

PARTS

①

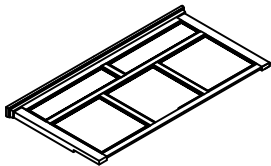

HEADBOARD
1pc

②

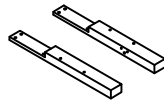

HEADBOARD LEG L/R
2pcs

③

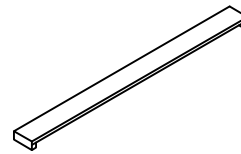

STRETCHER
1pc

④

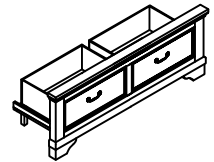

FOOTBOARD
1pc

⑤

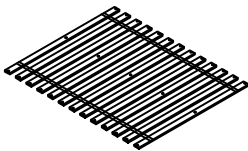

SLATS ROLL
13pcs

⑥

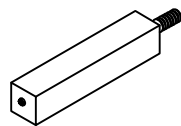

SUPPORT SLATS
4pcs

⑦

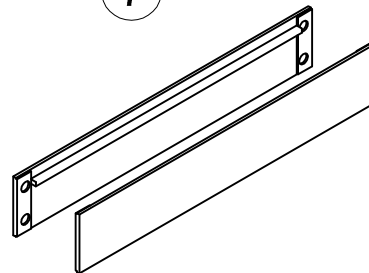

SIDE RAILS
2pcs

HARDWARE

1 .ASSEMBLY HEABOARD

A



ALLEN WRENCH
1pc

B



BOLT $\text{\O}5/16"$ x 2"
10pcs

C



LOCK WASHER $\text{\O} 5/16$
10pcs

D



LOCK WASHER $\text{\O} 5/16$ x 19mm
10pcs

2 .ASSEMBLY SIDE RAILS

E

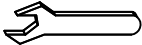

OPEN WRENCH
1pc

F



NUTS $\text{\O}5/16"$
8pcs

G



CURVED WASHER
8pcs

H



BOLT $\text{\O}5/16"$ x 3"
8pcs



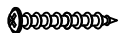





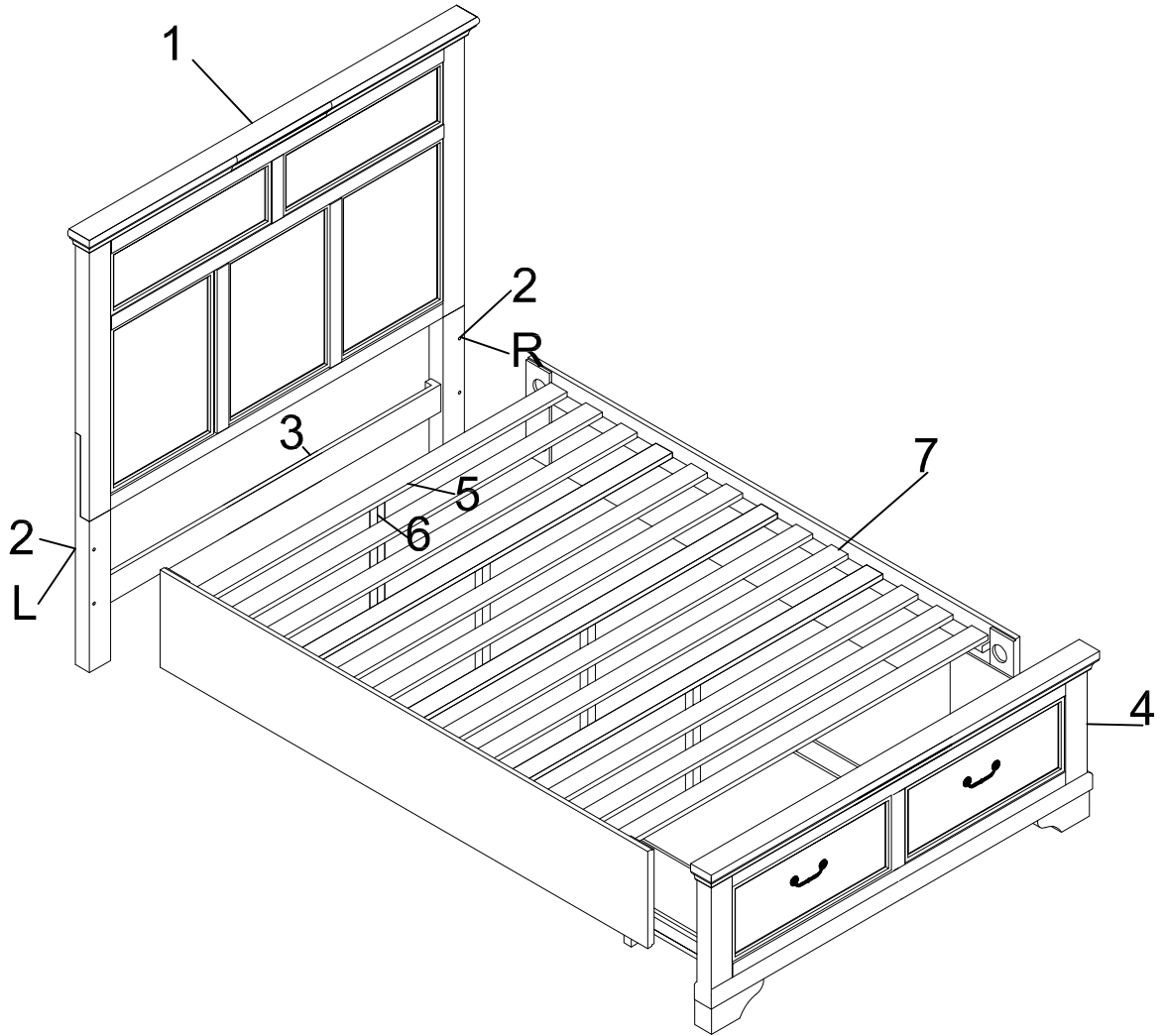

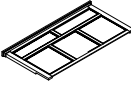
I

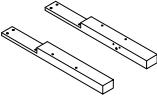
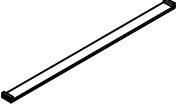
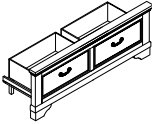
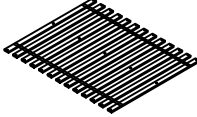
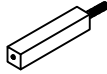
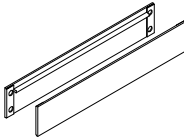

WOOD SCREWS $\text{\O}8$ *1 1/4"
26pcs

EXPLODED VIEW



Carton	Disignation	Part	Part	Hardware
	Headboard	# 1		 # A x 1pc  # B x 10pcs  # C x 10pcs  # D x 10pcs
	Headboard legs L/R	# 2		
	Stretcher	# 3		
	Footboard	# 4		
	Slats	# 5		
	Support Slats	# 6		
	Side rails	# 7		 #E x 1pc  # F x 8pcs  #G x 8pcs  # H x 8pcs  # I x 26pcs

ASSEMBLY INSTRUCTIONS

- 1** Part #1 x 1pc
Part #2 x 2pcs
Hardware #A x 1pc
Hardware #B x 8pcs
Hardware #C x 8pcs
Hardware #D x 8pcs

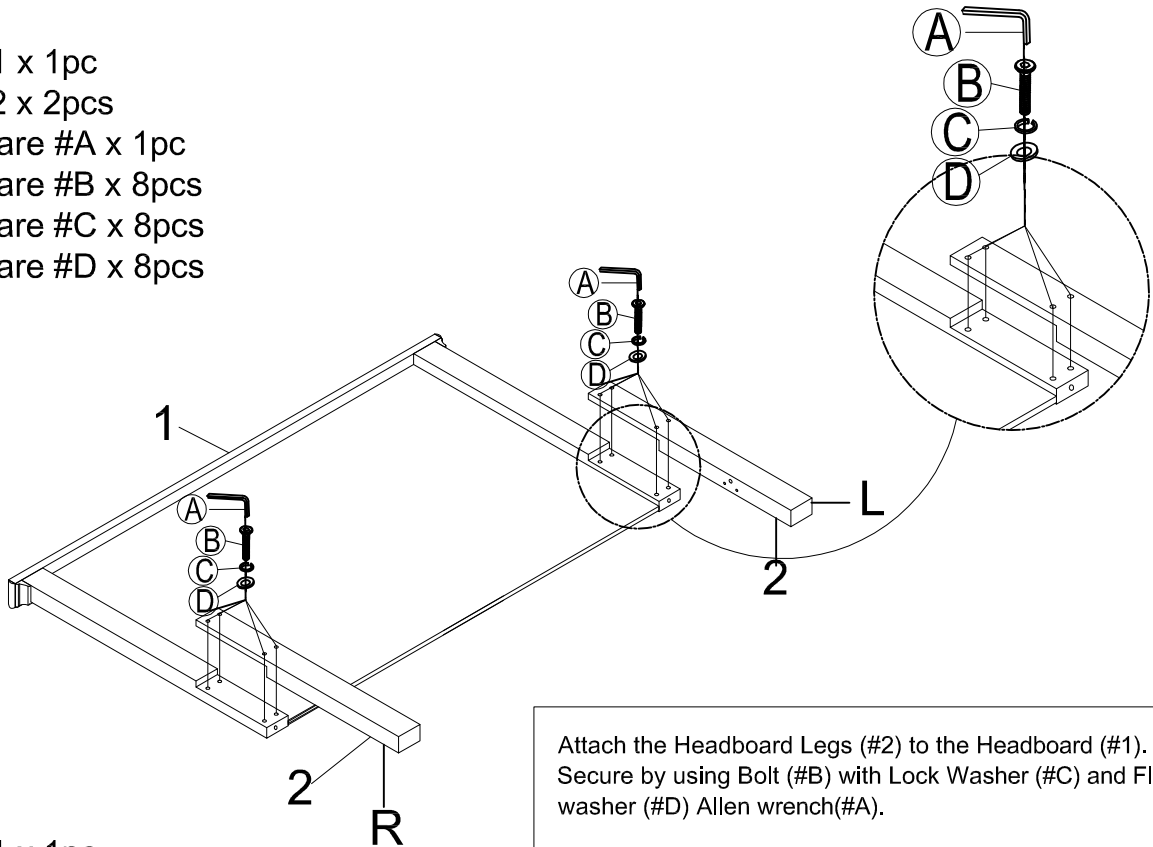

Attach the Headboard Legs (#2) to the Headboard (#1). Secure by using Bolt (#B) with Lock Washer (#C) and Flat washer (#D) Allen wrench(#A).

- 2** Part #1 x 1pc
Part #2 x 2pcs
Part #3 x 1pc
Hardware #A x 1pc
Hardware #B x 2pcs
Hardware #C x 2pcs
Hardware #D x 2pcs

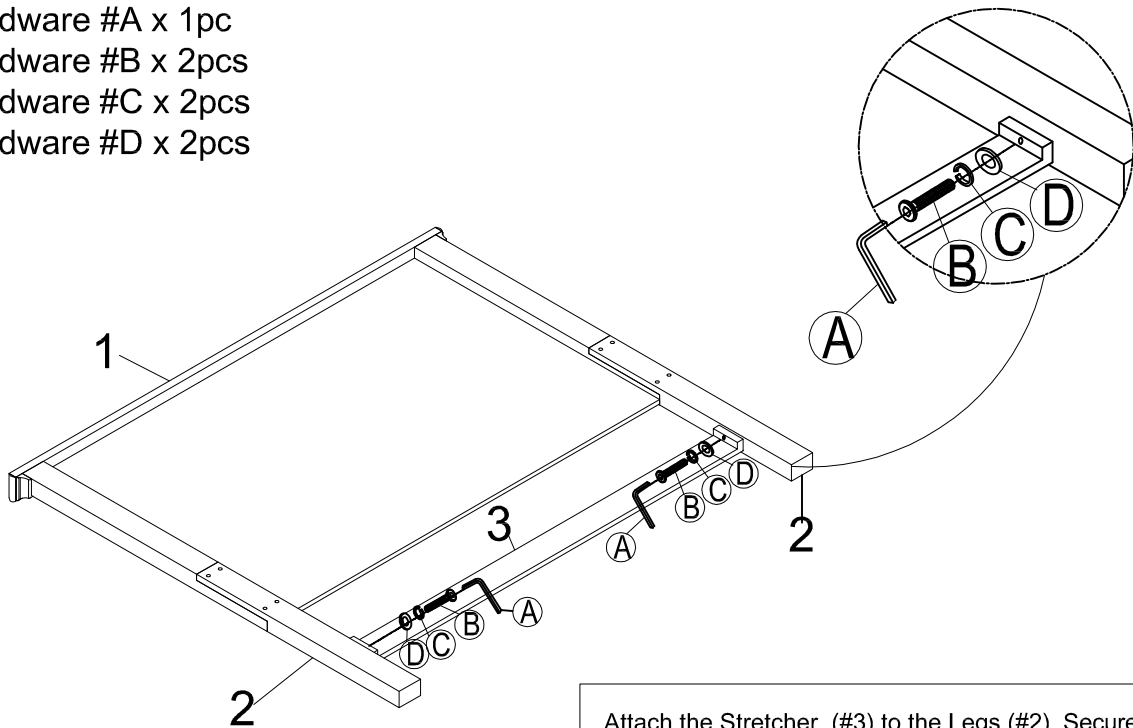

Attach the Stretcher (#3) to the Legs (#2). Secure by using Bolt (#B) with Lock Washer (#C) and Flat washer (#D) Allen wrench(#A).

ASSEMBLY INSTRUCTIONS

3

Headboard x 1pc
Footboard x 1pc
Part #7 x 2pcs
Hardware #E x 1pc
Hardware #F x 8pcs
Hardware #G x 8pcs
Hardware #H x 8pcs

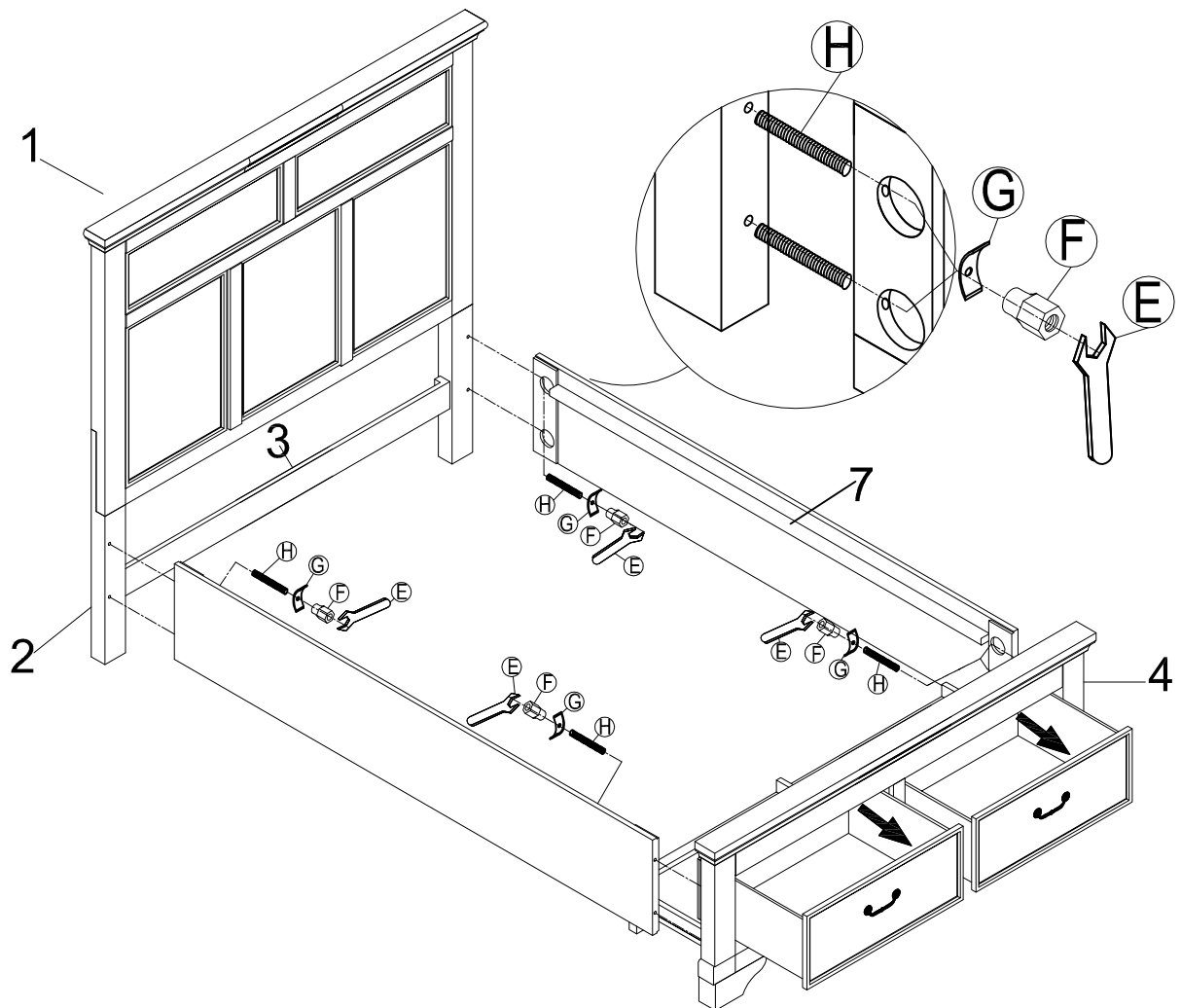

Screw the Bolt (H) into HB & FB.
Align the bolts with the holes in the end of side rails and attach the side rails to HB & FB using half moon washers (G) and nuts (F). Then use a hex wrench (E) to tighten all the nuts.

ASSEMBLY INSTRUCTIONS

- 4** Headboard x 1pc
Footboard x 1pc
Part #5 x 13pcs
Part #6 x 4pcs
Part #7 x 2pcs
Hardware # 1 x 26pcs

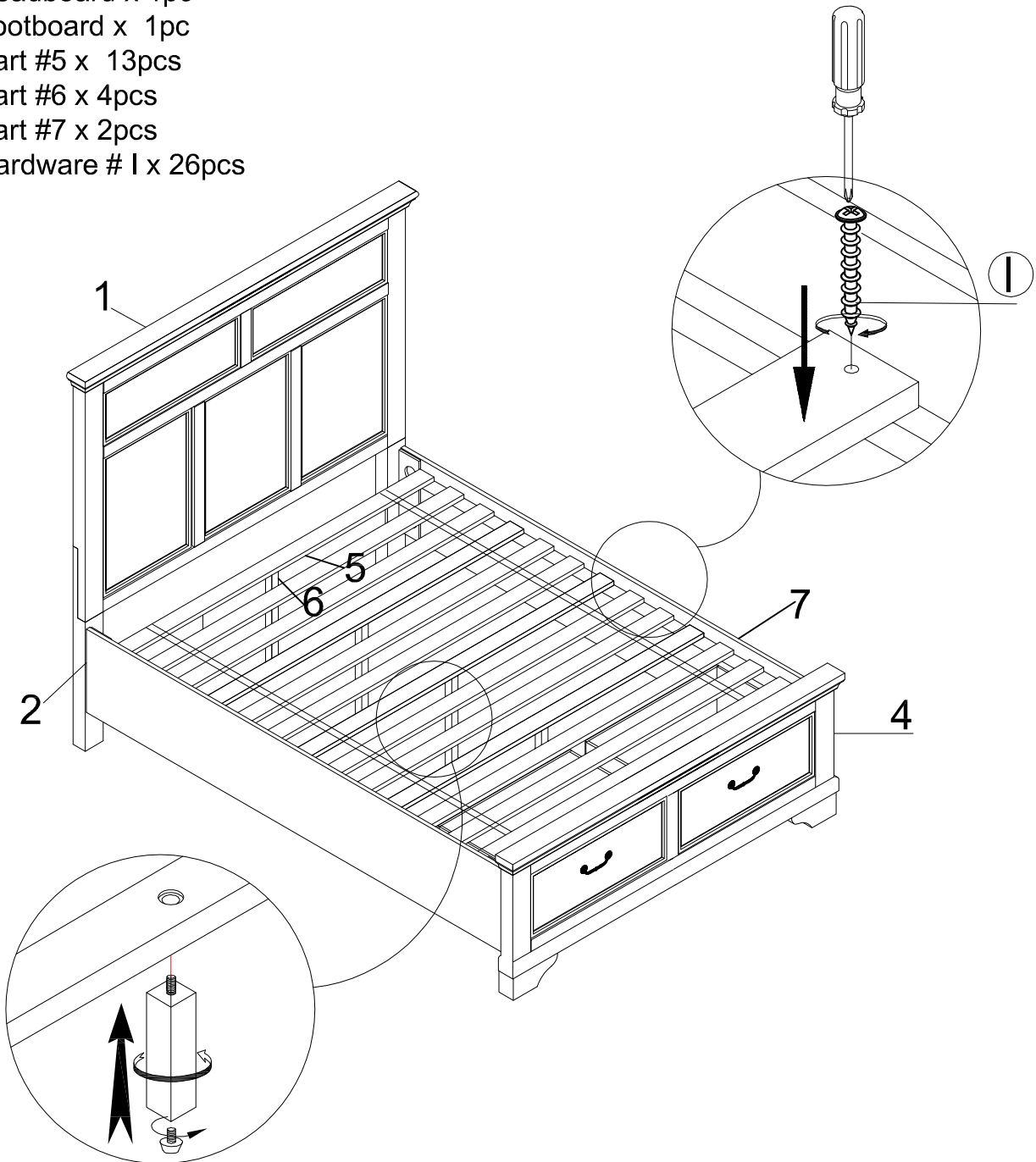

ASSEMBLY INSTRUCTIONS

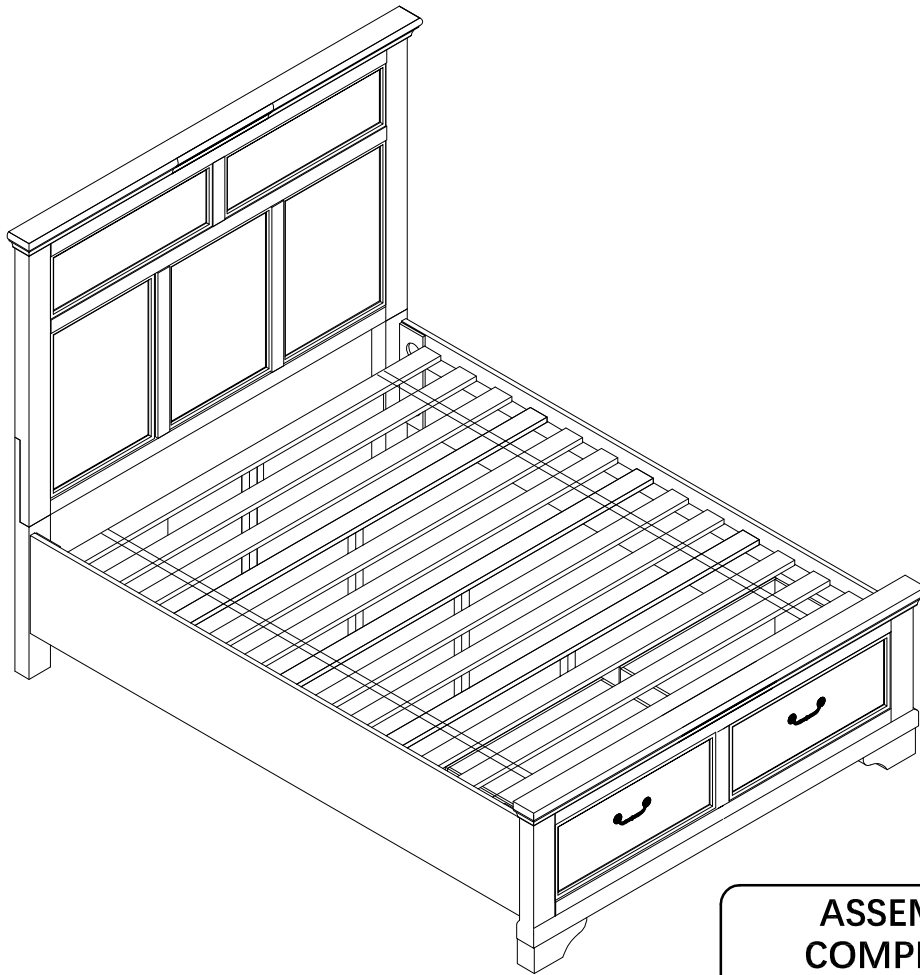

ASSEMBLY COMPLETED



Please ensure the Furniture rests on an even and flat surface. If the product wobbles or feels loose, double-check all bolts and/or screws are properly tightened and secured.



Keep this handy!

Please retain this instruction manual and any order-related information for future reference.



Lift, don't drag!

To avoid damage to product please always LIFT the product when transporting or adjusting the placement