

## NOTICE

- \* Please make sure that you have all parts indicated and they are in good condition before you begin assembly of this item. Refer to part list and hardware list below for guidance.
- \* This item should be assembled on a soft surface to prevent scratching the finish during assembly.
- \* This item may require periodic tightening.
- \* If you are having difficulty, our friendly Customer Care team is always here to help. Please Email [customersupport@safavieh.com](mailto:customersupport@safavieh.com)

## PREPARATION

- \* Before beginning assembly of product, make sure all parts are present. Compare parts with part contents list and hardware contents list.
- \* If any part is missing or damaged, do not attempt to assemble the product.
- \* Estimated Assembly Time: 10 minutes.
- \* Tools Required for Assembly (included): Allen Key

## CARE AND MAINTENANCE

**WOOD CARE:** Adhesive felt pads should always be applied to areas of furniture which make direct contact with flooring, said application will prevent damage to the furniture and or surfaces on which the furniture lies. Objects placed on articles of furniture should rest on nonabrasive material as to prevent damage to the wood finish. Wipe up spills immediately and avoid common hazards such as hot dishes, harsh solvents and abrasives. Cleaning should be done with a soft lint free cotton cloth dampened with water or furniture polish.

**UPHOLSTERY CARE:** To prevent overall soiling, frequent vacuuming or light brushing is recommended. Cushions and pillows should be turned on a weekly basis. Down-filled cushions should be brushed rather than vacuumed. Spot clean, using a mild water-free solvent or dry cleaning product. Only a professional cleaner should undertake a complete overall cleaning. The use of steam or water-based cleaners may cause excessive shrinking or staining.



**ITEM ID:** BST5603











**ITEM DIMENSION:** 20 1/2" x 19 3/4" x 43"



### ⚠ WARNING ⚠

Weight Capacity - 225 LBS  
Warning : Do not stand on chair  
Warning : Do not over torque bolts.

## Part List and Hardware List

PIECE	DISCRIPTION	PICTURE	QTY	PIECE	DISCRIPTION	PICTURE	QTY	PIECE	DISCRIPTION	PICTURE	QTY
A	Bottom Frame		1x	HW1	Socket Bolts M6x1.0x25mm		4x	HW6	Allen Key M4		1x
B	Chair Leg		4x	HW2	Socket Bolts M6x1.0x35mm		10x				
C	Leg Support		1X	HW3	Socket Bolts M6x1.0x45mm		4x				
D	Top Frame Cushion		1x	HW4	Split Lock Washer 6mm		18x				
E	Back Rest		1x	HW5	Flat Washer 6mm		8x				

### PREPARATION

- \* Before beginning assembly of product, make sure all parts are present. Compare parts with part contents list and hardware contents list.
- \* If any part is missing or damaged, do not attempt to assemble the product.
- \* Estimated Assembly Time: 10 minutes.
- \* Tools Required for Assembly (included): Allen Key

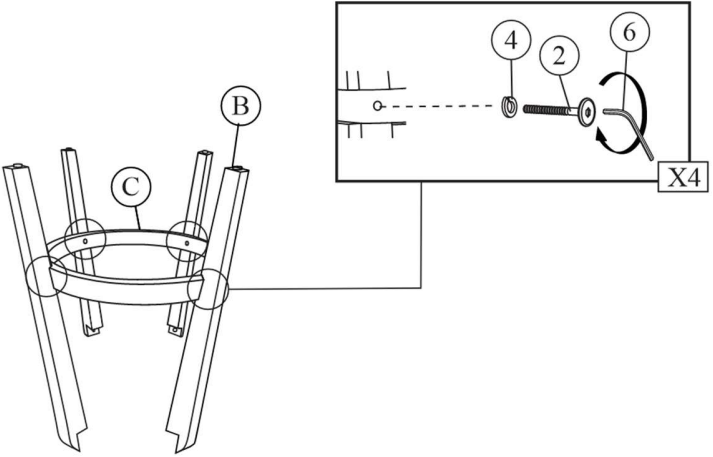
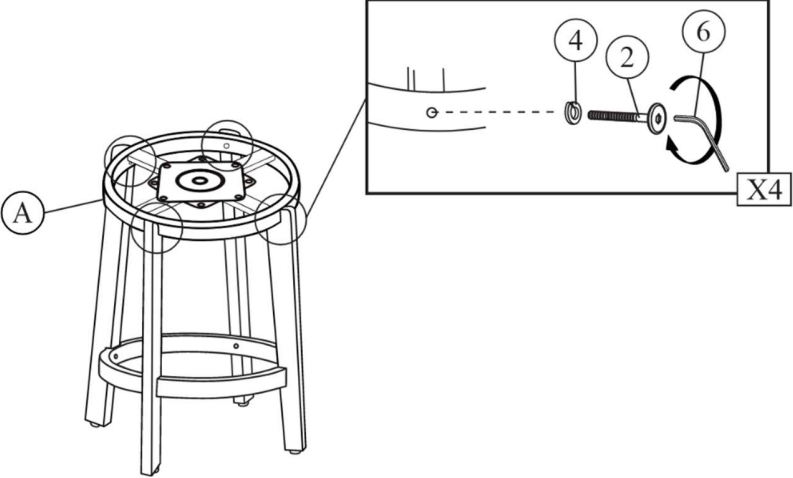
	
<p><b>Step 1:</b> Take the Chair Leg (B) and attach them to the Leg Support (C), using the Socket Bolts (HW2) and Split Lock Washer (HW4). Use the Allen Key (HW6) to tighten. Do not fully tighten the bolts yet.</p>	<p><b>Step 2:</b> Attach the Bottom Frame (A) to the Chair Leg (B), using the Socket Bolts (HW2) and Split Lock Washer (HW4). Use the Allen Key (HW6) to tighten. Make sure all four legs are balance and do not fully tighten the bolts yet.</p>

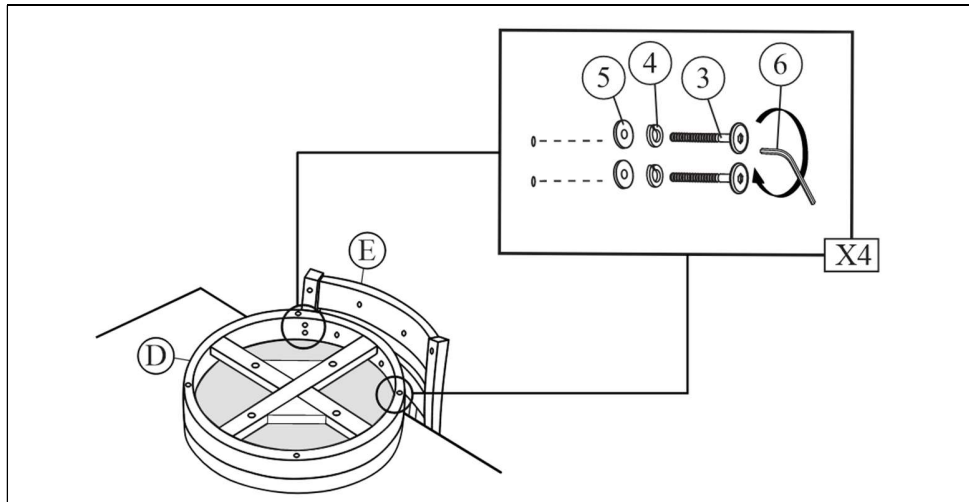

**Step 3: Attach the Top Frame Cushion (D) to the Back Rest (E), using the Socket Bolts (HW3), Split Lock Washer (HW4) and Flat Washer (HW5). Use the Allen Key (HW6) to tighten. Do not fully tighten the bolts yet.**

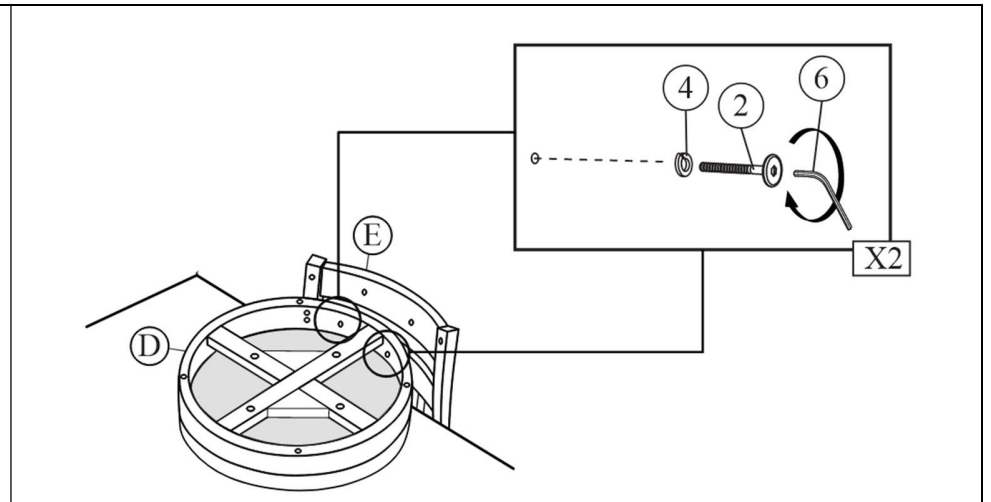

**Step 4: Further secure the Top Frame Cushion (D) to the Back Rest (E), using the Socket Bolts (HW2) and Split lock Washer (HW4). Use the Allen Key (HW6) to tighten. Do not fully tighten the bolts yet.**

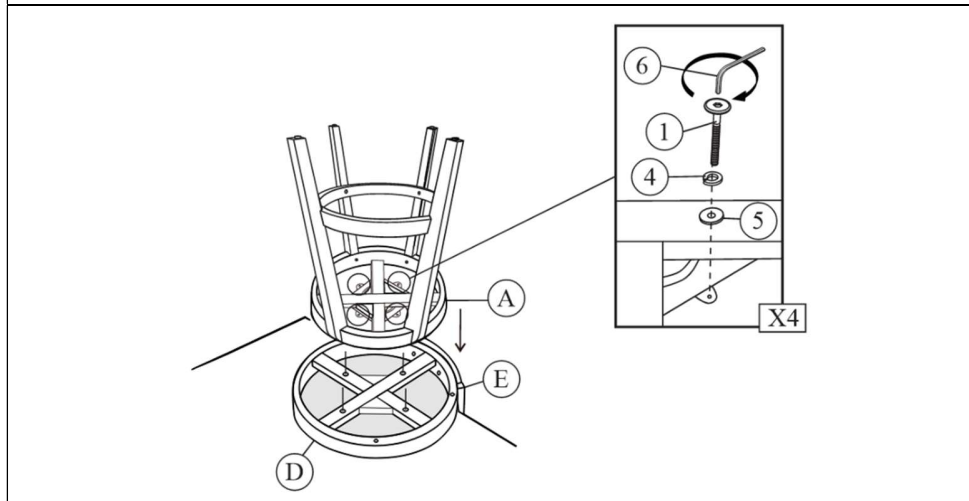

**Step 5: Attach the Bottom Frame (A) to the Top Frame Cushion (D), using the Socket Bolts (HW1), Split Lock Washer (HW4), Flat Washer (HW5). Using the Allen Key (HW6) to tighten all the bolts.**

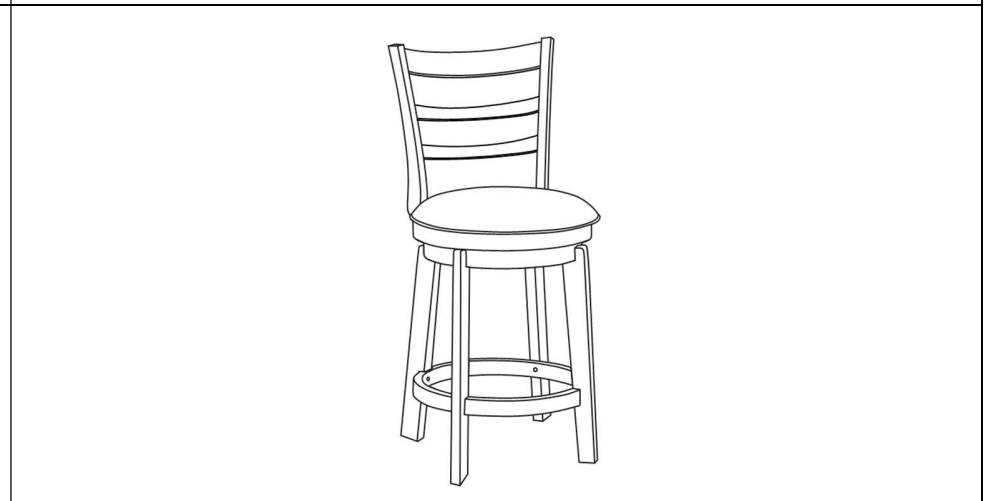

**Step 6: Assembly complete. Enjoy your counter stool!**