

ASSEMBLY INSTRUCTIONS

WF306079/080/083

2 SEATER SOFA

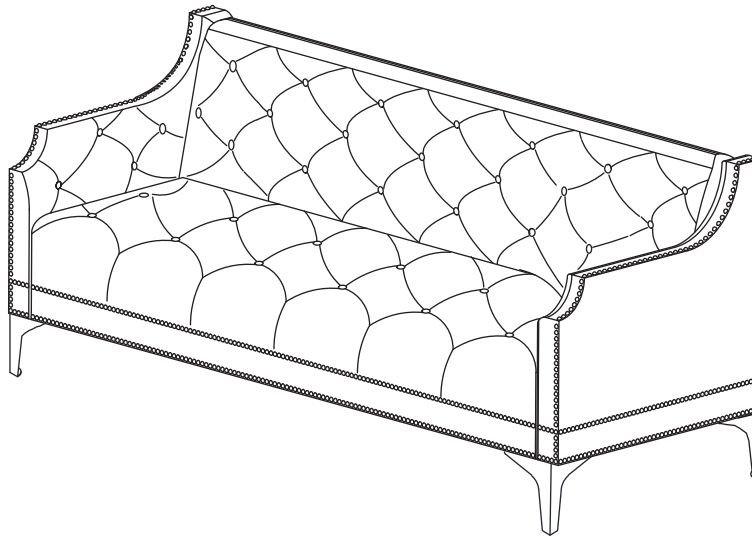

2 SEATER SOFA is packed in 3 cases

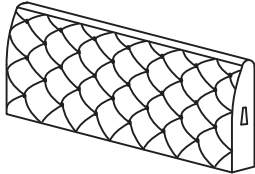
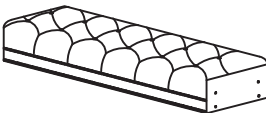
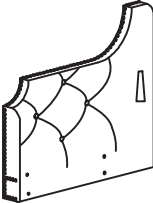
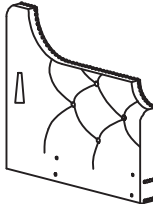
Carton	Disignation	Part	Hardware/Leg
1/3 WF306079	Backrest	#1 	
2/3 WF306080	Seat	#2 	<div style="display: flex; flex-wrap: wrap; gap: 5px;"> <div style="border: 1px solid black; border-radius: 50%; padding: 2px;">#A</div> <div style="border: 1px solid black; border-radius: 50%; padding: 2px;">#B</div> <div style="border: 1px solid black; border-radius: 50%; padding: 2px;">#C</div> <div style="border: 1px solid black; border-radius: 50%; padding: 2px;">#D</div> <div style="border: 1px solid black; border-radius: 50%; padding: 2px;">#E</div> <div style="border: 1px solid black; border-radius: 50%; padding: 2px;">#F</div> <div style="border: 1px solid black; border-radius: 50%; padding: 2px;">#G</div> <div style="border: 1px solid black; border-radius: 50%; padding: 2px;">#H</div> <div style="border: 1px solid black; border-radius: 50%; padding: 2px;">#I</div> </div>
3/3 WF306083	Left arm	#3 	
	Right arm	#4 	

ASSEMBLY INSTRUCTIONS

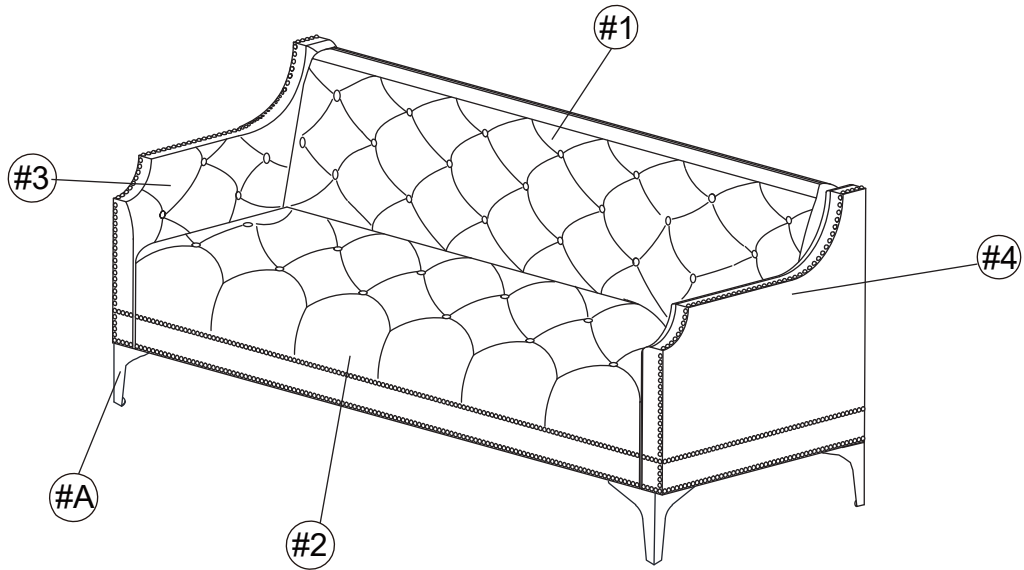

PARTS

#1 1pc

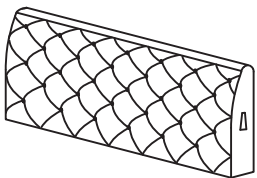

BACKREST

#2 1pc

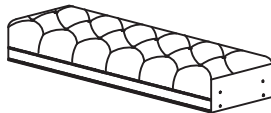

SEAT

#3 1pc

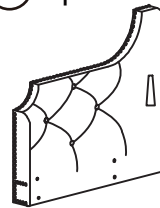

LEFT ARM

#4 1pc

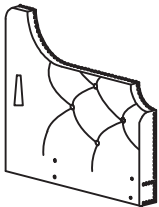

RIGHT ARM

HARDWARE/LEG

#A 4 pcs

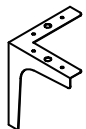

LEG

#B 8 pcs



WHOLE TOOTH SCREW
90mm L

#C 8 pcs



NUT

#D 8 pcs



FLAT WASHER
22mm

#E 1 pc

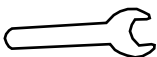

WRENCH

#F 8 pcs



BOLT 25MM L

#G 8 pcs



SPRING WASHER

#H 8 pcs



FLAT WASHER
16mm

#I 1 pc



ALLEN KEY

ASSEMBLY INSTRUCTIONS

STEP 1:

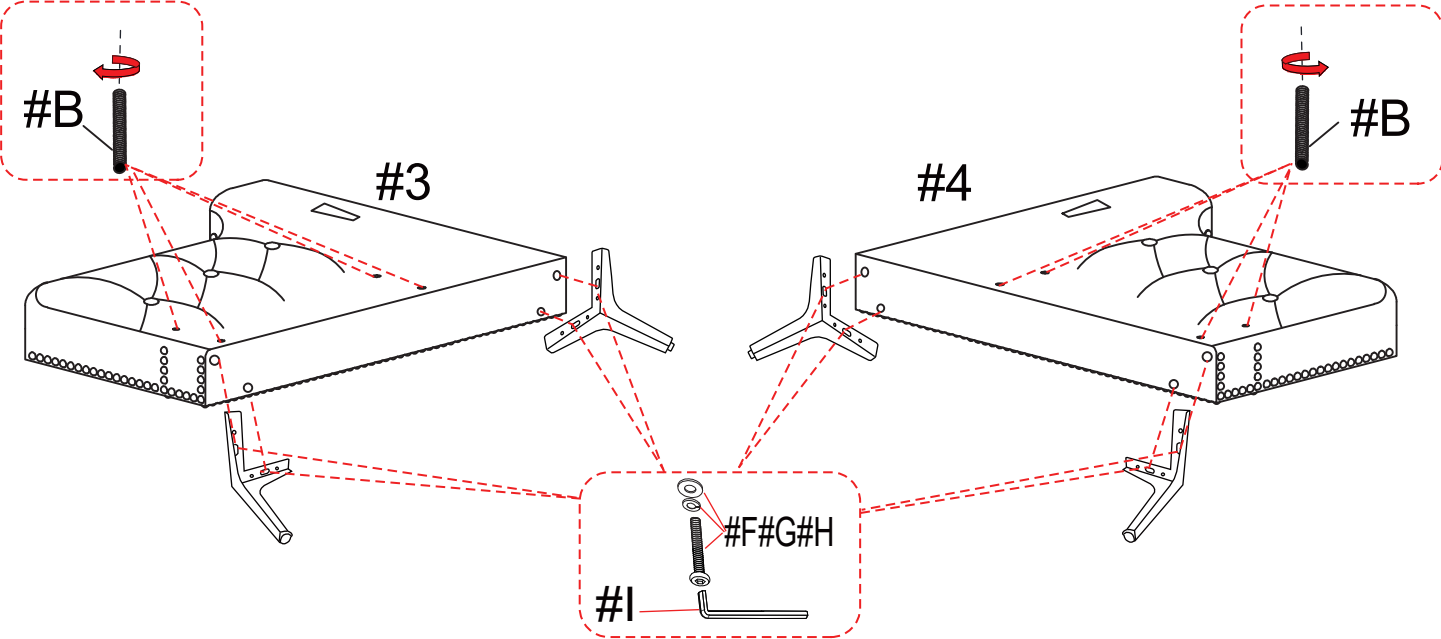

STEP 2:

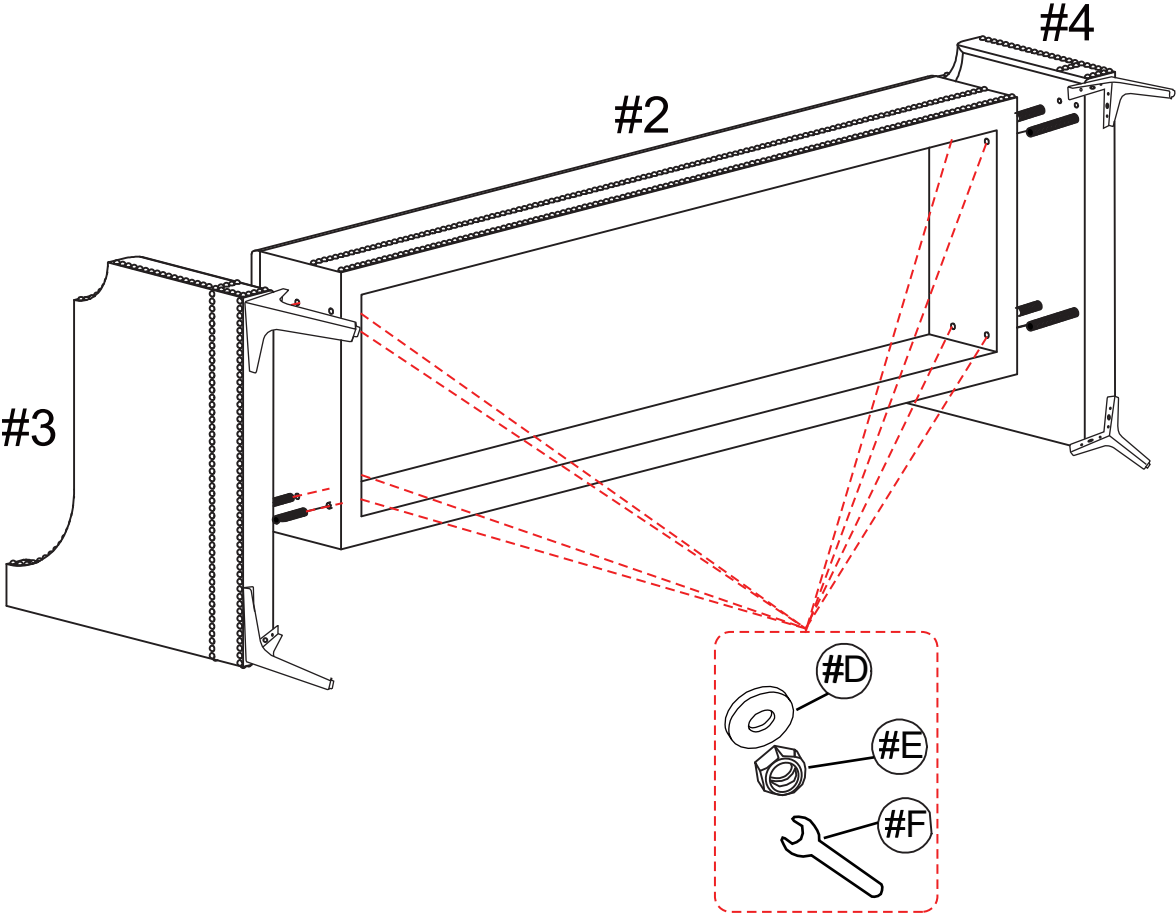

ASSEMBLY INSTRUCTIONS

STEP3:

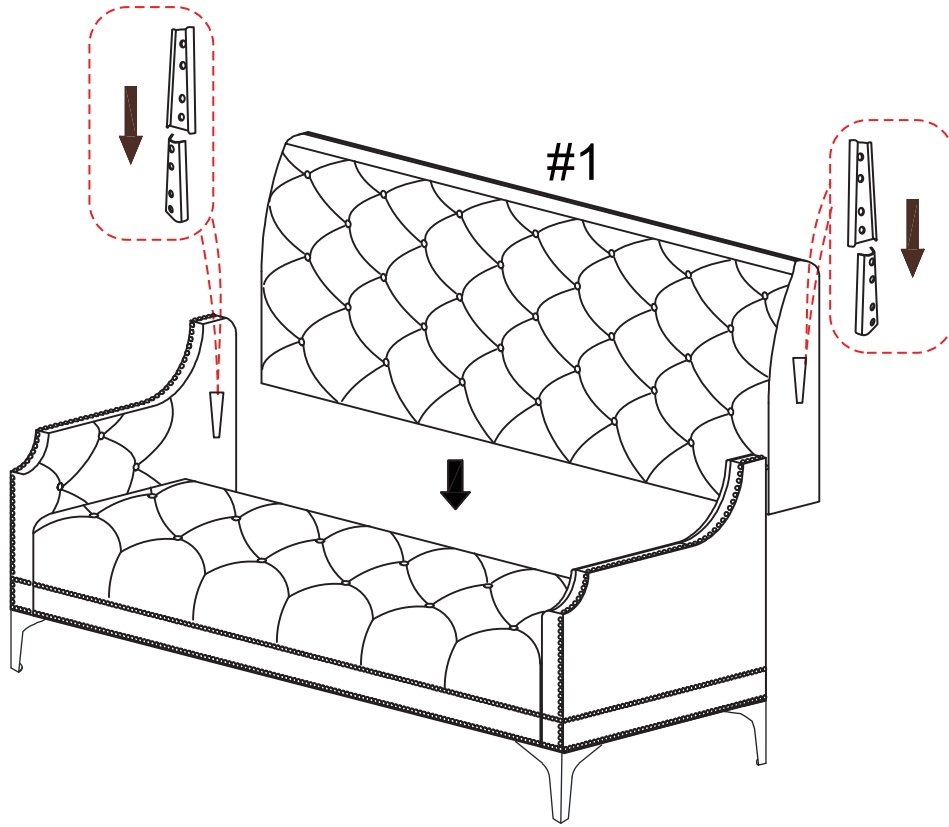

STEP4:

