

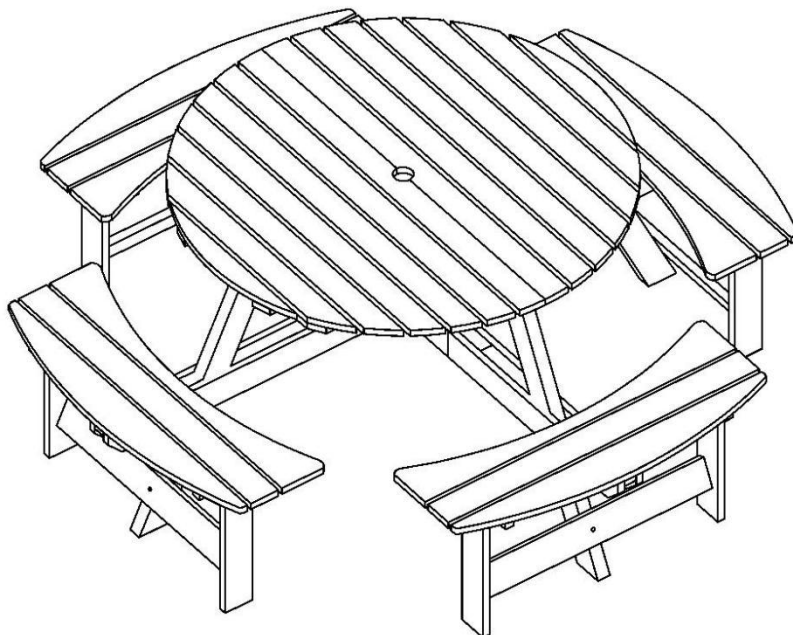

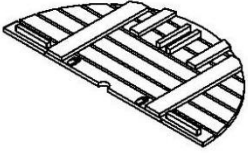

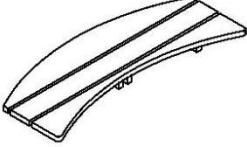

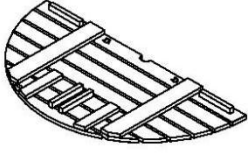

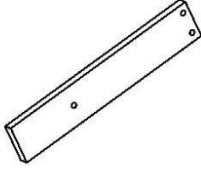
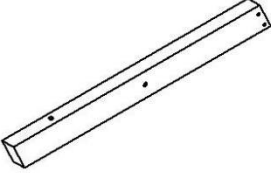
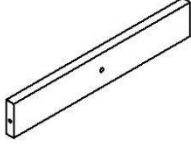

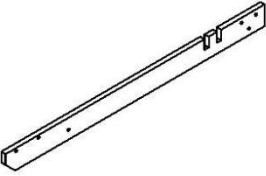



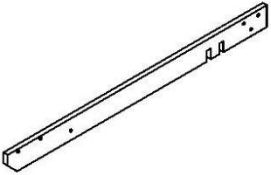

# Outdoor Picnic Table Instruction Manual (8-Person)

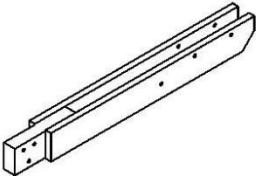



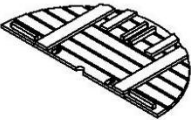
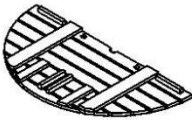

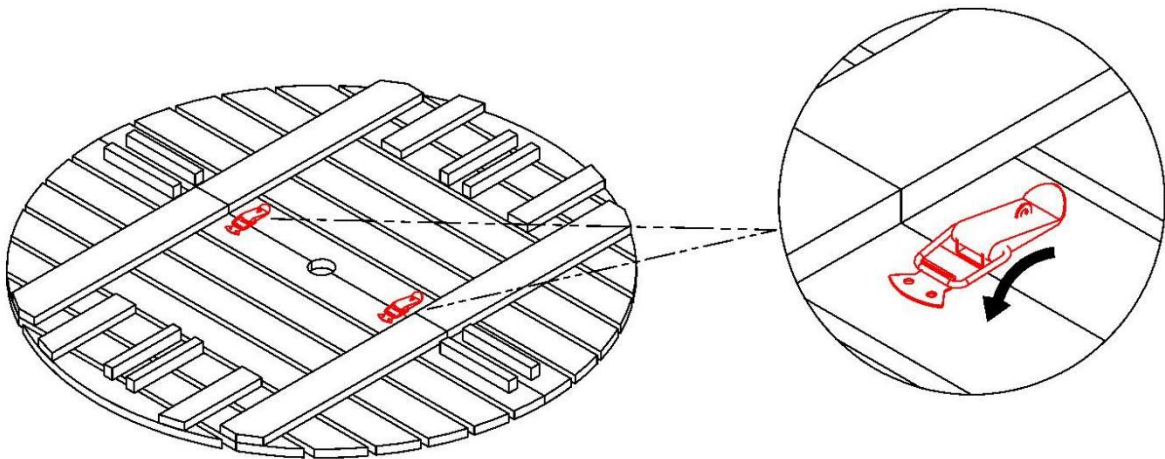
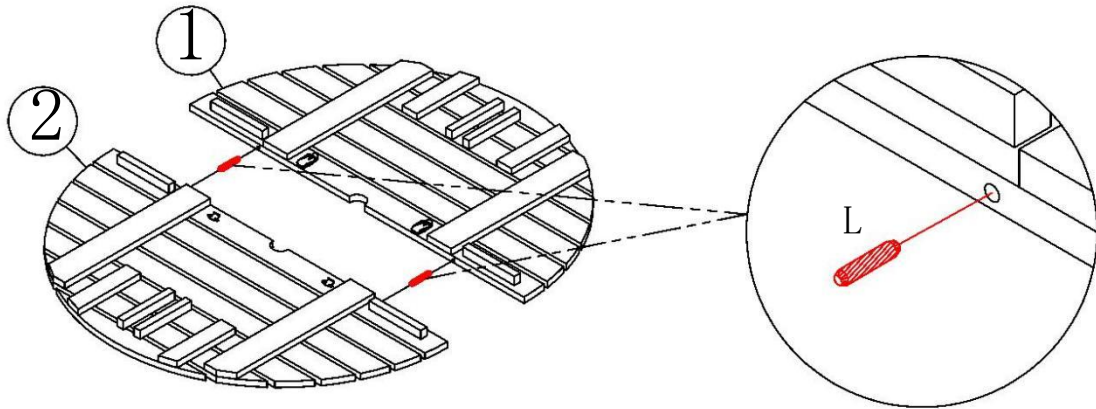

①		1PC	⑦		4PC
②		1PC	⑧		8PC
③		4PC	⑨		4PC
			A		26PC
			B		28PC
④		2PC	C		10PC
			D		26PC
			E		26PC
			F		52PC
⑤		2PC	G		28PC
			H		28PC
			I		1PC
⑥		2PC	J		1PC
			K		1PC
			L		2PC

1

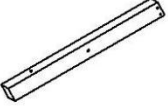
①	②	L
		
1PC	1PC	2PC



2

③	A	E	F	D	J	I
						
4PC	8PC	8PC	16PC	8PC	1PC	1PC

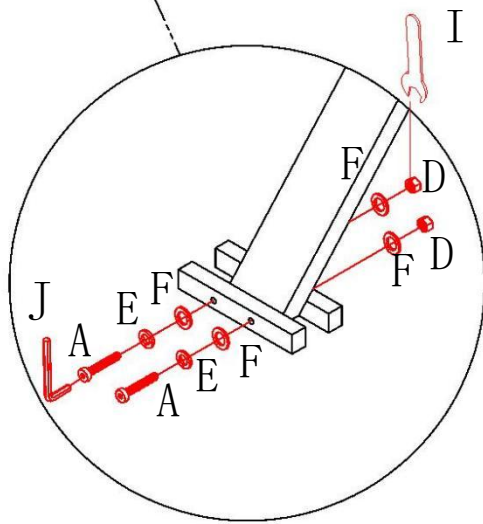
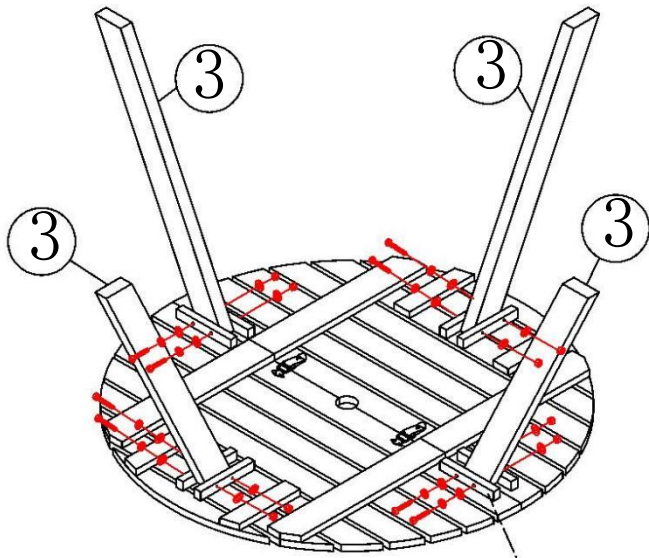





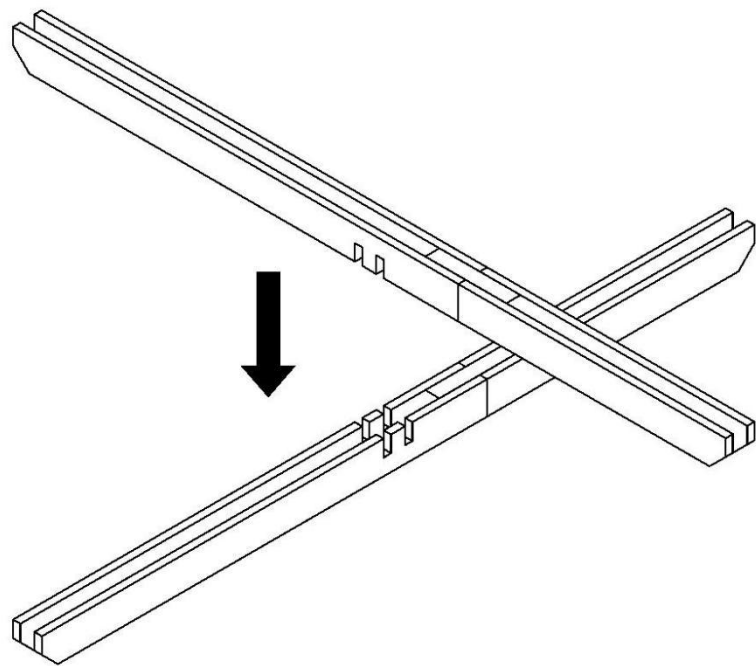
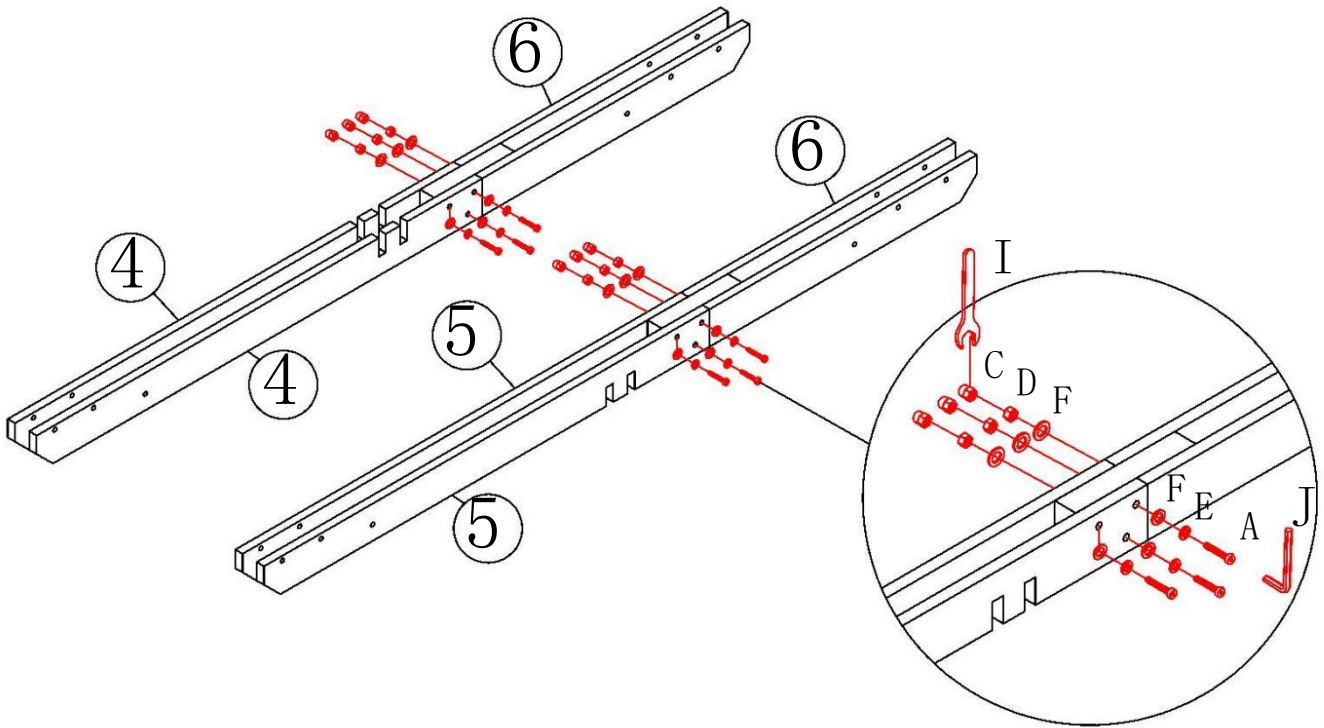

3

④	⑤	⑥	A	E	F	D	C	J	I
2PC	2PC	2PC	6PC	6PC	12PC	6PC	6PC	1PC	1PC





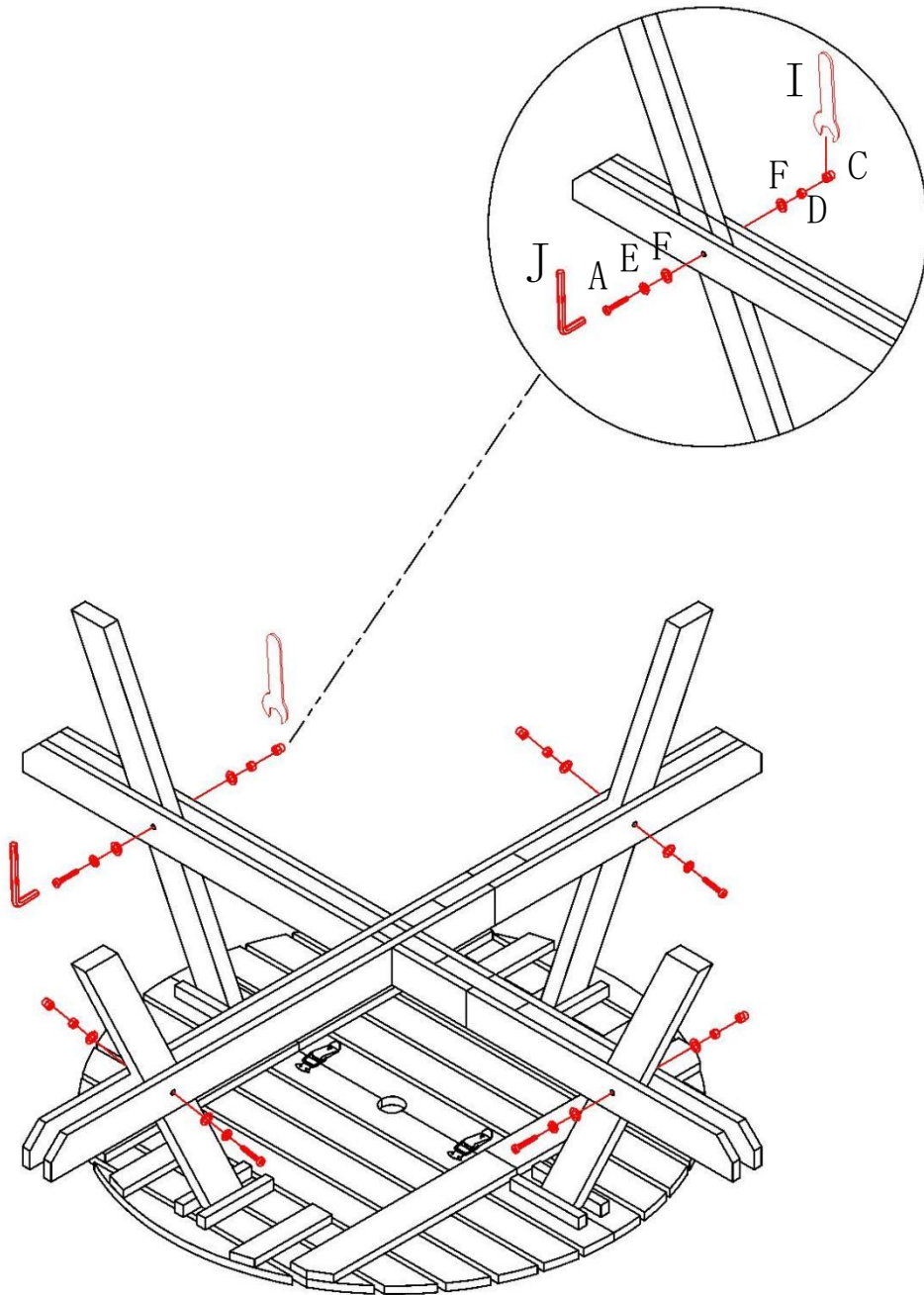

4

A	E	F	D	C	J	I
						
4PC	4PC	8PC	4PC	4PC	1PC	1PC

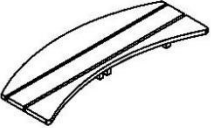
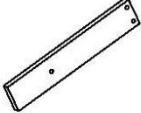
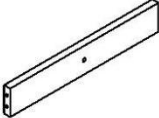





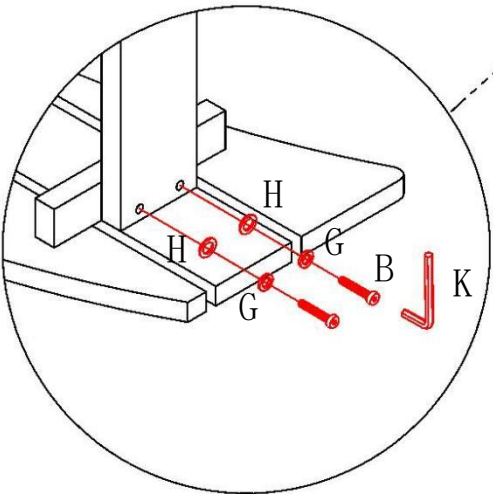
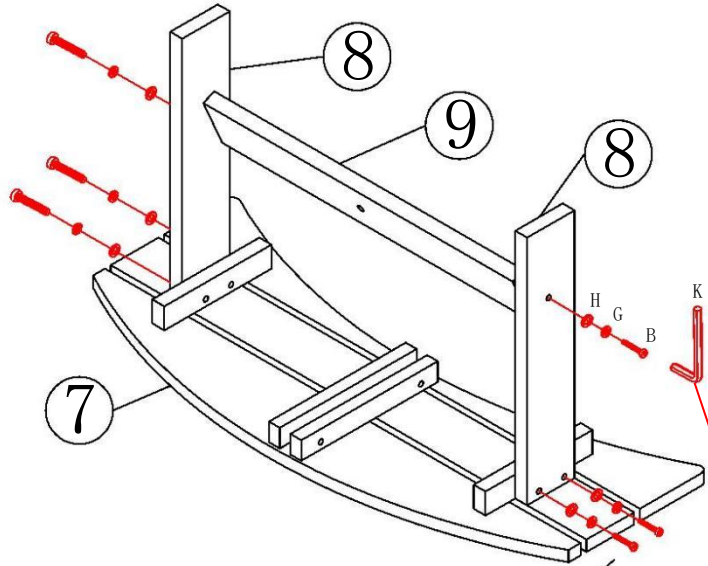

# 5

⑦	⑧	⑨	B	G	H	K
						
4PC	8PC	4PC	24PC	24PC	24PC	1PC





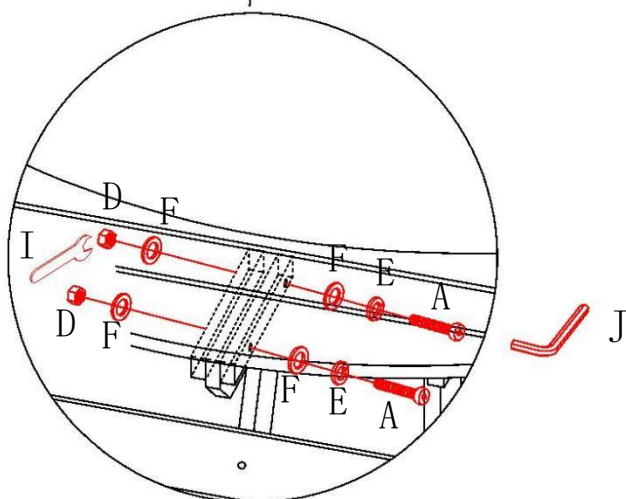
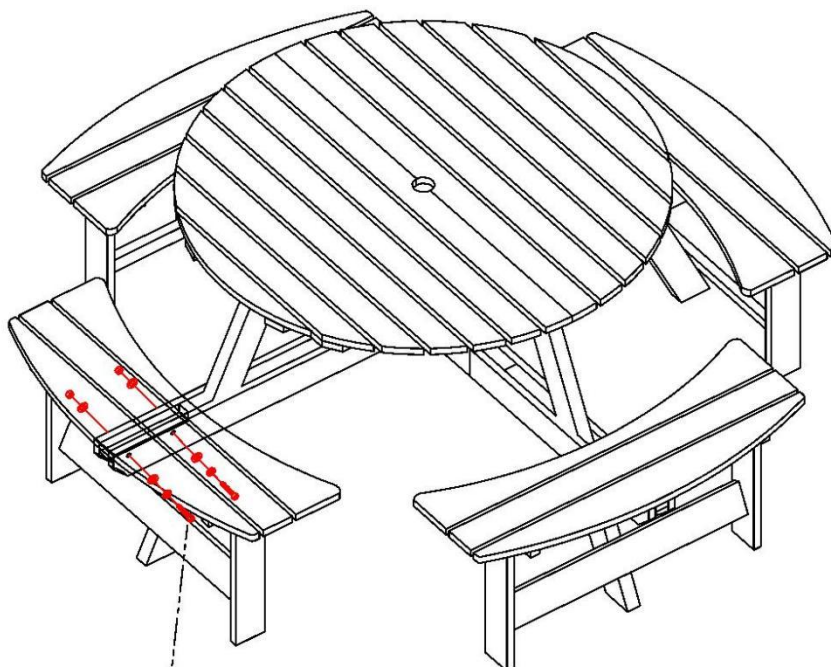

Note: Do not tighten the side plate (8) and side plate (9) screws completely. Wait until step 7 is completed before tightening. Prevent the board (9) holes from not fitting properly.

# 6

A	E	F	D	J	I
					
8PC	8PC	16PC	8PC	1PC	1PC



7

B	G	H	K
			
4PC	4PC	4PC	1PC

