

# HISENSE HAP0824TWD USE AND INSTALLATION MANUAL

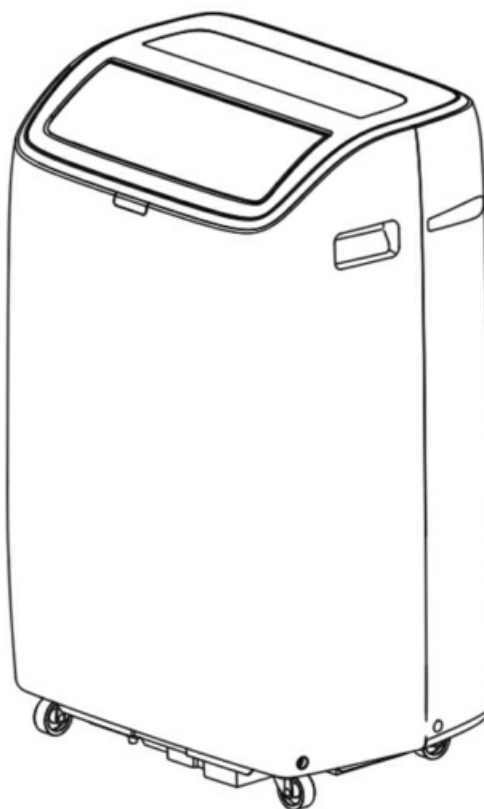

## Quick Links

[Pre-Installation](#)

[Operation](#)

[Using the Control Panel](#)

[Care and Cleaning](#)

[Draining the Air Conditioner](#)

[Troubleshooting](#)

# Table of Contents

Table of Contents

Safety Information

IMPORTANT SAFETY INSTRUCTIONS

DISPOSING OF THE UNIT

Pre-Installation

Planning Installation

Tools Required

Hardware Included

Package Contents

Electrical Requirements

Location Requirements

Unpack The Air Conditioner

Window Vent Panel and Extensions

Installation

Operation

Using the Control Panel

POWER ON OR OFF

FAN SPEED

Using The Remote Control

INSERT THE BATTERIES

HOW TO USE

BUTTON FUNCTIONS

Normal Sounds

Care and Cleaning

Draining the Air Conditioner

Cleaning the Outside

Cleaning the Air Filter

Storing After Use

Troubleshooting

Other ManualsLib Projects

ITM. / ART. 2691084

# Hisense

## USE AND INSTALLATION MANUAL

Model: HAP0824TWD

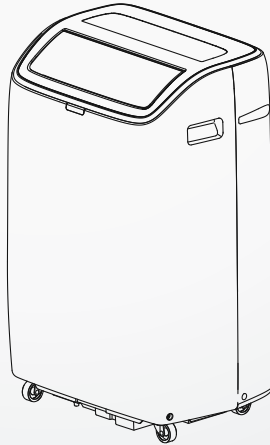

For questions about features, operation/ performance, parts or service,  
call: 1-877-465-3566

Operating hours (EST): Monday-Friday from 9 a.m. to 9 p.m.

Saturday-Sunday from 9 a.m. to 6 p.m.

Language: English and Spanish

# Table of Contents

Safety Information .....	2	Location Requirements .....	9
Pre-Installation .....	6	Unpack The Air Conditioner .....	10
Planning Installation .....	6	Window Vent Panel and Extensions .....	10
Tools Required .....	6	Installation .....	11
Hardware Included .....	6	Operation .....	14
Package Contents .....	7	Care and Cleaning .....	20
Electrical Requirements .....	8	Troubleshooting .....	22

## Safety Information

Your safety and the safety of others are very important. We have provided many important safety messages in this manual and on your appliance. Please always read and obey all safety messages. To reduce the risk of fire, electrical shock or injury when using your air conditioner, please follow these basic precautions:



### IMPORTANT SAFETY INSTRUCTIONS

- Plug into a grounded 3-prong outlet.
- Do not remove ground prong.
- Do not use an electrical adapter.
- Do not use an extension cord.
- Unplug air conditioner before servicing.
- Use two or more people to move and install air conditioner.
- If the SUPPLY CORD is damaged, it must be replaced by the manufacturer, its service agent or similarly qualified persons in order to avoid a hazard.





### DISPOSING OF THE UNIT

- Before throwing out the device, it is necessary to remove the battery cells and dispose or recycle them properly.
- When you need disposal of the unit consult our dealer. If pipes are removed incorrectly, refrigerant may blow out and come into contact with your skin, causing injury. Releasing refrigerant into the atmosphere also damages the environment.
- Please recycle or dispose of the product packaging material in an environmentally responsible manner.
- Do not store or ship the air conditioner upside down or sideways to avoid damage to the compressor. If the air conditioner was upside down or sideways, please keep upright at least 2 hours before use to prevent damaging the compressor.
- This appliance is not intended for use by persons (including children) with reduced physical, sensory or mental capabilities, or lack of experience and knowledge, unless they have been given supervision or instruction concerning use of the appliance by a person responsible for their safety. Children should be supervised to ensure that they do not play with the appliance.
- The wiring diagram is shown on nameplate on the air conditioner.

All safety messages will tell you what the potential hazard is and tell you how to reduce the chance of injury.

	<b>DANGER:</b> A hazard that if not avoided will result in serious injury or death.
	<b>WARNING:</b> A hazard that if not avoided could result in serious injury or death.
	<b>CAUTION:</b> A hazard that if not avoided may result in minor or moderate injury.

Explanation of symbols displayed on the unit.

	<b>WARNING</b>	This symbol shows that this appliance uses a flammable refrigerant. If the refrigerant is leaked and exposed to an external ignition source, there is a risk of fire.
	<b>CAUTION</b>	This symbol shows that the operation manual should be read carefully.
	<b>CAUTION</b>	This symbol shows that a service personnel should be handling this equipment with reference to the installation manual.
	<b>CAUTION</b>	This symbol shows that information is available such as the operating manual or installation manual.

Circuit diagram

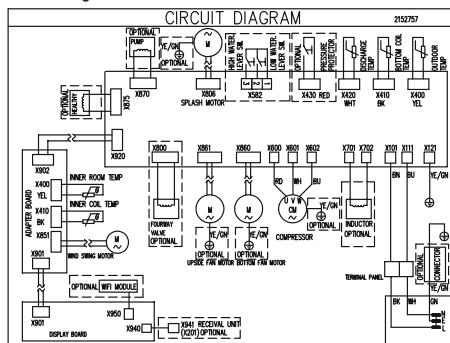

## Safety Information (continued)

### Precautions for using R32 refrigerant

The basic installation work procedures are the same as the conventional refrigerant (R22 or R410A). However, pay attention to the following:

#### 1. Transport of equipment containing flammable refrigerants

- Compliance with the transport regulations.

#### 2. Marking of equipment using signs

- Compliance with local regulations.

#### 3. Disposal of equipment using flammable refrigerants

- Compliance with national regulations.

#### 4. Storage of equipment/appliances

- The storage of equipment should be in accordance with the manufacturer's instructions.

#### 5. Storage of packed (unsold) equipment

- Storage package protection should be constructed such that mechanical damage to the equipment inside the package will not cause a leak of the refrigerant charge.
- The maximum number of pieces of equipment permitted to be stored together will be determined by local regulations.

#### 6. Information on servicing

- **Checks to the area:** Prior to beginning work on systems containing flammable refrigerants, safety checks are necessary to ensure that the risk of ignition is minimised. For repair to the refrigerating system, the following precautions shall be complied with prior to conducting work on the system.

- **Work procedure:** Work shall be undertaken under a controlled procedure so as to minimise the risk of flammable gas or vapour being present while the work is being performed.

- **General work area:** All maintenance staff and others working in the local area shall be instructed on the nature of work being carried out. Work in confined spaces shall be avoided. The area around the workspace shall be sectioned off. Ensure that the conditions within the area have been made safe by control of flammable material.

- **Checking for presence of refrigerant:** The area shall be checked with an appropriate refrigerant detector prior to and during work, to ensure the technician is aware of potentially flammable atmospheres. Ensure that the leak detection equipment being used is suitable for use with flammable refrigerants, i.e. non-sparking, adequately sealed or intrinsically safe.

- **Presence of fire extinguisher:** If any hot work is to be conducted on the refrigeration equipment or any associated parts, appropriate fire extinguishing equipment shall be available to hand. Have a dry powder or CO<sub>2</sub> fire extinguisher adjacent to the charging area.

- **No ignition sources:** No person carrying out work in relation to a refrigeration system which involves exposing any pipe work that contains or has contained flammable refrigerant shall use any sources of ignition in such a manner that it may lead to the risk of fire or explosion. All possible ignition sources, including cigarette smoking, should be kept sufficiently far away from the site of installation, repairing, removing and disposal, during which flammable refrigerant can possibly be released to the surrounding space. Prior to work taking place, the area around the equipment is to be surveyed to make sure that there are no flammable hazards or ignition risks. "No Smoking" signs shall be displayed.

- **Ventilated area:** Ensure that the area is in the open or that it is adequately ventilated before breaking into the system or conducting any hot work. A degree of ventilation shall continue during the period that the work is carried out. The ventilation should safely disperse any released refrigerant and preferably expel it externally into the atmosphere.

- **Checks to the refrigeration equipment:** Where electrical components are being changed, they shall be fit for the purpose and to the correct specification. At all times the manufacturer's maintenance and service guidelines shall be followed. If in doubt consult the manufacturer's technical department for assistance. The following checks shall be applied to installations using flammable refrigerants: The charge size is in accordance with the room size within which the refrigerant containing parts are installed; The ventilation machinery and outlets are operating adequately and are not obstructed; If an indirect refrigerating circuit is being used, the secondary circuit shall be checked for the presence of refrigerant; Marking to the equipment continues to be visible and legible. Markings and signs that are illegible shall be corrected; Refrigeration pipe or components are installed in a position where they are unlikely to be exposed to any substance which may corrode refrigerant containing components, unless the components are constructed of materials which are inherently resistant to being corroded or are suitably protected against being so corroded.

- **Checks to electrical devices:** Repair and maintenance to electrical components shall include initial safety checks and component inspection procedures. If a fault exists that could compromise safety, then no electrical supply shall be connected to the circuit until it is satisfactorily dealt with. If the fault can not be corrected immediately but it is necessary to continue operation, an adequate temporary solution shall be used.

- This shall be reported to the owner of the equipment so all parties are advised. Initial safety checks shall include: That capacitors are discharged: this shall be done in a safe manner to avoid possibility of sparking; That there no live electrical components and wiring are exposed while charging, recovering or purging the system; That there is continuity of earth bonding.

#### 7. Repairs to sealed components

- During repairs to sealed components, all electrical supplies shall be disconnected from the equipment being worked upon prior to any removal of sealed covers, etc.

- If it is absolutely necessary to have an electrical supply to equipment during servicing, then a permanently operating form of leak detection shall be located at the most critical point to warn of a potentially hazardous situation.

- Particular attention shall be paid to the following to ensure that by working on electrical components, the casing is not altered in such a way that the level of protection is affected.

- This shall include damage to cables, excessive number of connections, terminals not made to original specification, damage to seals, incorrect fitting of glands, etc.

- Ensure that apparatus is mounted securely.

- Ensure that seals or sealing materials have not degraded such that they no longer serve the purpose of preventing the ingress of flammable atmospheres.

# Safety Information (continued)

- Replacement parts shall be in accordance with the manufacturer's specifications.



**NOTE:** The use of silicon sealant may inhibit the effectiveness of some types of leak detection equipment. Intrinsically safe components do not have to be isolated prior to working on them.

## 8. Repairs to intrinsically safe components

- Do not apply any permanent inductive or capacitance loads to the circuit without ensuring that this will not exceed the permissible voltage and current permitted for the equipment in use.
- Intrinsically safe components are the only types that can be worked on while live in the presence of a flammable atmosphere. The test apparatus shall be at the correct rating.
- Replace components only with parts specified by the manufacturer. Other parts may result in the ignition of refrigerant in the atmosphere from a leak.

## 9. Cabling

- Check that cabling will not be subject to wear, corrosion, excessive pressure, vibration, sharp edges or any other adverse environmental effects.
- The check shall also take into account the effects of aging or continual vibration from sources such as compressors or fans.

## 10. Detection of flammable refrigerants

- Under no circumstances shall potential sources of ignition be used in these arching for or detection of refrigerant leaks.
- A halide torch (or any other detector using a naked flame) shall not be used.

## 11. Leak detection methods

- The following leak detection methods are deemed acceptable for systems containing flammable refrigerants:
  - Electronic leak detectors shall be used to detect flammable refrigerants, but the sensitivity may not be adequate, or may need re-calibration. (Detection equipment shall be calibrated in a refrigerant-free area.)
  - Ensure that the detector is not a potential source of ignition and is suitable for the refrigerant used.
  - Leak detection equipment shall be set at a percentage of the LFL of the refrigerant and shall be calibrated to the refrigerant employed and the appropriate percentage of gas (25 % maximum) is confirmed.
  - Leak detection fluids are suitable for use with most refrigerants but the use of detergents containing chlorine shall be avoided as the chlorine may react with the refrigerant and corrode the copper pipe-work.
  - If a leak is suspected, all naked flames shall be removed/ extinguished.
  - If a leakage of refrigerant is found which requires brazing, all of the refrigerant shall be recovered from the system, or isolated (by means of shutoff valves) in a part of the system remote from the leak.
  - Oxygen free nitrogen (OFN) shall then be purged through the system both before and during the brazing process.

## 12. Removal and evacuation

- When breaking into the refrigerant circuit to make repairs - or for any other purpose - conventional procedures shall be used. However, for flammable refrigerants it is important that best

practice be followed, since flammability is a consideration. The following procedure shall be adhered to:

- safely remove refrigerant following local and national regulations;
  - purge the circuit with inert gas;
  - evacuate (optional for A2L);
  - purge with inert gas (optional for A2L);
  - open the circuit by cutting or brazing;
- The refrigerant charge shall be recovered into the correct recovery cylinders if venting is not allowed by local and national codes. For appliances containing flammable refrigerants, the system shall be purged with oxygen - free nitrogen to render the appliance safe for flammable refrigerants. This process might need to be repeated several times. Compressed air or oxygen shall not be used for purging refrigerant systems.
  - For appliances containing flammable refrigerants, refrigerants purging shall be achieved by breaking the vacuum in the system with oxygen - free nitrogen and continuing to fill until the working pressure is achieved, then venting to atmosphere, and finally pulling down to a vacuum (optional for A2L). This process shall be repeated until no refrigerant is within the system (optional for A2L). When the final oxygen - free nitrogen charge is used, the system shall be vented down to atmospheric pressure to enable work to take place.
  - Ensure that the outlet for the vacuum pump is not close to any potential ignition sources and that ventilation is available.

## 13. Charging procedures

- In addition to conventional charging procedures, the following requirements shall be followed:
  - Ensure that contamination of different refrigerants does not occur when using charging equipment.
  - Hoses or lines shall be as short as possible to minimise the amount of refrigerant contained in them.
  - Cylinders shall be kept upright.
  - Ensure that the refrigeration system is earthed prior to charging the system with refrigerant.
  - Label the system when charging is complete (if not already).
  - Extreme care shall be taken not to overfill the refrigeration system.
- Prior to recharging the system it shall be pressure tested with OFN.
- The system shall be leak tested on completion of charging but prior to commissioning.
- A follow up leak test shall be carried out prior to leaving the site.

## 14. Decommissioning

- **For professional technicians only.**
- Before carrying out this procedure, it is essential that the technician is completely familiar with the equipment and all its detail.
- It is recommended good practice that all refrigerants are recovered safely.
- Prior to the task being carried out, an oil and refrigerant sample shall be taken in case analysis is required prior to re-use of reclaimed refrigerant. It is essential that electrical power is available before the task is commenced.
  - Become familiar with the equipment and its operation.
  - Isolate system electrically.
  - Before attempting the procedure ensure that:
    - Mechanical handling equipment is available, if required,

## Safety Information (continued)

for handling refrigerant cylinders;

- All personal protective equipment is available and being used correctly;
- The recovery process is supervised at all times by a competent person;
- Recovery equipment and cylinders conform to the appropriate standards.
- d) Pump down refrigerant system, if possible.
- e) If a vacuum is not possible, make a manifold so that refrigerant can be removed from various parts of the system.
- f) Make sure that cylinder is situated on the scales before recovery takes place.
- g) Start the recovery machine and operate in accordance with manufacturer's instructions.
- h) Do not overfill cylinders. (No more than 80 % volume liquid charge).
- i) Do not exceed the maximum working pressure of the cylinder, even temporarily.
- j) When the cylinders have been filled correctly and the process completed, make sure that the cylinders and the equipment are removed from site promptly and all isolation valves on the equipment are closed off.
- k) Recovered refrigerant shall not be charged into another refrigeration system unless it has been cleaned and checked.

### 15. Labelling

- Equipment shall be labelled stating that it has been de-commissioned and emptied of refrigerant (**for technicians only**).
- The label shall be dated and signed.  
Ensure that there are labels on the equipment stating the equipment contains flammable refrigerant.

### 16. Recovery

- When removing refrigerant from a system, either for servicing or decommissioning, it is recommended good practice that all refrigerants are removed safely (**for technicians only**).
- When transferring refrigerant into cylinders, ensure that only appropriate refrigerant recovery cylinders are employed.
- Ensure that the correct number of cylinders for holding the total system charge is available.
- All cylinders to be used are designated for the recovered refrigerant and labelled for that refrigerant (i.e. special cylinders for the recovery of refrigerant).
- Cylinders shall be complete with pressure relief valve and associated shut-off valves in good working order.
- Empty recovery cylinders are evacuated and, if possible, cooled before recovery occurs.
- The recovery equipment shall be in good working order with a set of instructions concerning the equipment that is at hand and shall be suitable for the recovery of flammable refrigerants.
- In addition, a set of calibrated weighing scales shall be available and in good working order.
- Hoses shall be complete with leak-free disconnect couplings and in good condition.
- Before using the recovery machine, check that it is in satisfactory working order, has been properly maintained and that any associated electrical components are sealed to prevent ignition in the event of a refrigerant release.

- Consult manufacturer if in doubt.
- Opening of the refrigeration systems shall not be done by brazing.
- The recovered refrigerant shall be returned to the refrigerant supplier in the correct recovery cylinder, and the relevant Waste Transfer Note arranged.
- Do not mix refrigerants in recovery units and especially not in cylinders.
- If compressors or compressor oils are to be removed, ensure that they have been evacuated to an acceptable level to make certain that flammable refrigerant does not remain within the lubricant.
- The evacuation process shall be carried out prior to returning the compressor to the suppliers.
- Only electric heating to the compressor body shall be employed to accelerate this process.
- When oil is drained from a system, it shall be carried out safely.



**WARNING:** Risk of Fire or Explosion. This unit contains flammable refrigerant.

Additional safety precautions must be followed.

- Do not use means to accelerate the defrosting process or to clean, other than those recommended by the manufacturer.
- The appliance shall be stored in a room without continuously operating ignition sources (for example: open flames, an operating gas appliance or an operating electric heater).
- Do not pierce or burn refrigerant tubing. Be aware that refrigerants may not contain an odor.
- Compliance with national gas regulations shall be observed.
- Keep ventilation openings clear of obstruction.
- The maximum refrigerant charge amount is shown on nameplate on the air conditioner.
- When handling, installing, and operating the appliance, care should be taken to avoid damage to the refrigerant tubing.
- Do not drill holes in the unit.
- Maintenance, cleaning, and service should only be performed by technicians properly trained and qualified in the use of flammable refrigerants.
- Dispose of air conditioner in accordance with Federal and Local Regulations. Flammable refrigerants require special disposal procedures. Contact your local authorities for the environmentally safe disposal of your air conditioner.
- The appliance shall be stored so as to prevent mechanical damage from occurring.
- The appliance shall be stored in a well-ventilated area where the room size corresponds to the room area as specified for operation.
- This product contains small parts such as (batteries, battery cover and screws) that may cause suffocation if swallowed by children.



# Pre-Installation

## PLANNING INSTALLATION

Gather the required tools and parts before starting installation. Check that all parts are included in parts package. Read and follow the instructions provided with any tools listed here.

## TOOLS REQUIRED



Phillips  
screwdriver



Scissors



Pencil

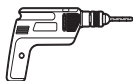

Cordless  
drill



1/8 in. Drill bit

## HARDWARE INCLUDED



AA

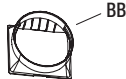

BB



CC



DD



EE

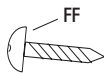

FF

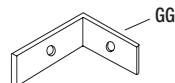

GG

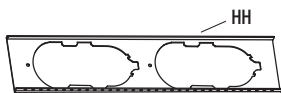

HH



II



JJ



KK

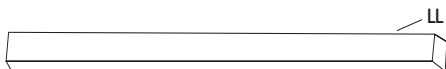

LL

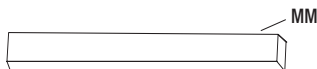

MM



NN



OO

Part	Description	Quantity
AA	Foam seal (non-adhesive)	1
BB	Coupling	2
CC	Flexible exhaust hose	2
DD	Window exhaust adapter	2
EE	Rivets	4
FF	Screws	4
GG	Window lock bracket	2
HH	Outer slider section with vent	1
II	Inner slider section-short	1

Part	Description	Quantity
JJ	Inner slider section	1
KK	Outer slider section	1
LL	Foam seal-long (adhesive)	3
MM	Foam seal-short (adhesive)	2
NN	Remote Control	1
OO	Standard AAA (1.5 volt) batteries	2

## Pre-Installation (continued)

### BATTERY NOTES:



- Battery type: mercury free super heavy duty R03 UM-4 size AAA 1.5V.
- Best used before date code (month-year) on the battery.
- Caution for ingestion: the battery may cause suffocation if swallowed by children.
- Do not mix old and new batteries. Do not mix alkaline, standard (carbon - zinc), or rechargeable (nickel - cadmium) batteries.
- Non-rechargeable batteries are not to be recharged.
- Exhausted batteries are to be removed from the product.
- DO NOT DISPOSE OF BATTERIES IN FIRE. BATTERIES MAY EXPLODE OR LEAK.

### PACKAGE CONTENTS

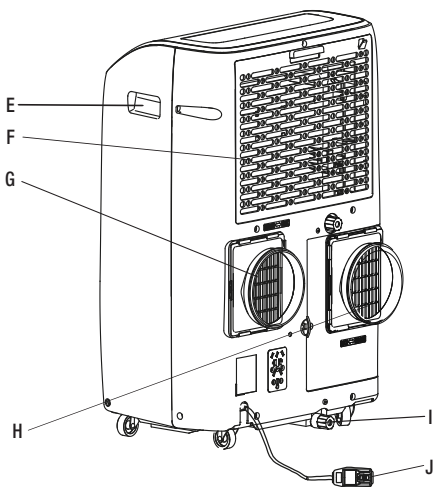
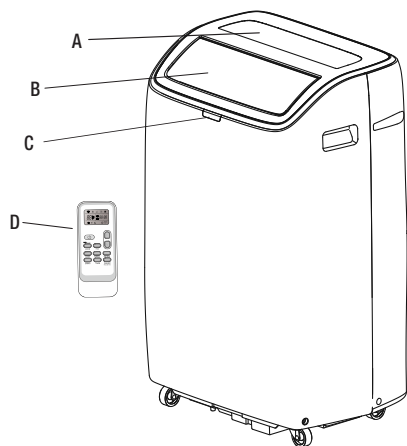

Part	Description
A	Control panel
B	Cool air outlet
C	Signal receptor
D	Remote control
E	Transport handle
F	Evaporator air intake
G	Air outlet hose coupling
H	Condenser air intake
I	Primary drain port
J	Power cord (may differ from the one shown)

# Pre-Installation (continued)

## ELECTRICAL REQUIREMENTS

### WARNING:



- Plug into a grounded 3-prong outlet.
- Do not remove ground prong.
- Do not use an adapter.
- Do not use an extension cord. The appliance shall be installed in accordance with national wiring regulations.
- Failure to follow these instructions can result in electrical shock, fire, or death.

### Recommended Grounding Method

This portable air conditioner must be grounded. This portable air conditioner is equipped with a power supply cord with a three-prong grounding plug. The cord must be plugged into a properly grounded three-prong outlet, grounded in accordance with all local codes and ordinances. If a properly grounded outlet is not available, it is the customer's responsibility to have a properly grounded three-prong outlet installed by a qualified electrician.

### Customer's Responsibility

- To contact a qualified electrician.
- To assure that the electrical installation is adequate and conforms to the national electrical code, ANSI/NFPA 70-last edition, and all local codes and ordinances.

Copies of the standards listed may be obtained from:

National Fire Protection Association

1 Batterymarch Park

Quincy, MA 02169-7471

[www.nfpa.org](http://www.nfpa.org)

### Wiring Requirement

Power supply	Time-delay fuse (or circuit breaker)
115V 103.5V min. 126.5V max.	15A

### Power Supply Cord



**NOTE:** Your air conditioner's device may differ from the one shown. This room air conditioner is equipped with a power supply cord required by UL. This power supply cord contains state-of-the-art electronics that sense leakage current. If the cord is crushed, the electronics detect leakage current and power will be disconnected in a fraction of a second.

To test your power supply cord:

1. Plug power supply cord into a grounded 3-prong outlet.
2. Press RESET (2) (on some devices, a green light will turn on).
3. Press TEST (1) and listen for click. The RESET button will trip, and on some devices, a green light will turn off.
4. Press and release RESET (2) and listen for click. The RESET button will latch, and on some devices, a green light will turn on. The power supply cord is ready for operation.

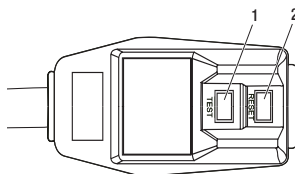

### NOTE:



- The RESET button must be pushed in for proper operation.
- The power supply cord must be replaced if it fails to trip when the test button is pressed or fails to reset.
- Do not use the power supply cord as an off/on switch. The power supply cord is designed as a protective device.
- If the SUPPLY CORD is damaged, it must be replaced by the manufacturer, its service agent or similarly qualified persons in order to avoid a hazard.
- The power supply cord contains no user serviceable parts. Opening the tamper-resistant case voids all warranty and performance claims.

# Pre-Installation (continued)

## LOCATION REQUIREMENTS

The flexible exhaust hose allows placement of the air conditioner at least 20 in. from window or door.

Confirm you are using the correct size air conditioner for the space to be cooled, per sizing recommendations, below:

Area to be cooled		DOE Capacity needed (BTUs)
Up to 10 ft x 15 ft room	150 sq. ft	5,000
Up to 10 ft x 25 ft room	250 sq.ft	6,000
Up to 15 ft x 20 ft room	300 sq. ft	7,000
Up to 10 ft x 35 ft room	350 sq. ft	8,000
Up to 15 ft x 30 ft room	450 sq. ft.	10,000
Up to 10 ft x 55 ft room	550 sq. ft.	12,000



**NOTE:** Match BTUs to room use and location: Shaded room, reduce to next smaller size; sunny room, increase to next larger size; for kitchens, increase to next larger size.



**WARNING:** The length of the exhaust hose is specially designed according to the specification of the product. Do not replace, extend, or otherwise modify the hose.

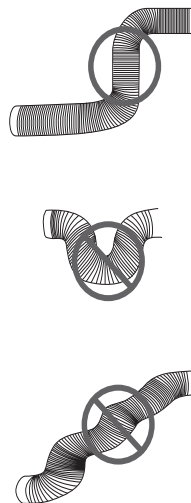
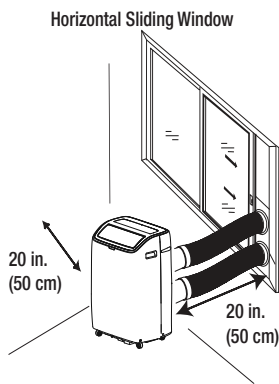
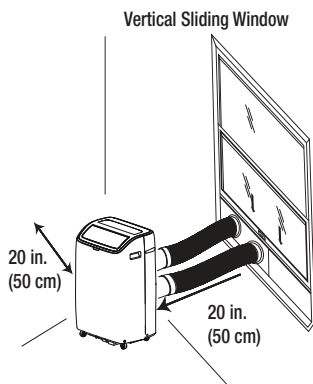

**NOTE:** For best performance, allow at least 20 in. of air space on all sides of the unit for good air circulation.



- Do not block the air outlet.
- Provide easy access to the grounded 3-prong outlet.
- To ensure proper function, DO NOT overextend or bend the hose. Make sure that there is no obstacle around the air outlet of the exhaust hose in order for the exhaust system to work properly. All the illustrations in this manual are for explanation purposes only. Your air conditioner may be slightly different. The actual shape shall prevail.

# Pre-Installation (continued)



**WARNING:** Use two or more people to move and install air conditioner. Failure to do so can result in back or other injury.

## Remove Packaging Materials

- Remove and recycle packaging materials.
- Remove tape and glue residue from surfaces before turning on the air conditioner. Rub a small amount of liquid dish soap over the adhesive with your fingers. Wipe with warm water and dry.
- Do not use sharp instruments, rubbing alcohol, flammable fluids, or abrasive cleaners to remove tape or glue. These products can damage the surface of your air conditioner.
- Handle the air conditioner gently.



**IMPORTANT:** Keep unit upright at least 2 hours prior to use.



**CAUTION:** Installation accessories are stored in the top of the carton and are required for proper cooling performance. Please remove all accessories from packing materials before use.

## WINDOW VENT PANEL AND EXTENSIONS

The window installation kit allows you to install the air conditioner in most vertical-sliding windows 18 in. to 50 in. wide, or horizontal sliding windows from 18 in. to 50 in. tall. Check your window size and choose the fit from the table. If your window size requires more than two panels, after adjusting the length, please secure the panels with rivets (EE).

Panel Length / Window Length	Panel HH (18 in.)	Panel II (19-11/16 in.)	Panel JJ (18 in.)	Panel KK (18 in.)	See Figure...
18 in.	X				A
19 in. – 26 in.	X	X			B
27 in. – 34 in.	X		X		C
35 in. – 50 in.	X		X	X	D

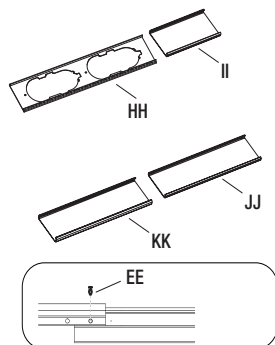

**Figure A**

For an 18 in. window opening, use the window vent panel (HH) by itself.

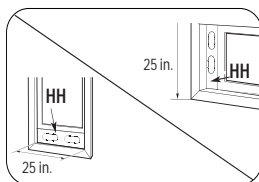

**Figure B**

For window openings from 19 in. to 26 in., use the window vent panel (HH) and a extension panel (II).

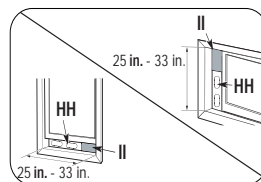

**Figure C**

For window openings from 27 in. to 34 in., use the window vent panel (HH) and a extension panel (JJ).

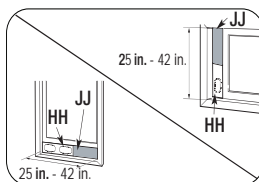

**Figure D**

For window openings from 35 in. to 50 in., use the window vent panel (HH) and two extension panels (KK and JJ).

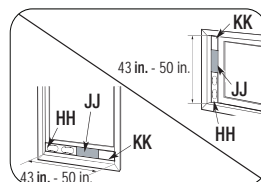

## 1 Attaching Exhaust Hose and Adapter to Air Conditioner

- Roll the air conditioner to selected location. See “Location Requirements” on page 9.
- Press the coupling (BB) into the flexible exhaust hose (CC). The hose has integral clips that snap onto the coupling.
- Insert the coupling (BB) into the slot on the back of the air conditioner.
- Slide down to lock the hose into place.
- Confirm the hose is locked in place before operating.

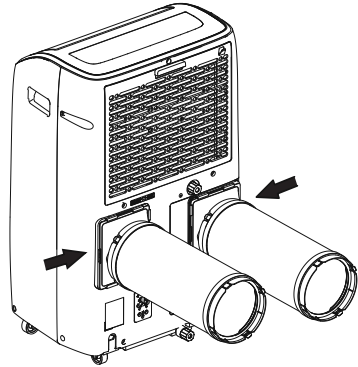
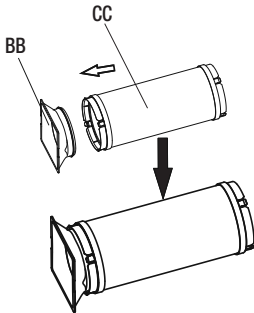

## 2 Attaching Exhaust Hose to Window Vent

- Your window installation kit has been designed to fit most standard vertical and horizontal window applications. Roll the air conditioner to selected location. See “Location Requirements” on page 9.
- Place the window exhaust adapter (DD) on the outer slider section (HH) (the piece with the large exhaust hole).
- Slide the window exhaust adapter (DD) to lock in place (please follow direction on the adapter).



**NOTE:** Product must be used with included Duct Window Installation kit for effective cooling.

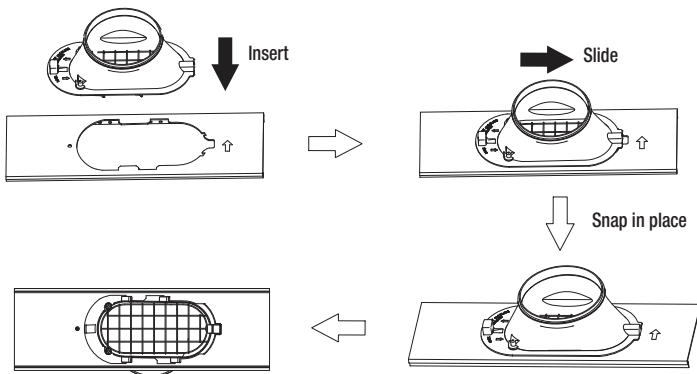

## Installation (continued)

### 2a Installing in Vertical Sliding Window



**NOTE:** The window installation kit can be used with vertical sliding windows between 18 in. and 50 in. wide.

- Cut the foam seal (LL) (adhesive type-long) to the proper length, and attach it to the window sash and frame.

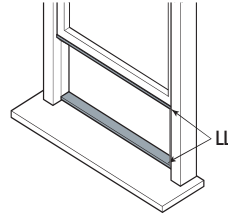

- Insert the vent panel assembly (HH), including extension panels, if needed, into the window opening. Extend the extension panels to the window width.



**NOTE:** The arrow on the slider section points towards the window.

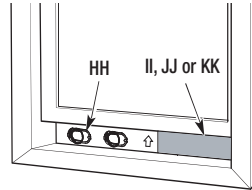

- Cut the foam seal (AA) (non-adhesive type) to the window width. Stuff the foam seal (AA) between the glass and the window to prevent air and foreign objects from getting into the room.

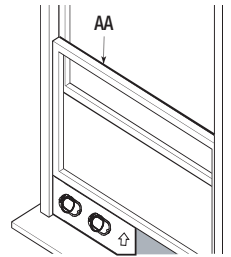

- Install the window lock bracket (GG) with screw (FF) as shown, if needed.

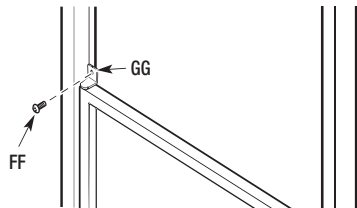

- Attach the exhaust hose to snap onto the window exhaust adaptor.

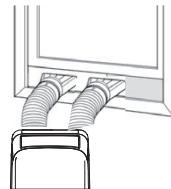

### 2b Installing in Horizontal Sliding Window

- Cut the foam seal (LL) (adhesive type-long) to the proper length, and attach it to the window sash and frame.

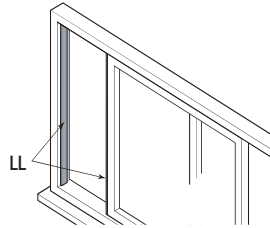

- Insert the vent panel assembly, including extension panels, if needed, into the window opening. Extend the extension panels, if used.



**NOTE:** The arrow on the slider section points towards the window.

- Cut the foam seal (AA) (non-adhesive type) to the window width. Stuff the foam seal (AA) between the glass and the window to prevent air and foreign objects from getting into the room.

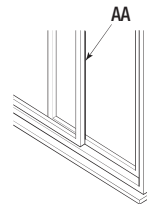
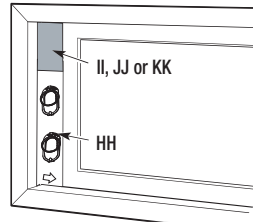

- Install the window-lock bracket (GG) with screw (FF) as shown.

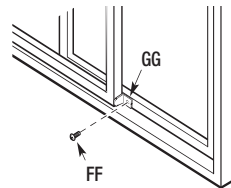

- Attach the exhaust hose to snap onto the window exhaust adaptor.

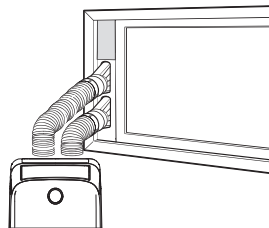

# Operation

Operating your portable air conditioner properly helps you to obtain the best possible results. This section explains air conditioner operation.

**IMPORTANT:**  Keep upright at least 2 hours before use to prevent damaging the compressor.



For better performance, operate COOL or DRY mode within the following recommended range: Outdoor temperature 62.6-109.9°F (17-43.3°C) with relative humidity ≤90%; indoor temperature 62.6-89.6°F (17-32°C) with relative humidity ≤80%.

In the event of a power failure, your air conditioner will operate at the previous settings when the power is restored.

Do not stay in direct airflow from the air conditioner for extended periods of time.

Never use in tightly enclosed spaces. Always ensure there is sufficient airflow of outside air entering the household especially when used in conjunction with combustible devices such as gas stoves, fireplaces, furnaces, hot water heaters etc. Do not place the power cord or air conditioner near a heater, radiator, stoves or other apparatus (including amplifiers) that produce heat.



**NOTE:**

This air conditioner is designed for residential household use only. Avoid using it for commercial precision climate control or with precision equipment, for preserving food, for pets, plants, artwork, and similar purposes.

Do not block or obstruct the exhaust vent hose as it may severely affect performance, or cause failure of the air conditioner.

The air conditioner display shows the current room temperature.

When changing modes while the air conditioner is in operation, the compressor will stop for 3 to 5 minutes before restarting. If a button is pressed during this time, the compressor will not restart for another 3 to 5 minutes.

In Cooling or Dry mode, the compressor and condenser fan will stop when the room temperature reaches the set temperature.

In Dry mode, the humidity level is automatically set, but is not able to be displayed.

## 1 Using the Control Panel

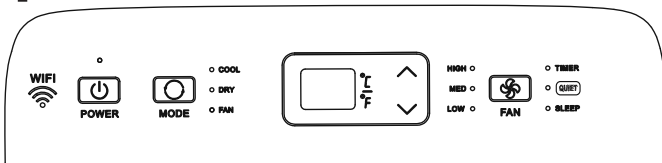

**NOTE:** The symbols may be different from these models, but the functions are similar.

### POWER ON OR OFF



POWER

The first time the air conditioner is plugged in and turned on after your purchase, it will be set in Cool Mode.

When the air conditioner is turned on at all other times, it will run according to the previous setting.



MODE

### MODE

Press and release MODE until you see the symbol for the desired setting. Operating modes are Cool, Dry, Fan, or Heat.

COOL

**Cool** - Cools the room. Press FAN to select High, Medium or Low speeds. Press the Plus or Minus button to adjust the temperature.

DRY

**Dry** - Dries the room. The air conditioner automatically selects the temperature. The fan runs on Low speed only. Dehumidification ranges between 2 to 3 pints per hour by model.



**NOTE:** Dry mode should not be used to cool the room.

FAN

**Fan Only** - Press FAN to select High, Medium or Low fan speed.

## Operation (continued)

WIFI



- Wi-Fi control is available for connected models with this logo on the control panel. Please see "Using the ConnectLife APP" for Wi-Fi connection introduce on page 19.



FAN

### FAN SPEED

- Press and release FAN to choose the desired fan speed.

HIGH ○

- **High** - for maximum fan speed

MED ○

- **Med**-for normal fan speed

LOW ○

- **Low** - for minimum fan speed

### TEMPERATURE



- Press the **UP** button to raise the temperature. Press the **UP** button once to increase the set temperature by 1 °F (1 °C).

- Press the **DOWN** button to lower the temperature. Press the **DOWN** button once to decrease the set temperature by 1 °F (1 °C).



- To change the temperature display between °F and °C. Press both the UP and DOWN buttons at the same time.



**NOTE:** In Cooling mode, the temperature can be set between 61 °F and 86 °F (16 °C and 30 °C).  
In Fan Only mode, the temperature cannot be set.  
The unit's LED shows the target temperature for 5 seconds and then displays the room temperature.

○ QUIET

### QUIET

- Press the QUIET button to enter the quiet mode.
- Quiet mode is available for inverter model with this logo on the control panel.

## 2 Using the Remote Control

### INSERT THE BATTERIES

- Remove the battery cover along the arrowed direction.
- Insert new batteries making sure that the (+) and (-) of battery are matched correctly.
- Reattach the cover by sliding it back into position.

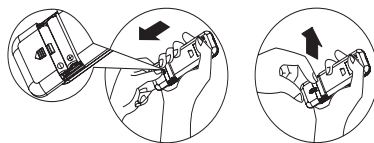

#### NOTE:

- Use 2 standard AAA (1.5 volt) batteries. Do not use rechargeable batteries.
- Replace batteries with new ones of the same type when the display becomes dim, or after 6 months.
- When replacing batteries, always replace both batteries with new batteries. Do not mix old and new batteries. Do not mix alkaline, standard (carbon-zinc), or rechargeable (Ni-Cd, Ni-MH, etc.) batteries.
- If the air conditioner will not be used for an extended period of time, remove the batteries from the remote.
- DO NOT DISPOSE OF BATTERIES IN FIRE. BATTERIES MAY EXPLODE OR LEAK.



**CAUTION:** Do not use the remote before cleaning if the batteries have leaked. The chemicals in batteries could cause burns or other health hazards. Please contact customer service if there is any question.

# Operation (continued)

## 2 Using the Remote Control (continued)

### STORAGE TIP

- The holder on the back of the unit can be used to store the remote control.

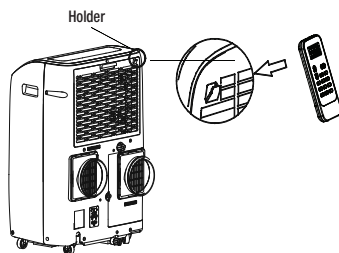

### HOW TO USE

- To operate the room air conditioner, aim the remote control at the signal receptor (1).
- The remote control will operate the air conditioner at a distance of up to 23 ft. (7 m) when pointing at signal receptor of the air conditioner.

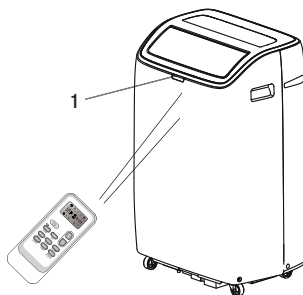

### BUTTON FUNCTIONS

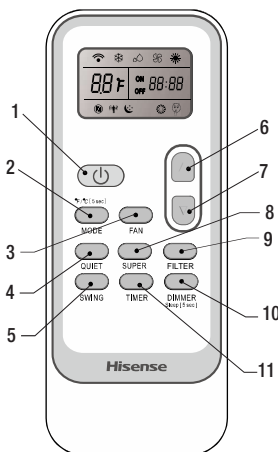

- 1 On/Off
- 2 Mode
- 3 Fan
- 4 Quiet
- 5 Swing
- 6 Up
- 7 Down
- 8 Super
- 9 Filter
- 10 Dimmer/ Sleep
- 11 Timer

### INDICATION SYMBOLS

- ❄️ Cool indicator
- 💧 Dry indicator
- 🌀 Fan only indicator
- ☀️ Heating indicator
- ⚙️ Auto fan speed
- ⚙️ High fan speed
- ❄️ Medium fan speed
- 🌀 Low fan speed
- 🌙 Sleep indicator
- 📶 Signal transmission
- 88°F Display set temperature
- 👤 Quiet indicator

**NOTE:** Remote control may differ in appearance.  
**FILTER** function is not available on this model.



Press and hold the **MODE** button on the remote for 5 seconds to swift temperature display from Fahrenheit (°F) to Celsius (°C).

## Operation (continued)

### 2 Using the Remote Control (continued)

Sleep [ 5 sec ]



DIMMER

#### DIMMER

- Press the DIMMER button to turn off the control panel display.



**NOTE:** When in Dimmer mode, new control inputs will return display to normal.

Sleep [ 5 sec ]



DIMMER

#### SLEEP

- Sleep mode can only be set in Cooling, Heating or Drying modes. When in Sleep mode the unit will utilize lower, quieter fanspeeds and automatic temperature adjustments offering 8 hours of optimal sleeping conditions before shutting off.



**NOTE:** The appliance will stop operation automatically after operating for 8 hours. Fan speed is automatically set at low speed. In the Cooling mode, if the current room temperature is below 79 °F (26 °C), the temperature will automatically increase 1°F (1 °C) during the first hour after Sleep mode is activated, and continue running at that temperature. If the room temperature is 79 °F (26 °C) or above, set temperature will not change.

In Heating mode, the set temperature will decrease by 6 °F (3 °C) at most, during 3 hours, and continues running at that temperature until auto shut off.

Sleep mode cannot be selected in Fan mode.

°F/°C [ 5 sec ]



MODE

- Press MODE to select COOL, DRY, or FAN.
- Press the UP or DOWN button to set the temperature.
- Press and hold the DIMMER button on the remote for 5 seconds to switch the Dimmer mode to the Sleep mode.
- After 5 seconds, the lights on the control panel display will dim.



**NOTE:** The temperature and airflow direction may be adjusted during Sleep mode. The fan speed is automatically set to Low speed. After 5 seconds, the lights on the control panel display will dim again.

Press and hold the MODE button on the remote for 5 seconds to switch the temperature display from Fahrenheit (°F) to Celsius (°C).

- To turn off Sleep mode, press MODE, FAN, SLEEP, SUPER or wait 8 hours for Sleep mode to turn off automatically.



**NOTE:** The air conditioner will return to previous settings after Sleep mode is turned off.



SUPER

#### SUPER

The SUPER button is used to start or stop fast cooling.

- After pressing the Super button, the air conditioner will automatically set the fan speed to High and the temperature to 61°F (16°C).
- To exit Super mode, press either MODE, FAN, QUIET, SLEEP or SUPER on the remote control.



**NOTE:** In the Super mode, you can set the timer.

## 2 Using the Remote Control (continued)



TIMER

### TIMER

- Use the TIMER function to turn the air conditioner ON/OFF automatically.

#### Setting the Air Conditioner to Turn On:

- Plug in the air conditioner and use the remote to power it ON.
- Use the remote to set the desired mode, temperature, fan speed, etc.
- Use the remote to power OFF the air conditioner.
- Press TIMER on the remote and use the UP/ DOWN buttons to set the desired delay time until the air conditioner turns ON. The delay time can be set from 0 to 24 hours in one-hour increments.
- Press TIMER again to confirm the delay time. The Timer light on the unit will be on.

#### Setting the Air Conditioner to Turn Off:

- Plug in the air conditioner and use the remote to power it ON.
- Use the remote to set the desired mode, temperature, fan speed, etc.
- Press TIMER on the remote and use the UP/ DOWN buttons to set the desired delay time until the air conditioner turns OFF. The delay time can be set from 0 to 24 hours in one-hour increments.
- Press TIMER again to confirm the delay time. The Timer light on the unit will be on.

#### To Cancel Timer:

Press the TIMER button again. Once a “beep” is heard and the indicator disappears, the Timer mode has been canceled.



**NOTE:** The Timer mode can only be set by the remote control.



SWING

### SWING

- Press SWING once to change the vertical airflow direction.
- Press again to hold the louver in a desired position.

#### NOTE:



- Airflow is automatically adjusted to a preset direction after turning on the unit.
- The direction of airflow can be adjusted by pressing the SWING button.
- To prevent damage, do not turn the airflow louvers manually.
- Turning the louver manually will disrupt normal operation. To recover, simply restart the air conditioner.

## 3 Normal Sounds

When your air conditioner is operating normally, you may hear sounds such as:

1. Air movement from the fan.
2. Clicks from the thermostat cycling.
3. Vibration or noise due to poor wall or window construction.
4. A high-pitched hum or pulsating noise caused by the high-efficiency compressor cycling on and off.

### 4 Using the ConnectLife APP

The ConnectLife APP by Hisense provides the below features for your convenience:

- ❑ Remote control & status: Turn ON/OFF, change the mode, set & monitor the temperature, and quick action buttons.
- ❑ Scheduler: define when your AC can automatically turn ON/OFF to defined temperatures and modes.
- ❑ Remote diagnostics: easily check the health of your device.
- ❑ Linkage with Amazon Alexa and Google Home: to easily control your AC with voice command.

#### DEVICES REQUIRED TO USE THE SMART AC:

- ❑ Smart air conditioner.
- ❑ Wireless Router (a 2.4 GHz network is required to connect).
- ❑ Smart Phone with compatible iOS or Android system.

#### DOWNLOAD AND INSTALL THE CONNECTLIFE APP



- ❑ Scan to download the ConnectLife APP.
- ❑ You can also go to Google Play or App Store and search for the ConnectLife APP.
- ❑ Follow the in-APP instructions to pair your appliance.

## Care and Cleaning

### 1 Draining the Air Conditioner

Below are situations in which you should drain the air conditioner:

- **When Relocating:** When you need to move the air conditioner, it's important to drain it to prevent water from overflowing onto the floor or carpet due to tilting during transportation..
- **Before Storage:** It is advisable to empty the water from the air conditioner before storing it to prevent the development of odors, mold, and bacteria..
- **In High Humidity Conditions:** In extremely humid conditions, the air conditioner is more likely to accumulate excess condensation water. It will automatically shut down and display an E5 error code once the water pan is full. It's necessary to unplug the air conditioner and drain it before resuming normal operation.



**WARNING: Excessive Weight Hazard**

Use two or more people to move and install the air conditioner. Failure to do so can result in back or other injury.

- Unplug the air conditioner or disconnect power.
- Move the air conditioner to a drain location or outside.



**NOTE:** To avoid leaking water from the unit, move the air conditioner slowly and keep it level.

- Remove the primary drain cover (1) and plug (2).
- Drain water completely through the drain hole.



**NOTE:** If the air conditioner will be stored after use, see "Storing After Use".

- Reinstall the drain plug to the primary drain hole.
- Reinstall the primary drain cover to the drain hole.
- Reposition the air conditioner.
- Plug in the air conditioner or reconnect power.

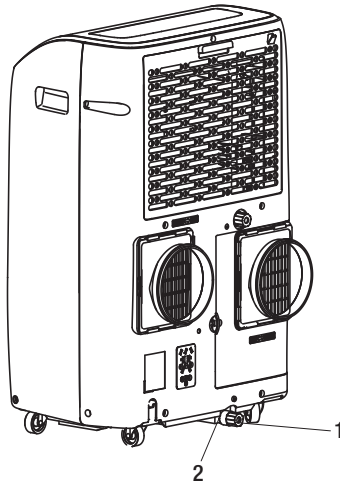

### 2 Cleaning the Outside

- Turn off the air conditioner.
- Unplug air conditioner or disconnect power.
- Remove the air filter and clean separately. See "Cleaning Air Filter".
- Wipe the outside of the air conditioner with a soft, damp cloth.



**NOTE:** Please do not use strong detergents that contain wax or thinners, as it will cause discoloration or even damage to the panel.

- Plug in the air conditioner or reconnect power.
- Start the air conditioner.

## Care and Cleaning (continued)

### 3 Cleaning the Air Filter

- Unplug the air conditioner or disconnect power.
- Open the filter panel door (1) on the back of the air conditioner and remove.
- Use a vacuum cleaner to clean the filter. If the filter is very dirty, wash the filter in warm water with a mild detergent.



**NOTE:** Do not wash the filter in the dishwasher or use any chemical cleaner. Please call customer service for new filter purchase.

- Air dry the filter completely before replacing to ensure maximum efficiency.
- Reinstall the filter panel door.
- Start the air conditioner.

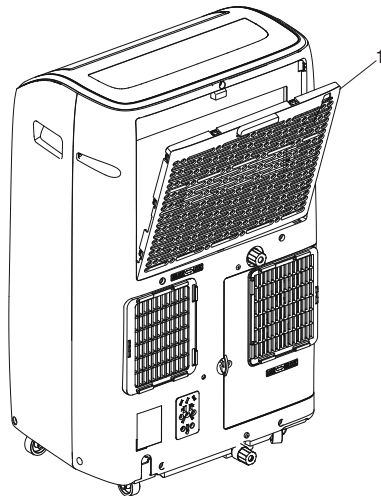

### 4 Storing After Use

If the air conditioner will not be used for an extended period of time:

- Unplug the air conditioner or disconnect power.
- Drain the water completely. See "Draining the Air Conditioner".
- Run the air conditioner set to Fan Only for approximately 12 hours to dry the air conditioner.
- Unplug the air conditioner.
- Remove the flexible exhaust hose and store with the air conditioner in a clean, dry area. See "Installation Instructions".
- Remove the window kit and store with the air conditioner in a clean, dry area. See "Installation Instructions".
- Remove the filter and clean. See "Cleaning the Air Filter".
- Clean the outside of the air conditioner. See "Cleaning the Outside".
- Reinstall the filter.
- Remove the batteries and store the remote control with the air conditioner in a clean, dry area.





**CAUTION:** Please recycle or dispose of the packaging material for product in an environmentally responsible manner. Never store or ship the air conditioner upside down or sideways to avoid damage to the compressor. Dispose of this appliance in accordance with Federal and Local regulations. Refrigerants must be evacuated before disposal.

Before using the air conditioner again:

- Make sure the filter and drain cap are in place.
- Check the power cord to make sure it is in good condition, with no cracks or damage.
- Place new batteries in the remote.
- Install the air conditioner. See "Installation Instruction".

# Troubleshooting

Before calling for service, please try the suggestion below.

Problem	Solution
Air conditioner will not operate	<div style="border: 1px solid black; padding: 5px; margin-bottom: 10px;"> <p style="text-align: center;"><b>DANGER: ELECTRICAL SHOCK HAZARD</b></p> <div style="display: flex; align-items: center;">  <ul style="list-style-type: none"> <li><input type="checkbox"/> Plug into a grounded 3-prong outlet.</li> <li><input type="checkbox"/> Do not remove ground prong.</li> <li><input type="checkbox"/> Do not use an adapter.</li> <li><input type="checkbox"/> Do not use an extension cord.</li> <li><input type="checkbox"/> Failure to follow these instructions can result in electrical shock, fire, or death.</li> </ul> </div> </div> <ul style="list-style-type: none"> <li><input type="checkbox"/> The power supply cord is unplugged. Plug into a grounded 3-prong outlet. See “Electrical Requirements” on page 8.</li> <li><input type="checkbox"/> Time-delay fuse or circuit breaker of the wrong capacity is being used. Replace with a time-delay fuse or circuit breaker of the correct capacity. See “Electrical Requirements” on page 8.</li> <li><input type="checkbox"/> The power supply cord has tripped (Reset button has popped out). Press and release RESET to resume operation. (Listen for click; RESET button will latch and remain in.)</li> <li><input type="checkbox"/> A household fuse has blown, or a circuit breaker has tripped. Replace the fuse, or reset the circuit breaker. See “Electrical Requirements” on page 8.</li> <li><input type="checkbox"/> The ON/OFF button has not been pressed. Press ON/OFF.</li> <li><input type="checkbox"/> The local power has failed. Wait for power to be restored.</li> </ul>
Air conditioner blows fuses or trips circuit breakers	<ul style="list-style-type: none"> <li><input type="checkbox"/> You are trying to restart the air conditioner too soon after turning off air conditioner. Wait at least 3 minutes after turning off air conditioner before trying to restart the air conditioner.</li> <li><input type="checkbox"/> Too many appliances are being used on the same circuit. Unplug or relocate appliances that share the same circuit.</li> </ul>
Air conditioner power supply cord trips (Reset button pops out)	<ul style="list-style-type: none"> <li><input type="checkbox"/> Disturbances in your electrical current can trip (RESET button will pop out) the power supply cord. Press and release RESET to resume operation. (Listen for click; RESET button will latch and remain in.)</li> <li><input type="checkbox"/> Electrical overloading, overheating, cord pinching or aging can trip (RESET button will pop out) the power supply cord.</li> <li><input type="checkbox"/> After correcting the problem, press and release RESET to resume operation. (Listen for click; RESET button will latch and remain in.) If the power cord fails to rest, contact a service technician.</li> </ul> <div style="border: 1px solid black; padding: 5px; margin-top: 10px;"> <div style="display: flex; align-items: center;">  <p><b>NOTE:</b> A damaged power supply cord must be replaced with a new power supply cord obtained from the product manufacturer and must not be repaired.</p> </div> </div>

## Troubleshooting (continued)

Problem	Solution
Air Conditioner seems to run too much	<ul style="list-style-type: none"> <li>□ A door or window is open. Keep doors and windows closed.</li> <li>□ The current air conditioner replaced an older model. The use of more efficient components may cause the air conditioner to run longer than an older model, but the total energy consumption will be less. Newer air conditioners do not emit the “blast” of cold air you may be accustomed to from older units, but this is not an indication of lesser cooling capacity or efficiency. Refer to the efficiency rating (EER) and capacity rating (in Btu/h) marked on the air conditioner.</li> <li>□ The air conditioner is in a heavily occupied room, or heat producing appliances are in use in the room. Use exhaust vent fans while cooking or bathing and try not to use heat-producing appliances during the hottest part of the day. Portable air conditioners are designed as supplemental cooling to local areas within a room. A higher capacity air conditioner may be required, depending on the size of the room being cooled.</li> </ul>
Air conditioner runs for a short time only, but room is not cool	<ul style="list-style-type: none"> <li>□ The setting temperature on the unit is too close to the room's actual temperature. Lower the setting temperature on the unit. See "Operation" on page 14.</li> </ul>
Display error code	<ul style="list-style-type: none"> <li>□ If the unit displays error code E5, the water container is full. Please drain the water, see “Draining the Air Conditioner” on page 20. The unit can be operated again after draining.</li> <li>□ If the unit displays error code E1/E2/E3/E6/E7/EA, please contact customer service.</li> </ul>
Air conditioner runs, but does not cool	<ul style="list-style-type: none"> <li>□ The filter is dirty or obstructed by debris. Clean the filter.</li> <li>□ Air outlet is blocked. Clear air outlet.</li> <li>□ The setting temperature is too high. Lower setting temperature.</li> </ul>
Air conditioner cycles on and off too much	<ul style="list-style-type: none"> <li>□ The air conditioner is not properly sized for your room. Check the cooling capabilities of your portable air conditioner. Portable air conditioners are designed as supplemental cooling to local areas within a room.</li> <li>□ The filter is dirty or obstructed by debris. Clean the filter.</li> <li>□ There is excessive heat or moisture, open container cooking, showers, etc. in the room. Use a fan to exhaust heat or moisture from the room. Try not to use heat-producing appliances during the hottest part of the day.</li> <li>□ The louvers are blocked. Install the air conditioner in a location where the louvers are free from curtains, blinds, furniture, etc.</li> </ul>

# Other ManualsLib Projects



[www.manualslib.com](http://www.manualslib.com)



[www.manualslib.de](http://www.manualslib.de)



[www.manualslib.es](http://www.manualslib.es)



[www.manualslib.fr](http://www.manualslib.fr)



[www.manualslib.nl](http://www.manualslib.nl)



[www.manualslib.mx](http://www.manualslib.mx)



[www.manualslib.tech](http://www.manualslib.tech) 30+ Languages