

# ASSEMBLY INSTRUCTIONS

## KING

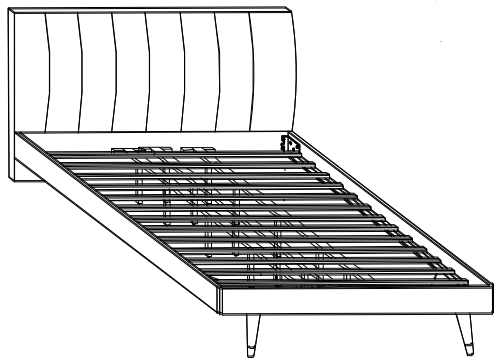

### + Parts Included

① Headboard & Footboard  
(1 of pc)

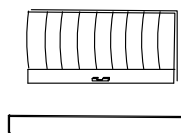

② Side Rail  
(2 of pcs)

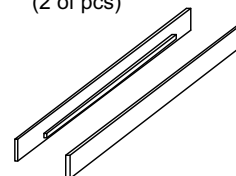

③ Bed Leg  
(2 of pcs)



④ Corner Block  
(2 of pcs)

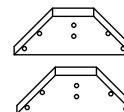

⑤ Support Leg  
(10 of pcs)

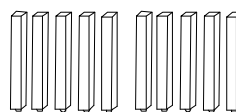

⑥ Center Rail  
(2 of pcs)

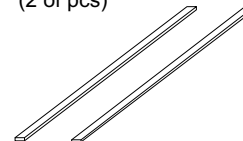

⑦ Slat  
(13 of pcs)



⑧ Wood Support  
(2 of pcs)

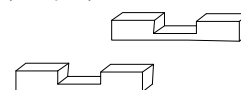

### + Do Not Use Power Tools



### + Suggested Adults

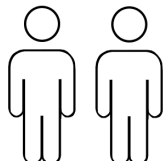

### NOTE:

- 1 Read instructions cover to cover.
- 2 Save all packaging until assembly is completed.

### 1 IMPORTANT SAFETY INFORMATION

**Do not** assemble the product if any of the following parts arrived damaged:

- Part # - Side Rails
- Part # - Center Support Bar
- Part # - Support Legs
- Part # - Slats

### 2 IMPORTANT ASSEMBLY INFORMATION

**Assembly Step** Ensure the side rail bracket is fully hooked onto bolt loosely threaded with both washers on the **OUTSIDE** of the bracket first, then proceed to fully tightening all 4 corners.

### + Hardware Included

**A** JCBC  
M6x50mm  
(12 of pcs)



**B** JCBC  
M6x60mm  
(10 of pcs)



**C** Flat Washer  
M6  
(12 of pcs)



**D** JCBB  
M8x50mm  
(4 of pcs)



**E** JCBB  
M8x16mm  
(8 of pcs)



**F** Flat Washer  
M8  
(4 of pcs)



**G** CSK  
M4x30mm  
(26 of pcs)

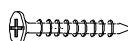

**H** Adjuster Screw  
(10 of pcs)



**I** JCBC  
M6 x 30mm  
(4 of pcs)



**J** Allen Key M4  
(1 of pc)



**K** Allen Key  
(1 of pc)



# ASSEMBLY INSTRUCTIONS

## KING

