

# ASSEMBLY INSTRUCTIONS

**Note:** No climbing on the back of the sofa!

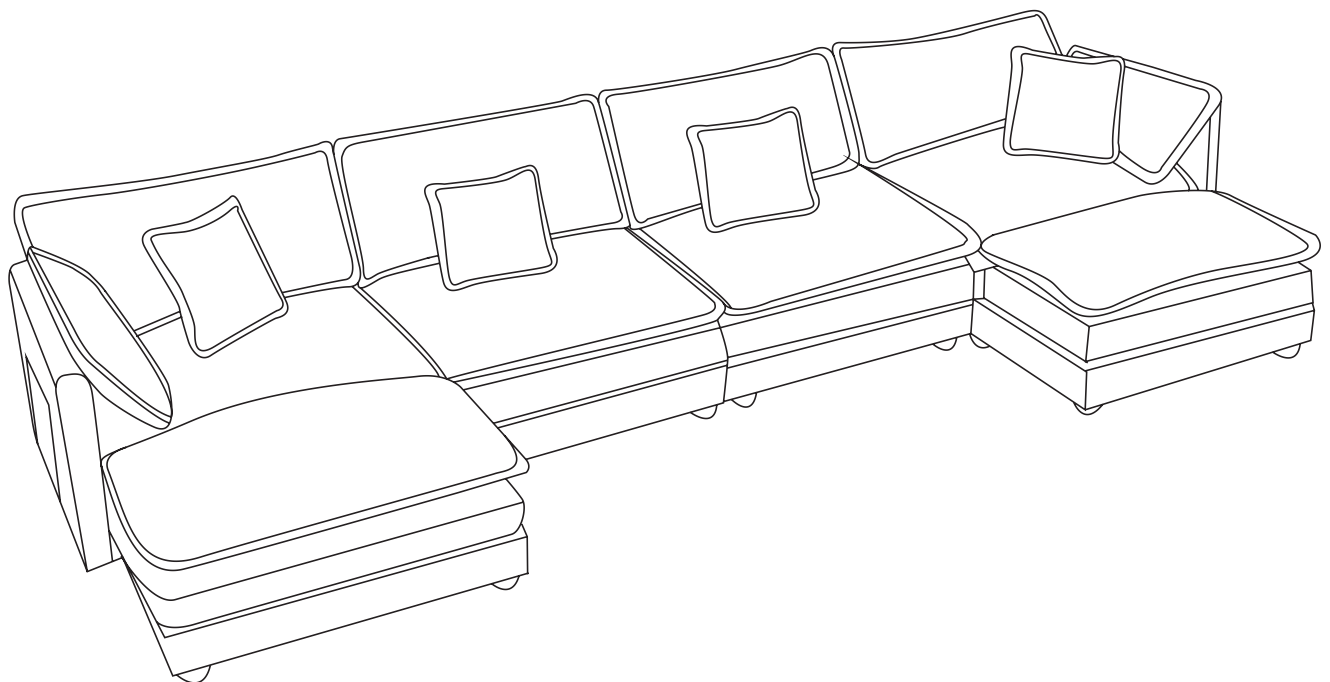

## **Return & Warranty Policy:**

--We strive to offer the highest quality products, and we also try our best to satisfy each and every customer that orders from us with replacement parts/or service as needed.

--If the item is damaged or defective, please take photos as evidence for replacements and refunds .

--Please do not return to store, contact the seller if you have any trouble with this product .





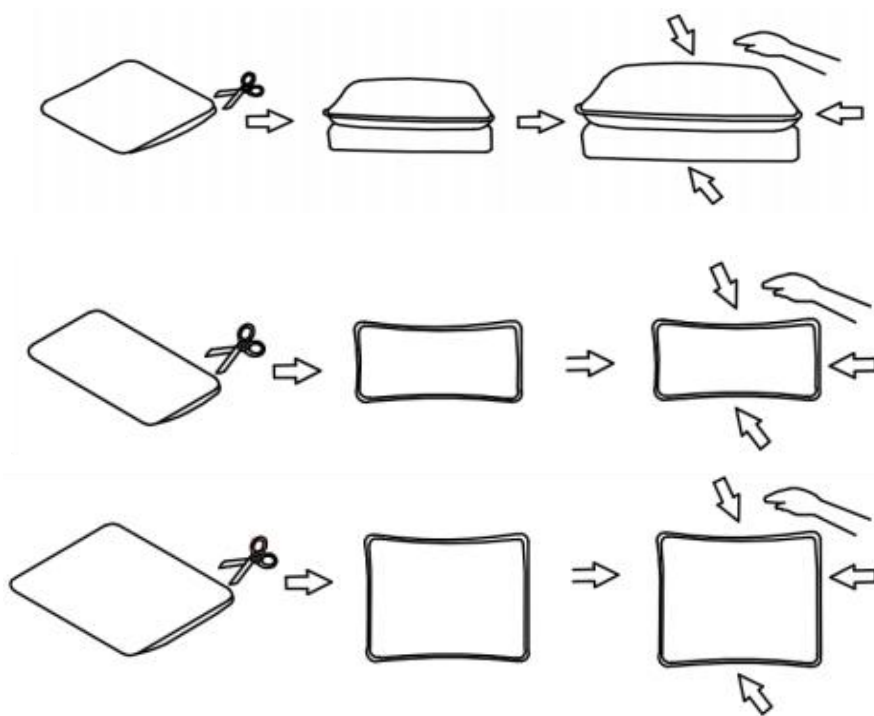





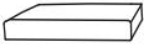

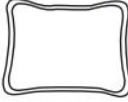
## TIPS:

1. Some key parts of your product may be stored and hidden inside of other parts. Please open any zippered or hook & loop storage compartments to remove all parts. (example: cushions and legs being stored in the under side of a sofa)
2. This product contains small components. Please ensure that they are kept away from small children.
3. Do not use power tools to assemble your furniture. Power tools may strip or damage the parts.
4. The cushion is packaged by vacuum compression. After cutting the package, it rebounds quickly within 4 hours. If the fabric has wrinkles, it will basically disappear after standing for 72 hours.













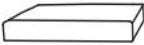

# Please follow below assembly instruction

## Parts List

<b>A</b> Seat frame  2PCS	<b>B</b> Seat cushion  2PCS	<b>C</b> Back Cushion  2PCS	<b>D</b> Arm Pillow  2PCS	<b>E</b> Pillow  2PCS
<b>F</b> Backrest  2PCS	<b>G</b> Leg  8PCS	<b>L</b> Gasket  8PCS	<b>N</b> Washer  24 PCS	<b>O</b> M8*60mm Bolt  8PCS
<b>P</b> M8*80mm Bolt  8PCS	<b>Q</b> Butterfly Nut  8PCS	<b>R</b> Alley Key  2PCS		

---

## Parts List

<b>A</b> Seat frame  1PC	<b>B</b> Seat cushion  1PC	<b>C</b> Back Cushion  1PC	<b>E</b> Pillow  1PC	<b>F</b> Backrest  1PC
<b>G</b> Leg  4PC	<b>L</b> Gasket  4PCS	<b>N</b> Washer  12PCS	<b>O</b> M8*60mm Bolt  4PCS	<b>P</b> M8*80mm Bolt  4PCS
<b>Q</b> Butterfly Nut  4PCS	<b>R</b> Alley Key  1PC			

# PART LIST & HARDWARE

## Parts List

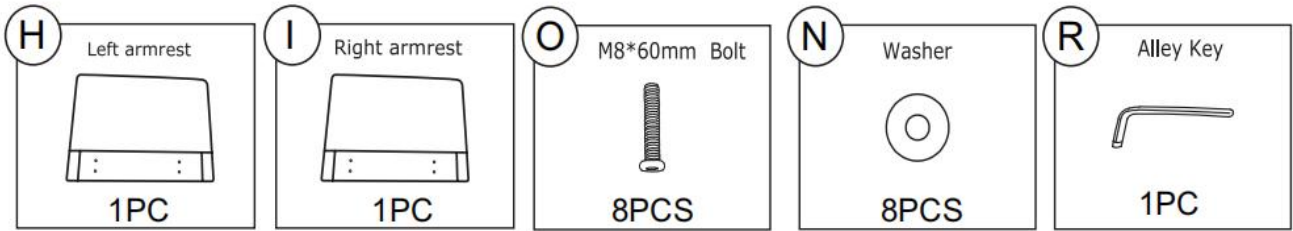

## Parts List

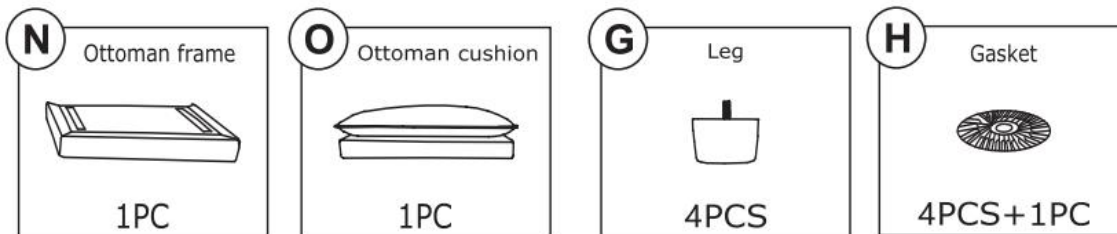

**Note:** Please retain all boxes until you are certain that your product isn't damaged and that you do not wish to return it. Disposal of boxes may prevent our ability to resolve your request.

# ASSEMBLY STEPS

## 1-Seater Sofa

**STEP 1:** Assemble the Left armrest (H) and the Right armrest (I) to the Seat frame (A) with Washers (N) and Bolts (O).

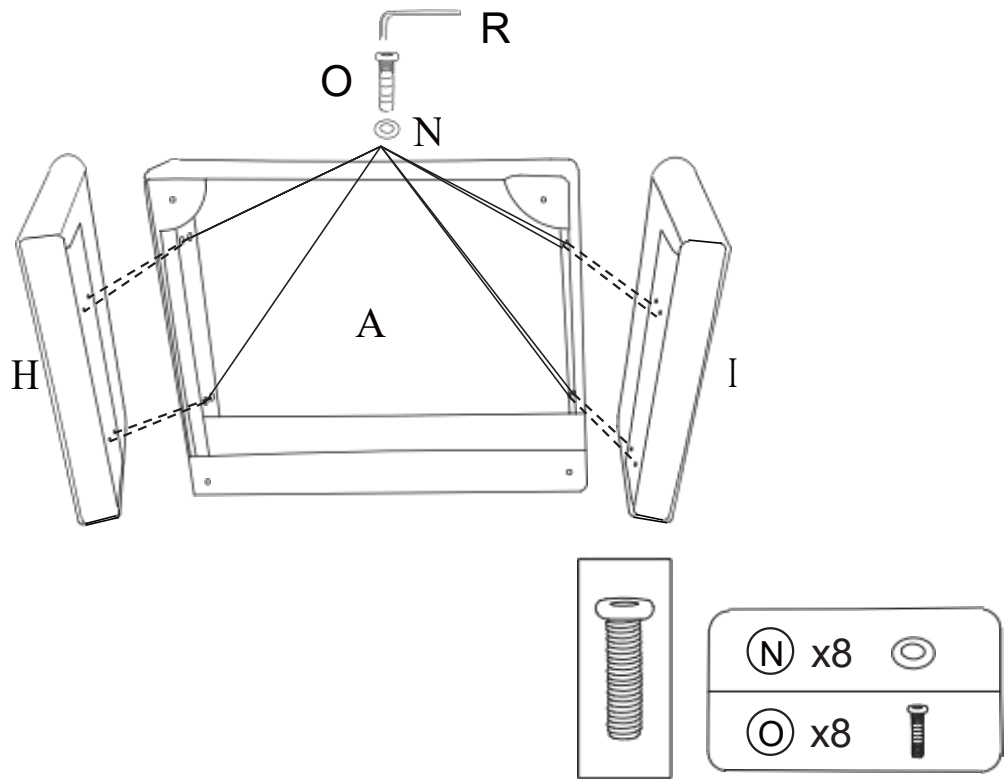

**STEP 2 :** Assemble the Legs (G) on the sofa with Gaskets ( L).

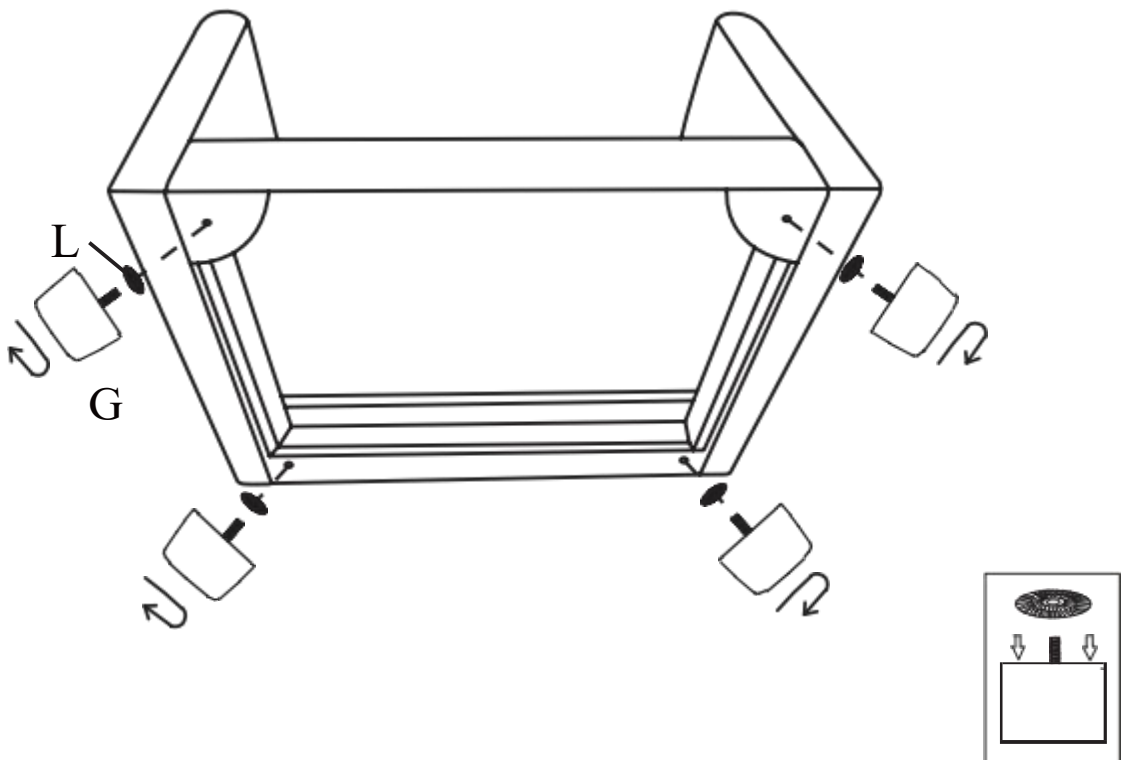

**STEP 3:** Insert the Backrest (F) into the designated holes, using Washer (N) and Bolts (O) to 70% tightness, and then tighten the all Bolts on the seat.

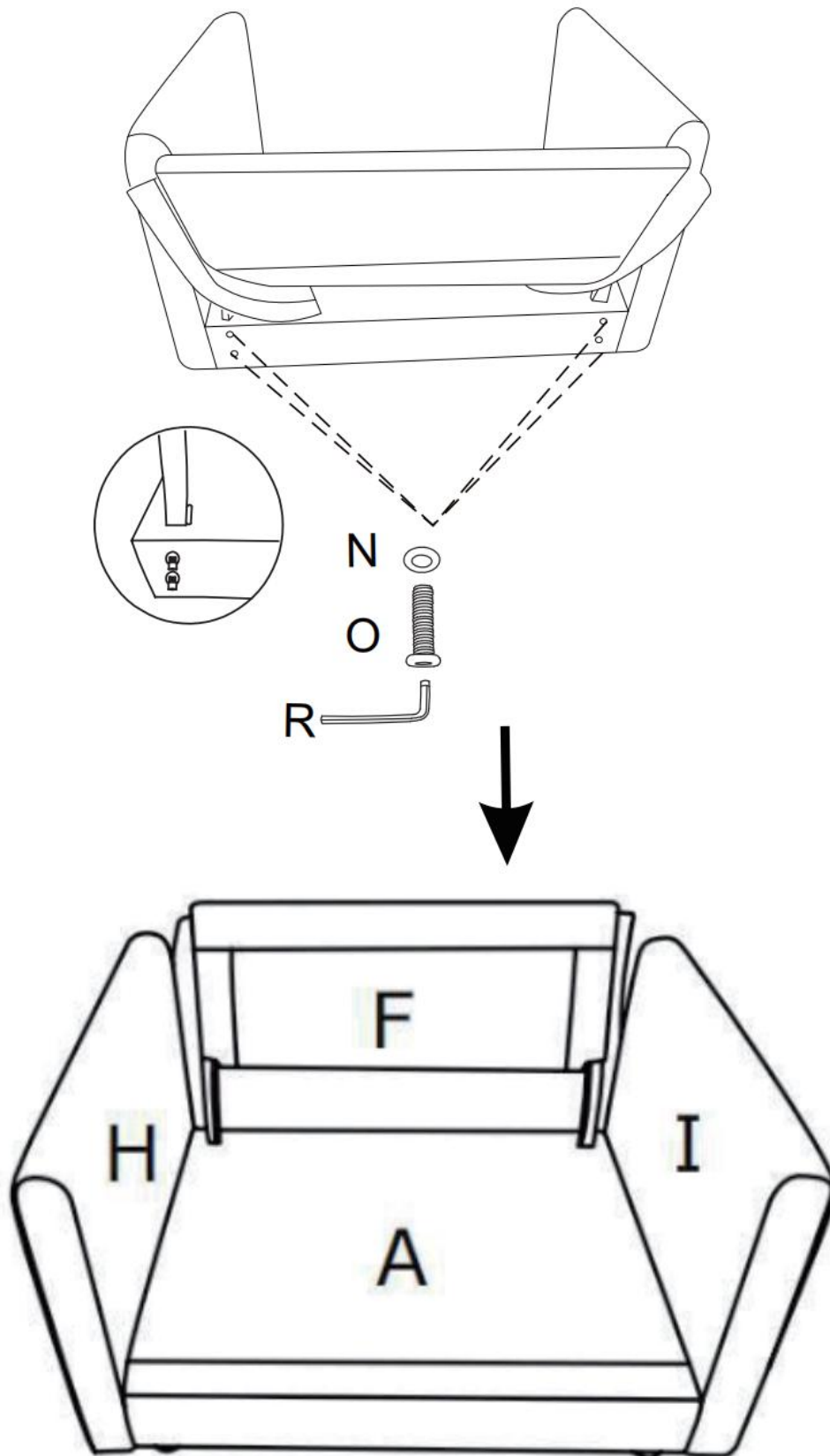

**STEP 4:** Place Seat cushion (B) and back cushion (C), and pillow (E) on sofa and make sure it's well fitted.

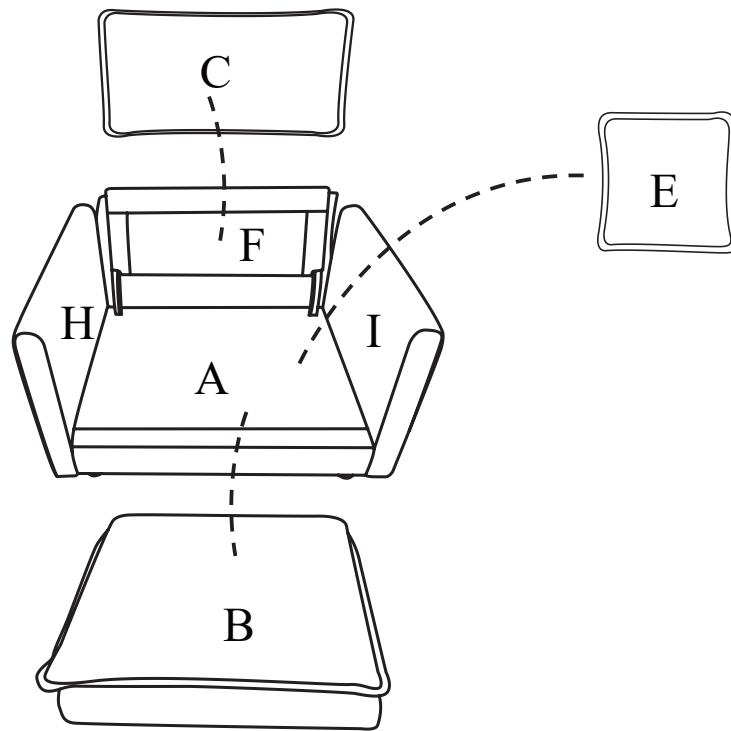

**STEP 5:** Well done!! You can enjoy your leisure time on the sofa now .

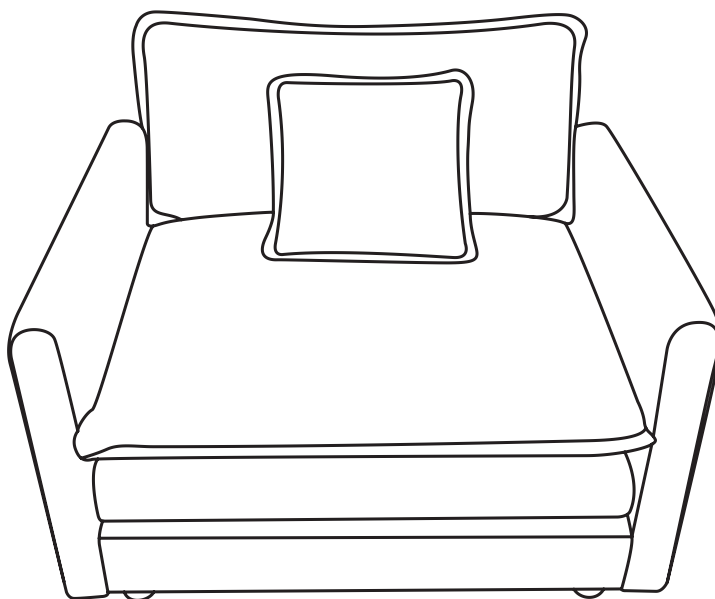

# ASSEMBLY STEPS

## 2-Seater Sofa

**STEP 1:** Assemble the Left armrest (H) to the Seat frame (A) with Washers (N) and Bolts (O).

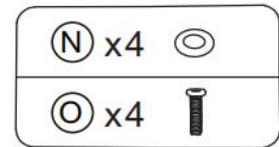
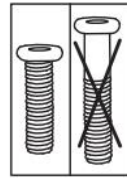
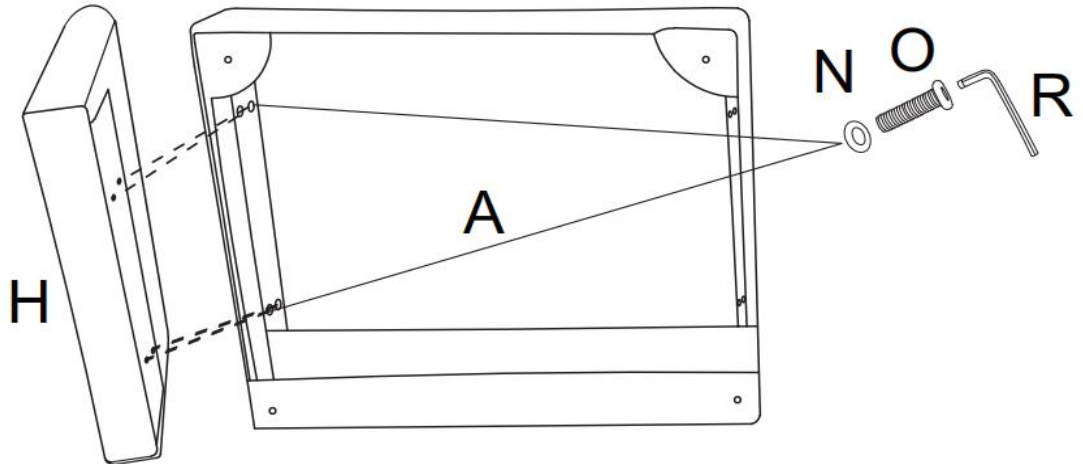

**STEP 2:** Assemble the Right armrest (I) to the Seat frame (A) with Washers (N) and Bolts (O).

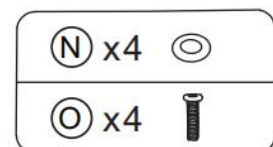
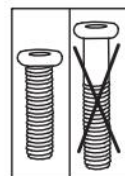
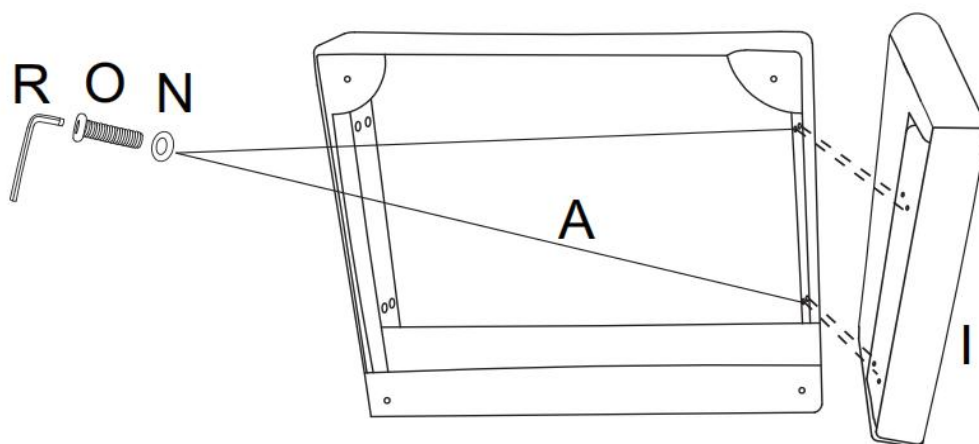

**STEP 3:** Assemble Seat frame (A) and Seat frame (A) with Butterfly nuts ( Q ) Washers ( N ) and Bolts ( P ).

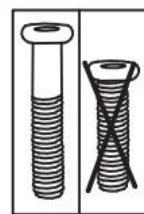
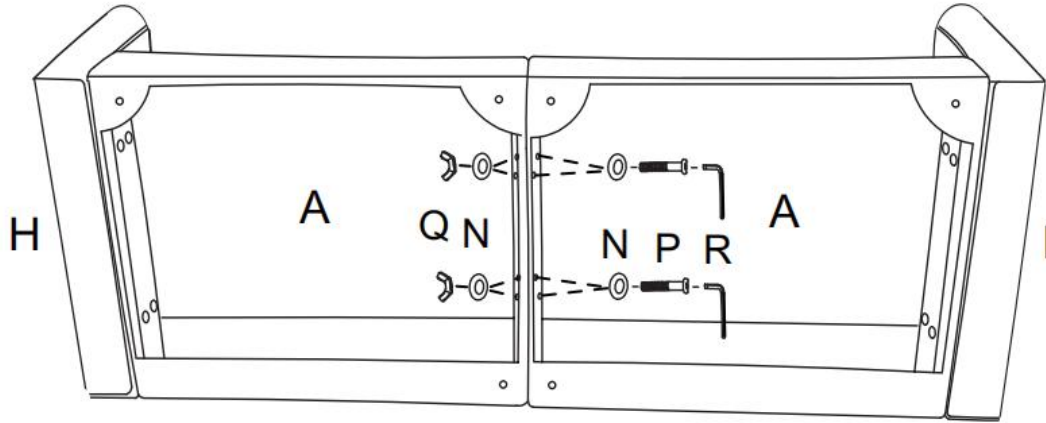

(N) 8	
(P) x 4	
(Q) x 4	

**STEP 4:** Assemble the Legs ( G ) on the sofa with Gaskets ( L ).

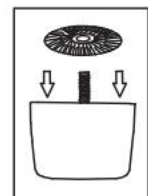
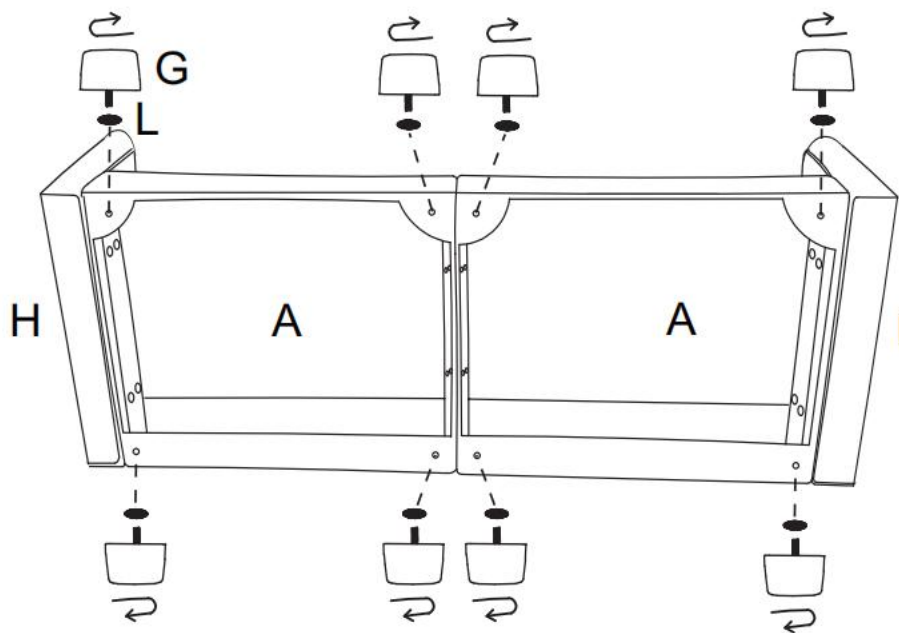

**STEP 5:** Insert the Backrest (F) into the designated holes, using Washer (N) and Bolt (O) to 70% tightness, and then tighten the all Bolts on the seat.

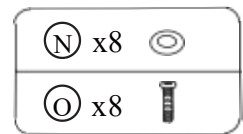
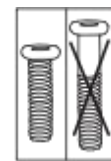
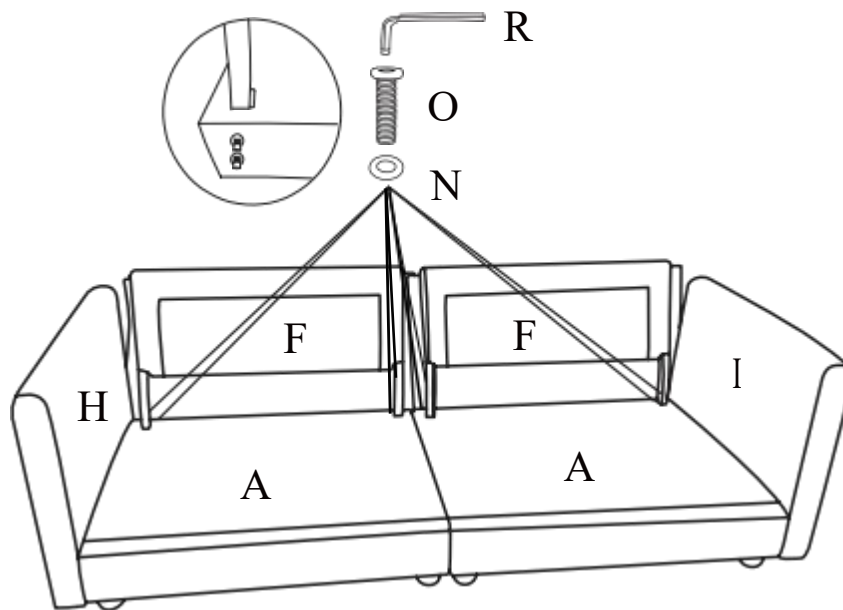

**STEP 6:** Place Seat cushions (B) and back cushions (C), on the sofa and make sure it's well fitted.

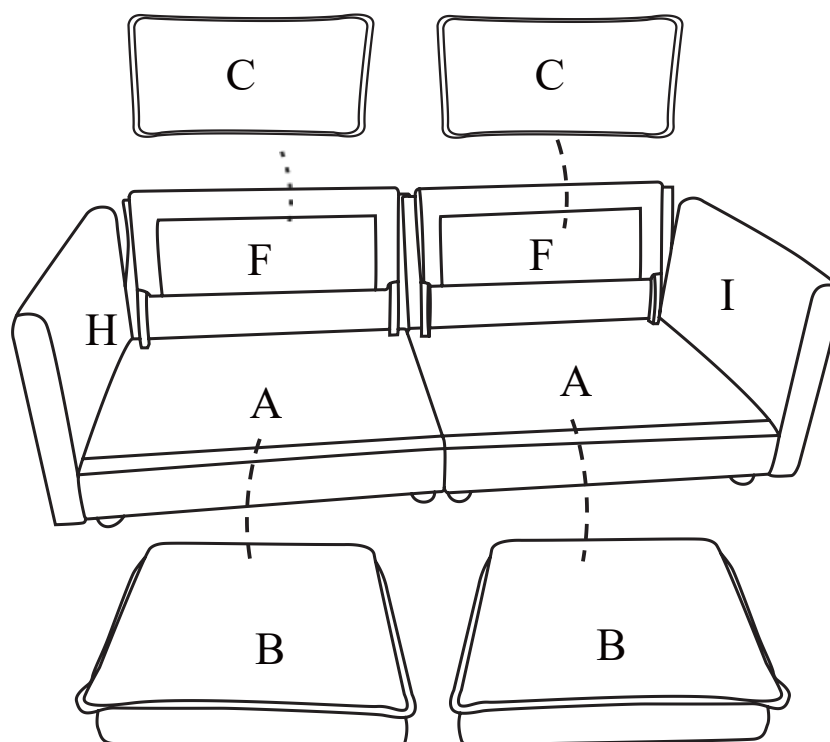

**STEP 7:** Place Pillows (E) and Pillows (D) on sofa and make sure it's well fitted.

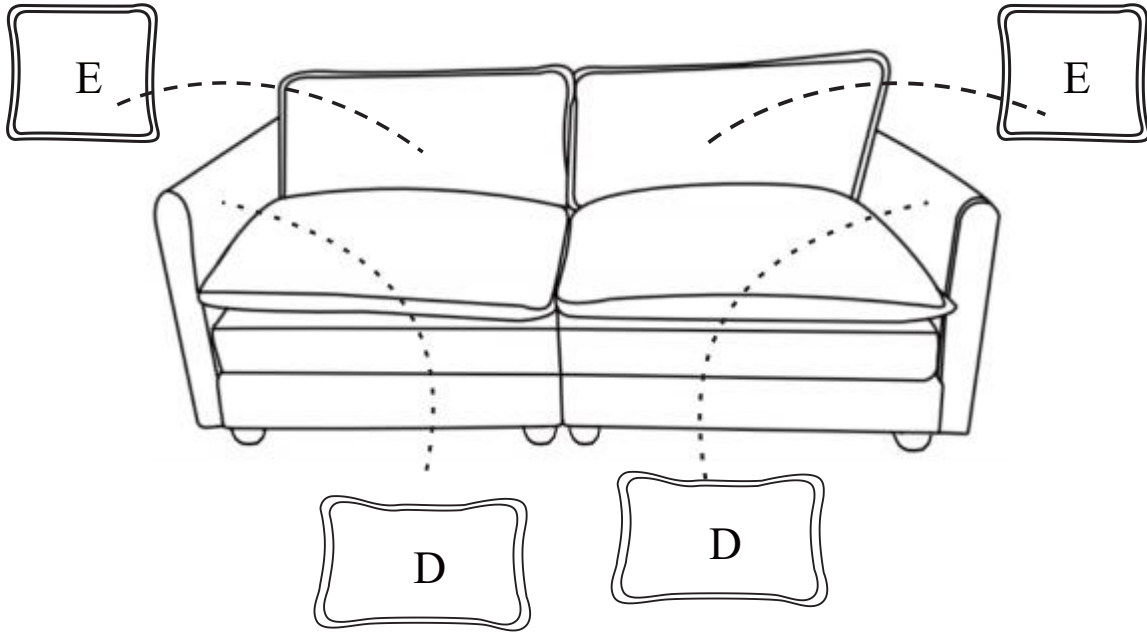

**STEP 8 :** Well done!! You can enjoy your leisure time on the sofa now .

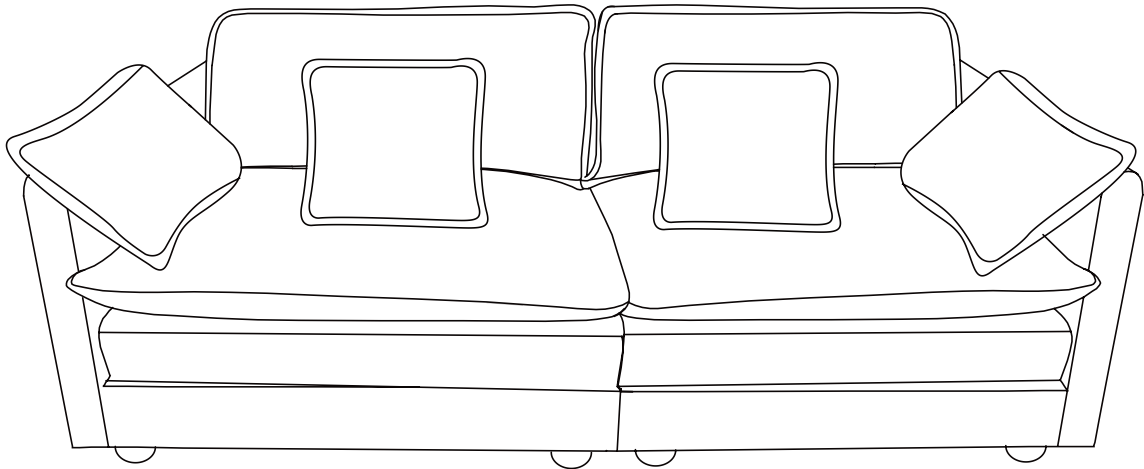

# ASSEMBLY STEPS

## 3-Seater Sofa

**STEP 1:** Assemble the Left armrest (H) to the Seat frame (A) with Washers (N) and Bolts (O).

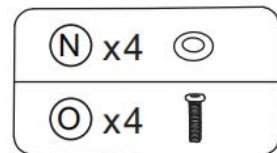
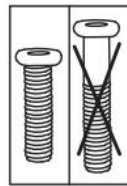
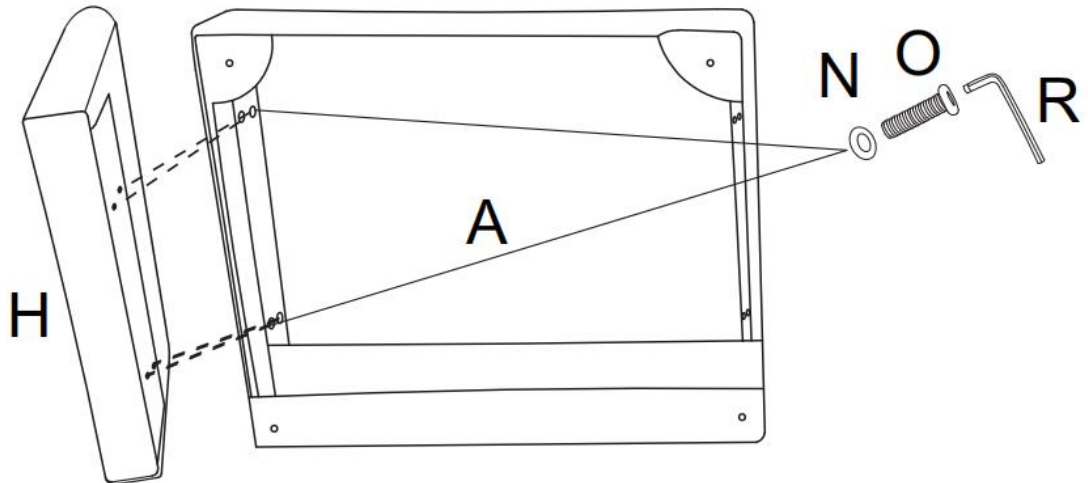

**STEP 2:** Assemble the Right armrest (I) to the Seat frame (A) with Washers (N) and Bolts (O).

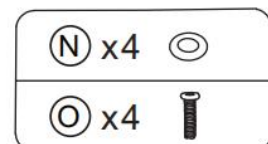
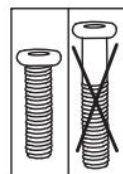
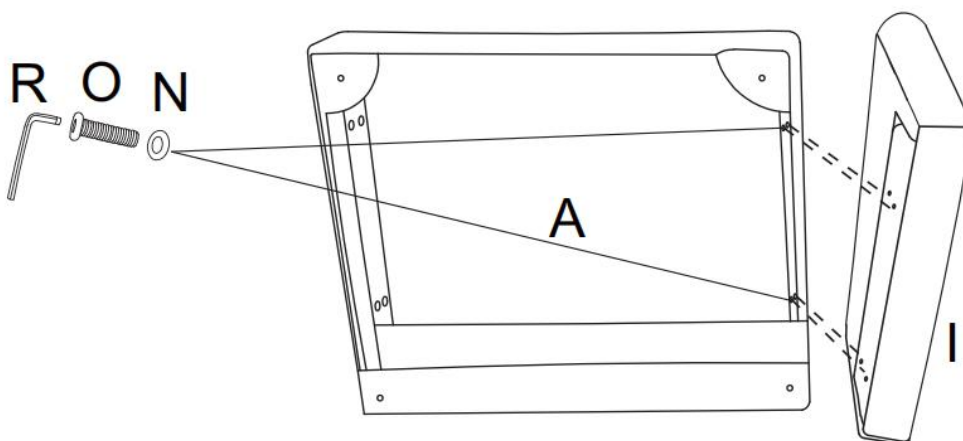

**STEP 3:** Assemble Seat frame (A) and Seat frame (A)with Butterfly nuts (Q) Washers(N) and Bolts ( P).

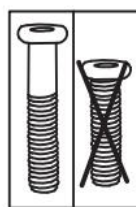
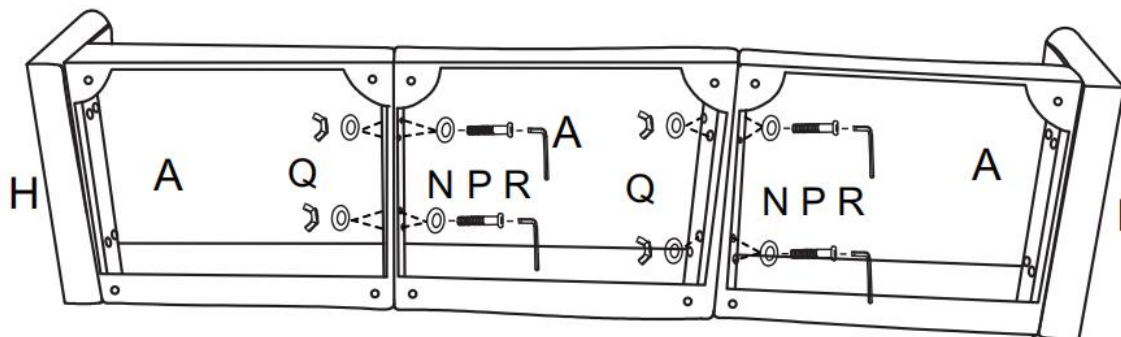

(N) x 16	
(P) x 8	
(Q) x 8	

**STEP 4:** Assemble the Legs (G) on the sofa with Gaskets (L).

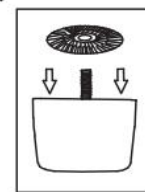
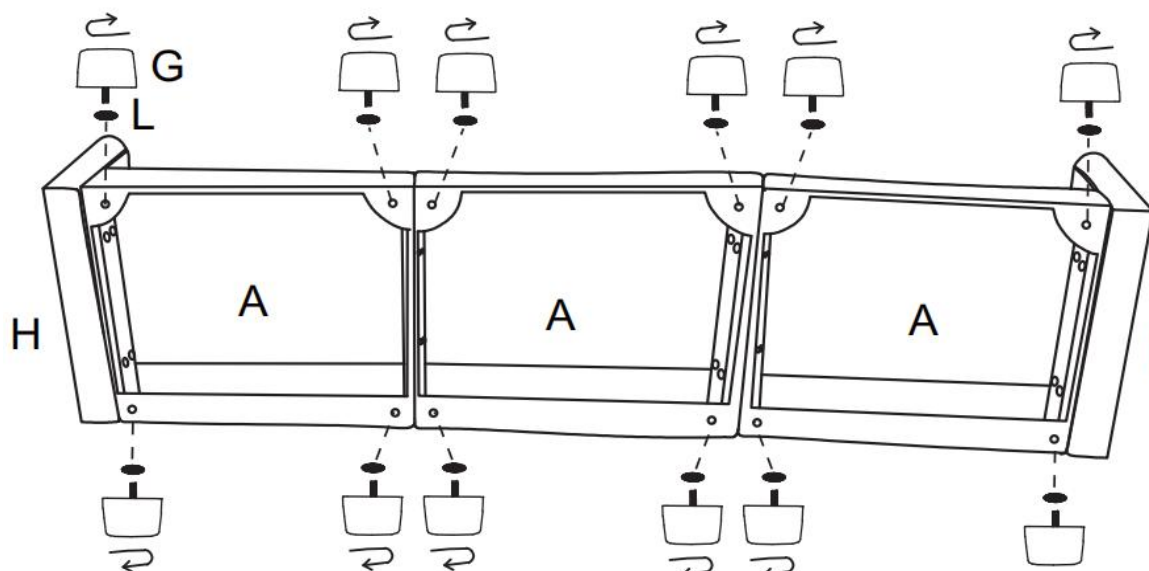

**STEP 5:** Insert the Backrest (F) into the designated holes, using Washer (N) and Bolts (O) to 70% tightness, and then tighten the all Bolts on the seat.

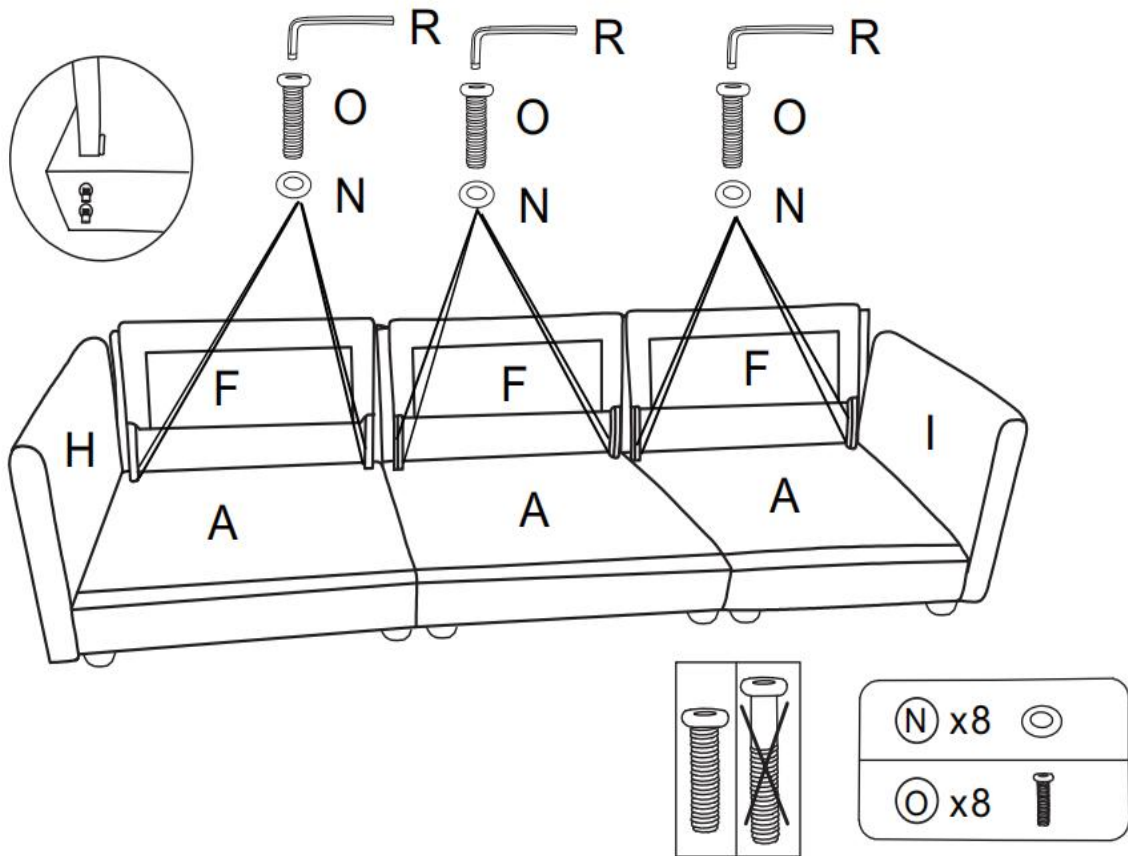

**STEP 6 :** Place Seat cushions (B) and back cushions (C), and make sure it's well fitted.

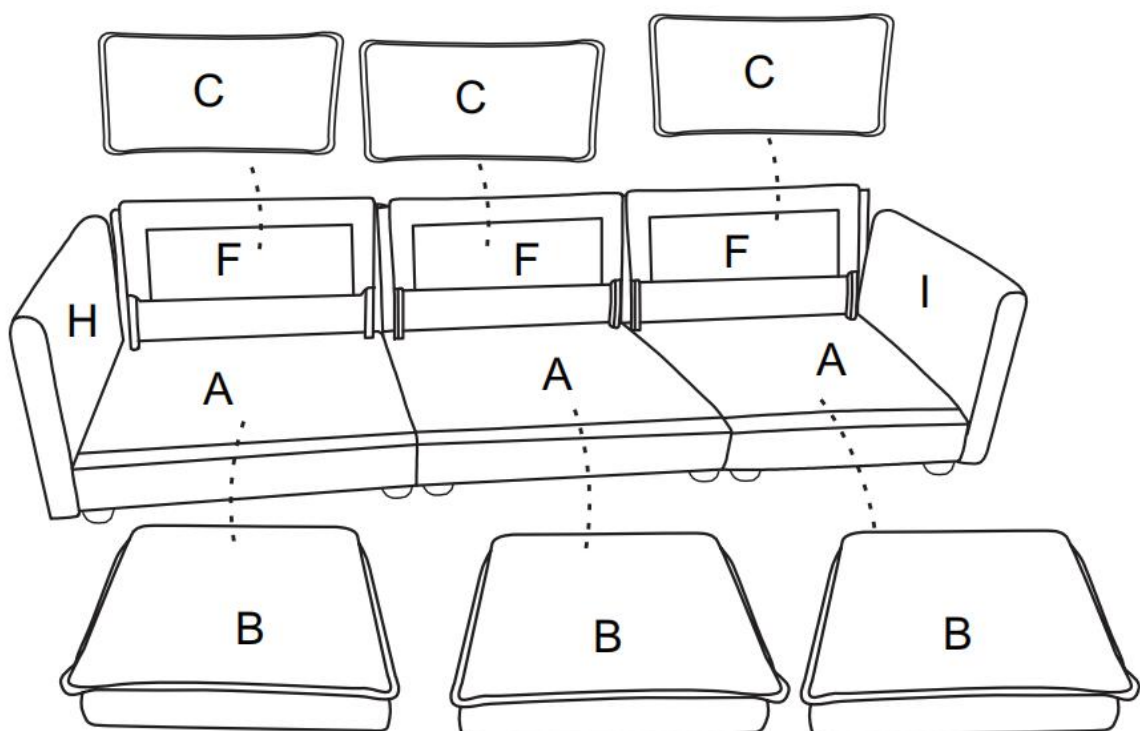

**STEP 7 :** Place Pillows(E) and Pillows (D) on sofa and make sure it's well fitted.

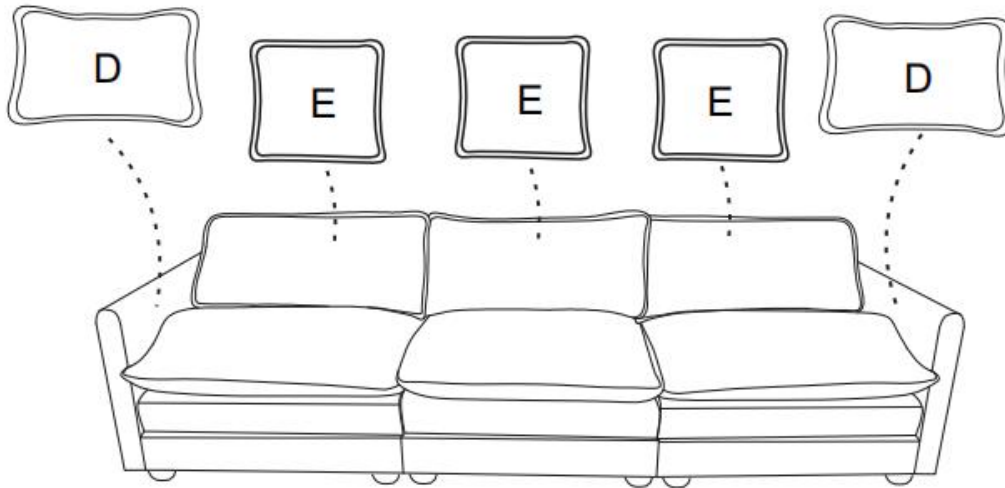

**STEP 8 :** Well done!! You can enjoy your leisure time on the sofa now .

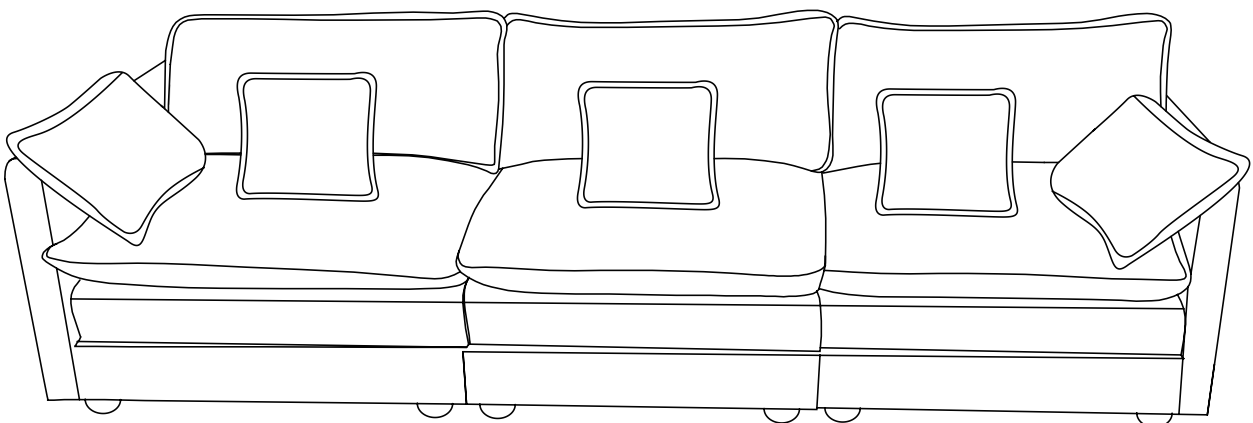

# ASSEMBLY STEPS

## 4-Seater Sofa

**STEP 1:** Assemble the Left armrest (H) to the Seat frame (A) with Washers (N) and Bolts (O).

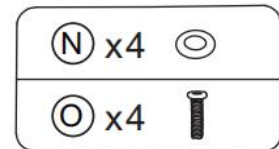
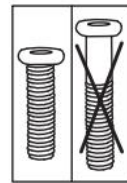
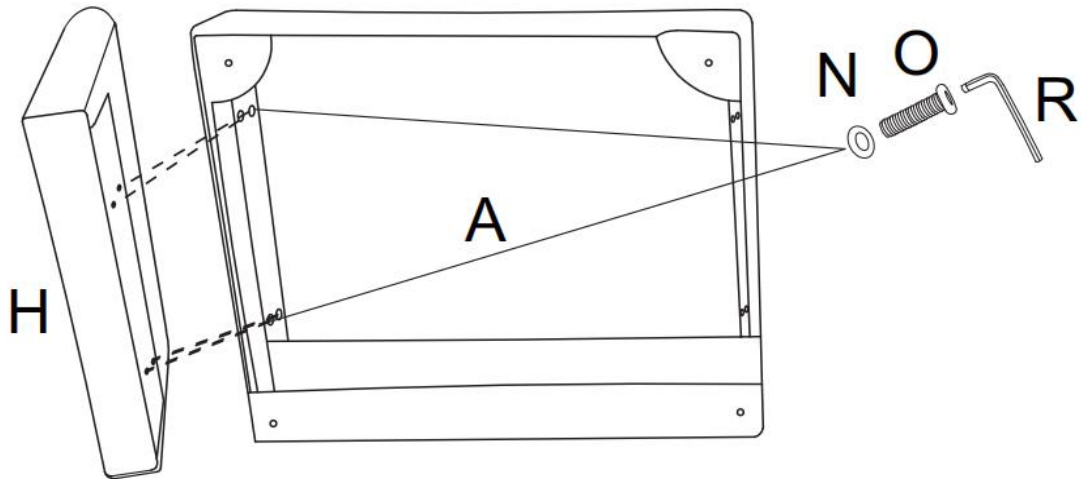

**STEP 2:** Assemble the Right armrest (I) to the Seat frame (A) with Washers (N) and Bolts (O).

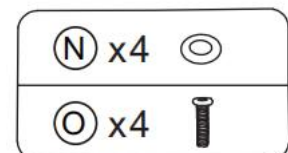
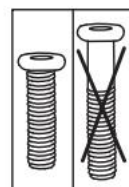
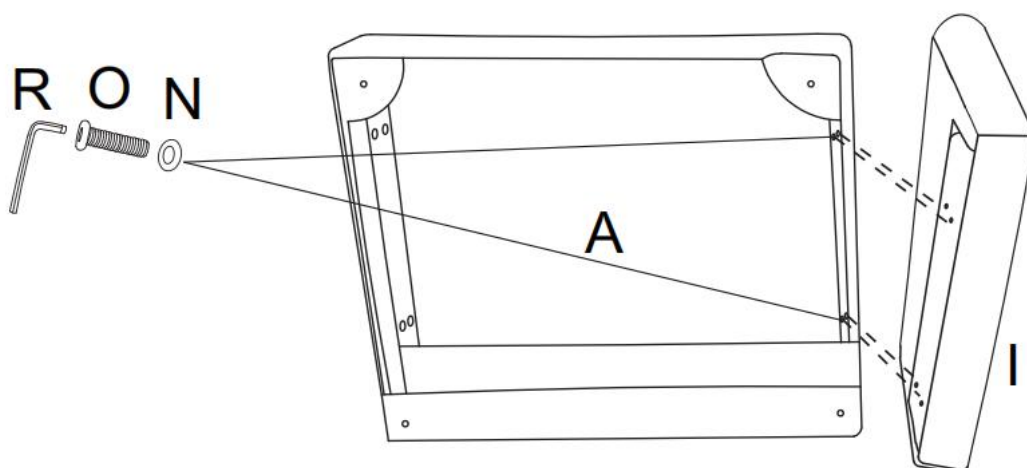

**STEP 3:** Assemble Seat frame (A) and Seat frame (A) with Butterfly nuts (Q) Washers (N) and Bolts (P).

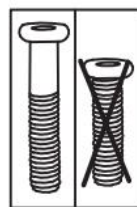
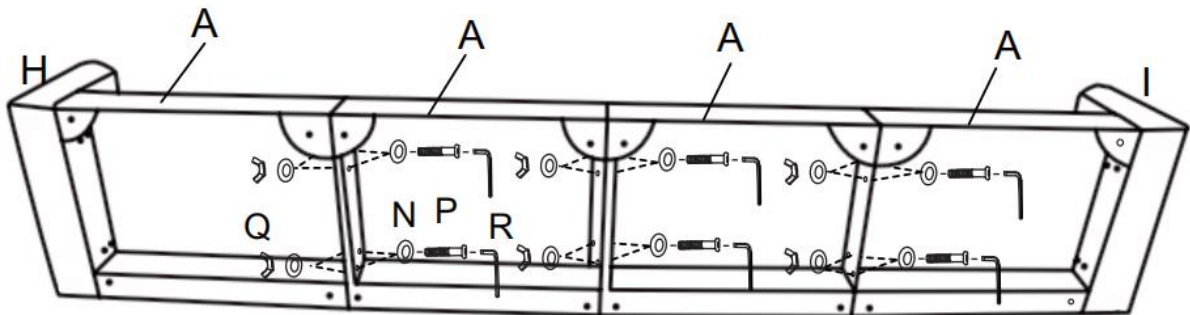

(N) x 24	
(P) x 12	
(Q) x 12	

**STEP 4:** Assemble the Legs (G) on the sofa with Gaskets (L).

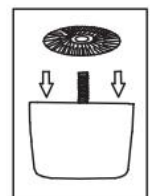
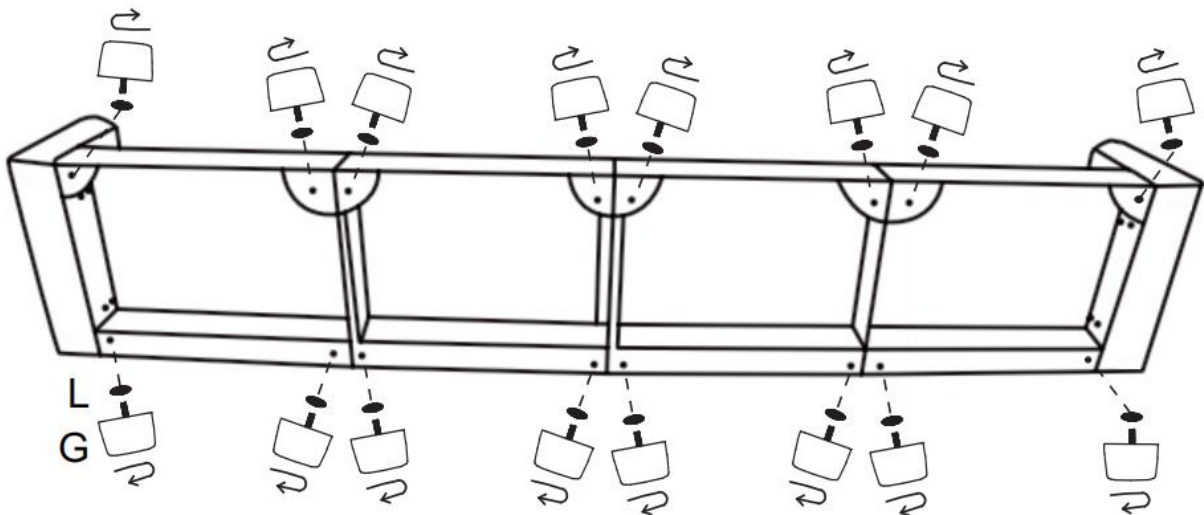

**STEP 5:** Insert the Backrest (F) into the designated holes, using Washer (N) and Bolts (O) to 70% tightness, and then tighten the all Bolts on the seat.

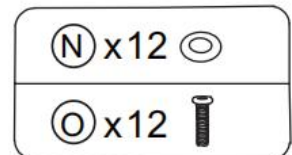
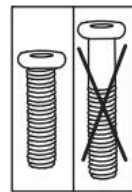
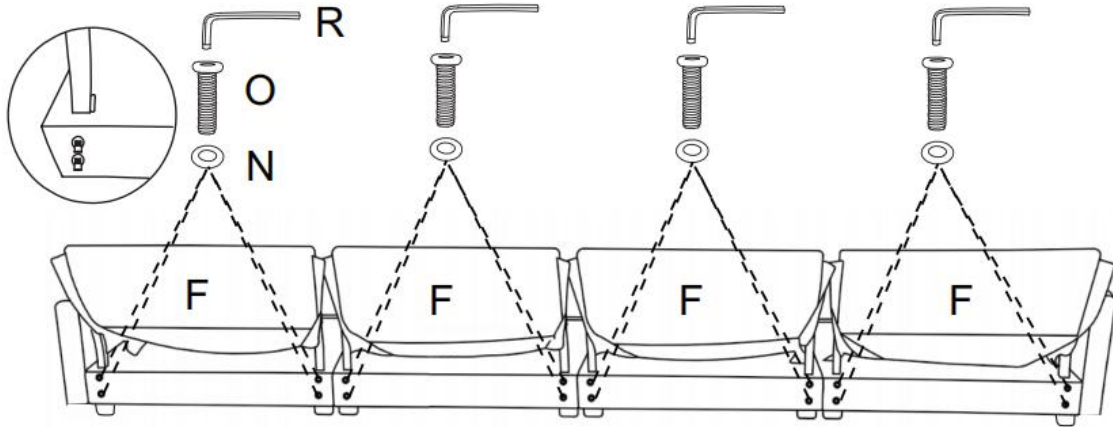

**STEP 6 :** Place Seat cushions (B) and back cushions (C), and make sure it's well fitted.

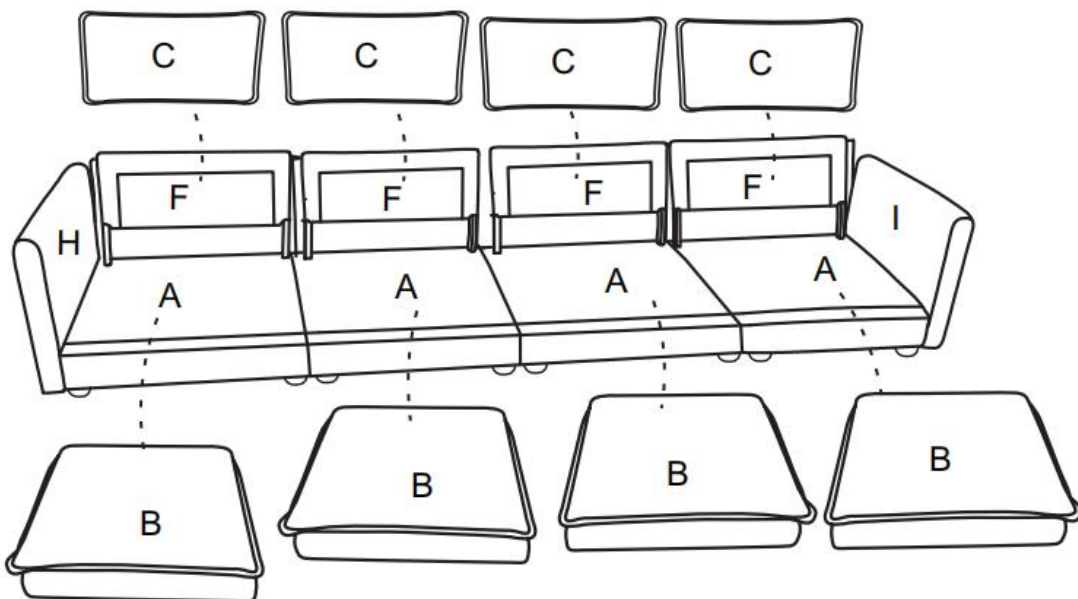

**STEP 7 :** Place Pillows (E) and Pillows (D) on sofa and make sure it's well fitted.

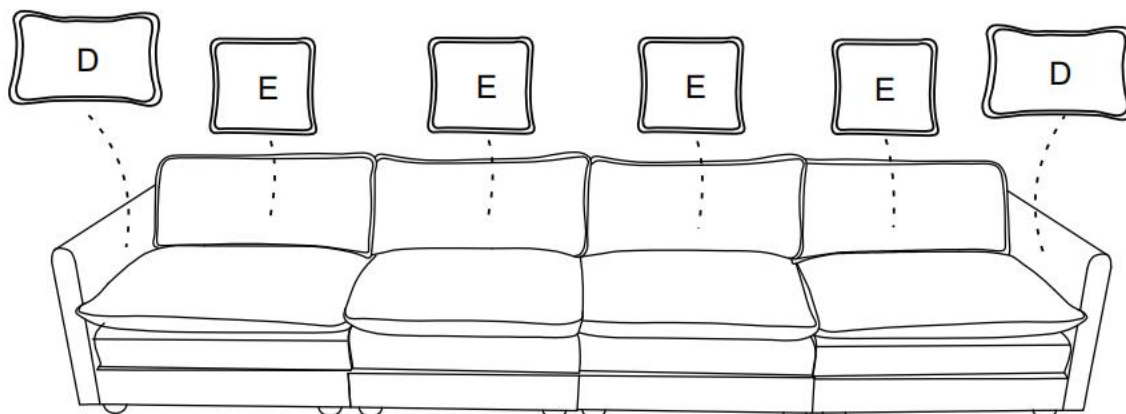

**STEP 8 :** Well done!! You can enjoy your leisure time on the sofa now .

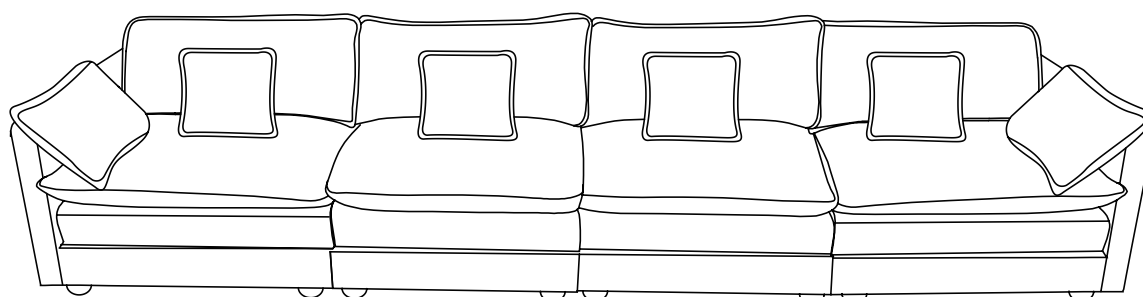

# ASSEMBLY STEPS

## 1-ottoman

**STEP 1:** Assemble the Legs(G) on the ottoman frame with Gaskets (H).

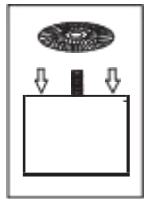
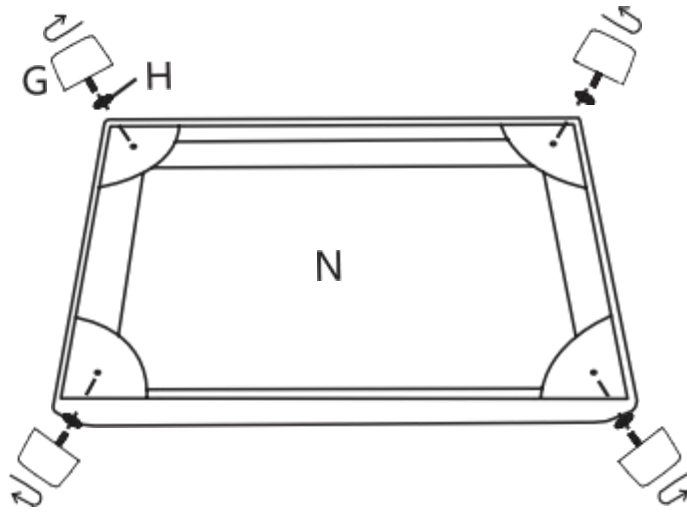

**STEP2 :**Place seat ottoman cushion (O) on the ottoman frame(H).

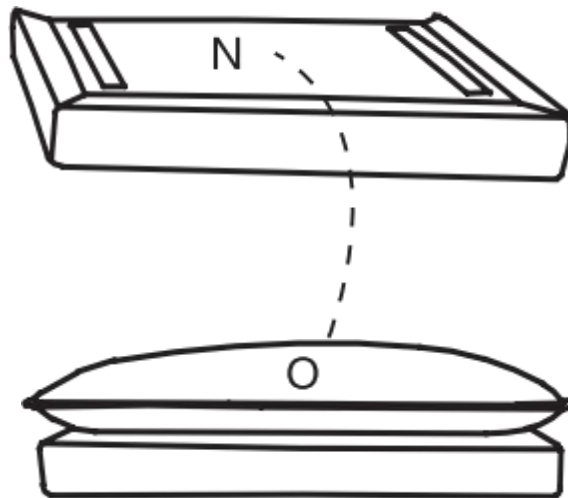

**STEP 3 :** Well done!! You can enjoy your leisure time on the sofa now .

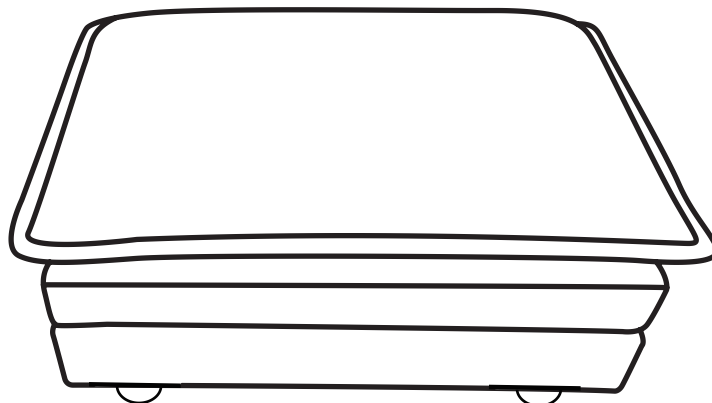

# NOTE

This sofa set comes with individual modules, including a single sofa, a 2-seater sofa and an ottoman, you can purchase additional modules according to your living room size.

Below are some configuration options for your reference.

