

Sofa Bed Instruction

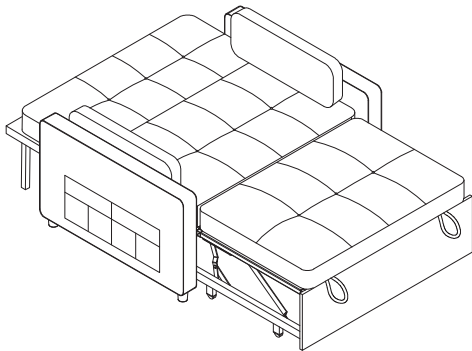

STORAGE BED FRAME

The product comes in 2 BOXES. Do not proceed with unpacking or assembly until both boxes are received.

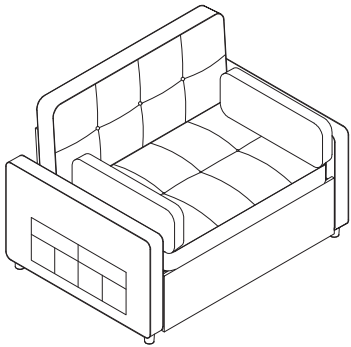

- To prevent the hardware package from being lost, a special loss-prevention cord is included. Use it to locate the hardware package.

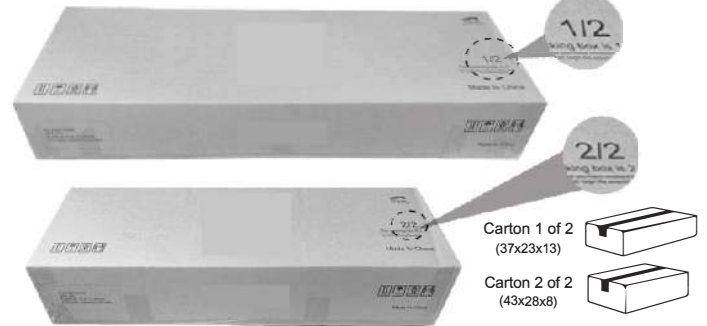

- Box identification is shown in the location indicated in the picture on the left of the outer box. The assembly guide and accessory box (including hardware, socket, lamp, and remote) are in box 2/2. Please locate all accessories from both boxes before assembly.

CUSTOMER SERVICE GUIDE

Thank you for choosing our product! We are committed to providing you with excellent service. If you find any missing parts, damaged packaging, or product damage after receiving all packages, please follow the steps below to quickly contact our customer service team. We will do our best to resolve your issue.

1. Missing Parts

Verify Parts:

1. Refer to the "Parts List" in the manual (see page 3) to verify the name, specifications, and quantity of the missing parts.
2. Take a clear photo of the parts list and mark the missing parts with detailed information, e.g., "Missing 5 pieces of M6X30mm screws."

Contact Us:

- By Email:
Send an email to us, with the subject line "Missing Parts Issue." Include the following in the email:
 - A description of the missing parts and a photo of the parts list.
 - Order details (order number, purchase platform, purchase date).

2. Product or Packaging Damage

If it affects normal use:

Steps:

1. Take clear photos or videos showing the damaged parts and the extent of the damage (multiangle shots are recommended).
2. Email the photos/videos along with order details to us, with the subject line "Product Damage Issue."

Resolution:

After verification, we will arrange for a replacement part, product exchange, or refund as quickly as possible.

If it does not affect normal use:

Steps:

1. Contact our customer service team.
2. Provide a description of the damage and include relevant photos or videos.

Resolution:

We will provide repair guidance or an appropriate compensation plan based on the specific situation.

Helpful Tips

To process your issue efficiently, please prepare the following information:

- Order details (order number, purchase platform, purchase date).
- Clear photos or videos.
- We are committed to providing quick and professional solutions, no matter the size of the issue, to ensure your satisfaction.

Thank you for your trust and support! We hope you enjoy using our product!

IMPORTANT/WICHTIG/ATENCIÓN IMPORTANT/IMPORTANTE



EN - We recommend **1** or more people to install.
DE - Wir empfehlen, dass die Montage von **1** oder mehreren Personen durchgeführt werden sollte.
ES - **Recomendamos realizar el ensamble con 1 o más personas.**
FR - Il est recommandé d'effectuer le montage à **1** personne(s) ou plus.
IT - È necessaria la presenza di **1** o più persone per il montaggio di questo prodotto.



EN - The expected assembly time is **1 h.**
DE - Die Montagezeit beträgt durchschnittlich **1 h.**
ES - El tiempo aproximado de ensamble es de **1 h.**
FR - Le temps nécessaire est estimé à **1 h.**
IT - Il tempo previsto per il corretto assemblaggio è di **1 h.**



EN - Not intended for use by children.
DE - **Nicht geeignet für Kinder.**
ES - Producto no apto para niños.
FR - **Produit non destiné à être utilisé par des enfants.**
IT - Questo prodotto non è destinato all'uso da parte dei bambini.



EN - Keep away from fire or other heat sources.
DE - **Bitte von Feuer und Hitzequellen fernhalten.**
ES - Manténgase alejado de las llamas y otras fuentes de calor.
FR - **Tenir à distance des flammes et autres sources de chaleur.**
IT - Tenere lontano dal fuoco o da altre fonti di calore.



EN - We recommend wearing protective gloves.
DE - Wir empfehlen das Tragen von Schutzhandschuhen.
ES - **Recomendamos el uso de guantes de seguridad.**
FR - Il est recommandé de porter des gants de protection.
IT - Per il processo di assemblaggio, consigliamo fortemente l'utilizzo di guanti protettivi.

EN - Please follow the instruction manuals and use a pad to avoid damage during assembly.
DE - Bitte folgen Sie der Anleitung und verwenden Sie eine Unterlage, um Beschädigungen bei der Montage zu vermeiden.
ES - Por favor, siga las instrucciones del manual y utilice una cubierta o lona para proteger el producto y el suelo durante la instalación.
FR - Suivez les instructions de la notice et utilisez une couverture ou une bâche pour protéger le produit et les sols pendant le montage.
IT - Si prega di consultare il manuale illustrativo durante il montaggio e di utilizzare un cuscinetto per evitare possibili danni.

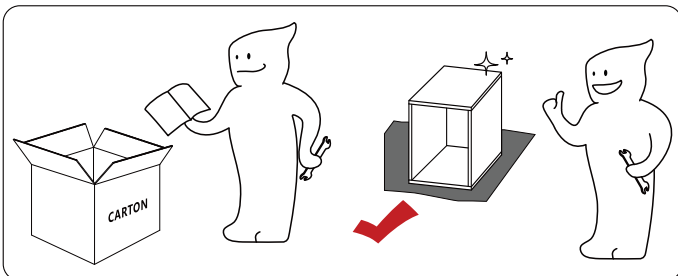
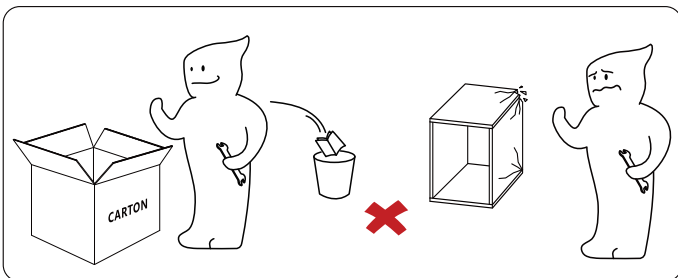
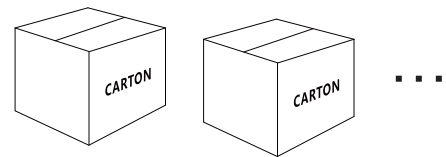

EN-We would request you to confirm receipt of all boxes before initiating assembly since the product has been shipped in multiple packages.

DE-Bitte bestätigen Sie den Erhalt aller Packungen, bevor Sie den Zusammenbau beginnen, da das Produkt in mehreren Paketen versendet wird.

ES -Le pediríamos que confirme la recepción de todas las cajas antes de iniciar el montaje, ya que el producto se ha enviado en varios paquetes.

FR-Nous vous prions de confirmer la réception de toutes les boîtes avant de commencer le montage, car le produit a été expédié en plusieurs colis.

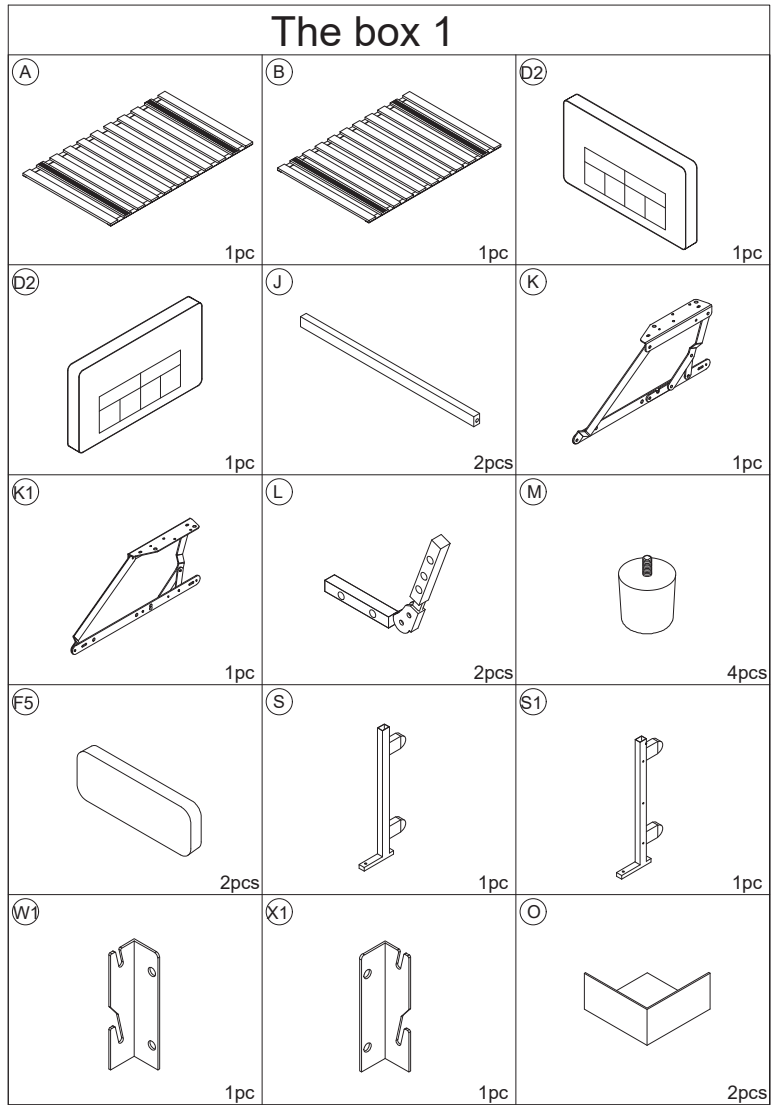
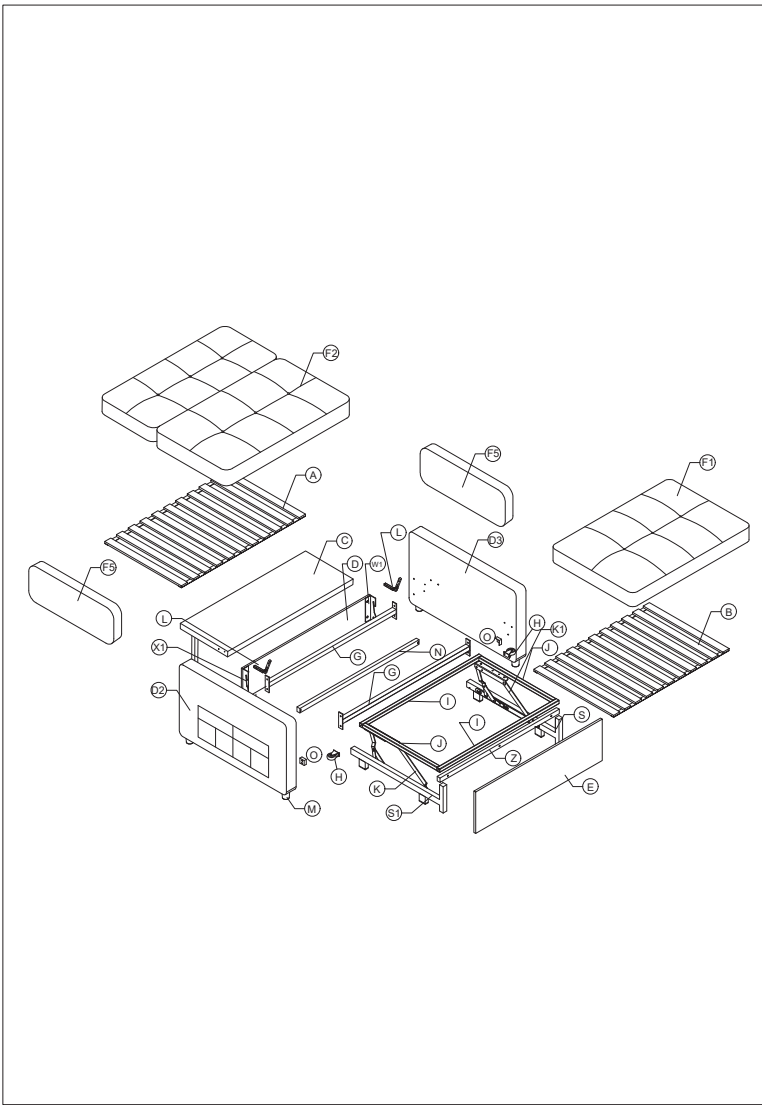

IT -Si prega di confermare di aver ricevuto tutte le scatole prima di iniziare il montaggio, poiché il prodotto viene spedito in diversi imballaggi.







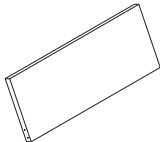
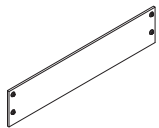
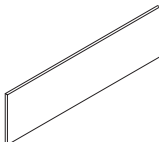
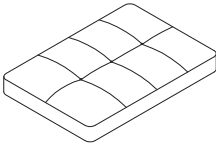
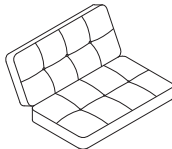
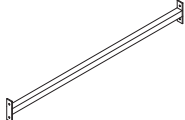
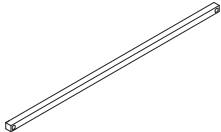
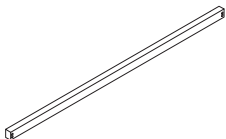
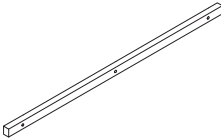

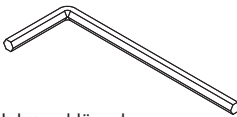

The box 1 continued

 <p>1pc</p>		

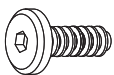
The box 2

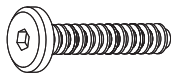
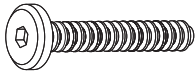
 <p>1pc</p>	 <p>1pc</p>	 <p>1pc</p>
 <p>1pc</p>	 <p>1pc</p>	 <p>2pcs</p>
 <p>2pcs</p>	 <p>1pc</p>	 <p>1pc</p>
 <p>2pcs</p>		

The box 1 continued

<p>①</p>  <p>Schraube M6X15mm</p> <p>10pcs</p>	<p>②</p>  <p>Inbusschlüssel M4</p> <p>1pc</p>	<p>③</p>  <p>Schraube M8X15mm</p> <p>4pcs</p>
<p>④</p>  <p>Schraube M8X20mm</p> <p>16pcs</p>	<p>⑤</p>  <p>Schraube Ø19*8mm</p> <p>45pcs</p>	<p>⑥</p>  <p>Schraube M8X40mm</p> <p>19pcs</p>
<p>⑦</p>  <p>Schraube M8X50mm</p> <p>6pcs</p>	<p>⑧</p>  <p>Schraube M4X10mm</p> <p>4pcs</p>	<p>⑨</p>  <p>Inbusschlüssel M5</p> <p>1pc</p>
<p>⑩</p>  <p>Inbusschlüssel</p> <p>1pc</p>		

10

STEP 1

Attach the feet (M) to the armrest(D2).

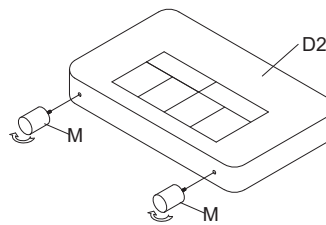

STEP 2

Attach the feet (M) to the armrest (D3).

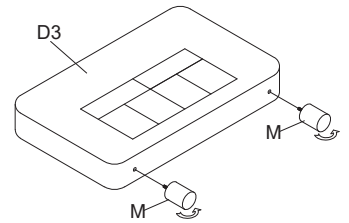



STEP 3

Install the brackets (W1/X1) onto the rear panel(D) using screws (#4).

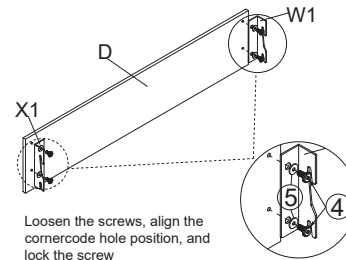
Note: Ensure the hookson W1 and X1 face downward during installation.



Loosen the screws, align the cornercode hole position, and lock the screw



④ 4PCS	⑤ 4PCS
	
M8*20mm	Ø19*8mm

STEP 4

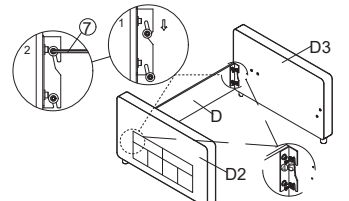
A. Partially screw the screws into the armrests (D2/D3),tightening them to 80%.
B. Hang the brackets on panel (D) onto the screws on the armrests.
C. Fully tighten the screws (#4).



Loosen the screw, hang the cornercode, and lock the screw.

④ 4PCS	⑤ 4PCS
	
M8*20mm	Ø19*8mm

11

STEP 5

Install the hinge (L) onto the backrest (C) using screws (#5).

Note: The non-woven fabric side of the backrest(C) should face up, with the fabric side facing down.

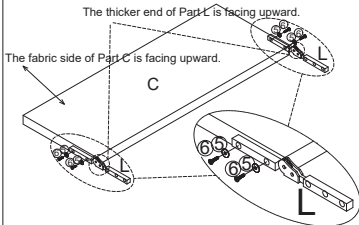

Note: The folding direction of the hinge(L) should face down.

⑥ 4PCS	⑤ 4PCS
M8*30mm	Ø19*8mm

STEP 6

Attach the backrest (C) to the armrests (D2/D3) through the hinge (L) using screws (#7).

Note: Ensure the grooved side of the backrest(C) faces the rear during installation

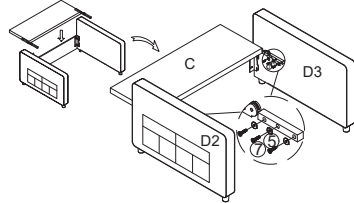

⑦ 6PCS	⑤ 6PCS
M8*50mm	Ø19*8mm

STEP 7

Install the metal rod (G) onto both armrests using screws(#4).

Note: Ensure the rubber side is facing up.

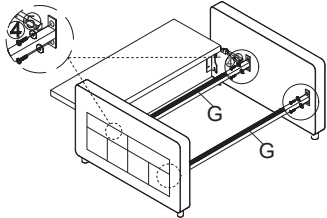

Loosen the screw, align the hole position of the iron frame brace, and lock the screw

④ 8PCS	⑤ 8PCS
M8*20mm	Ø19*8mm

STEP 8

A. Attach the slats (A) onto the two metal rods (G).
B. Install the stoppers (O) onto both armrests using screws(#3).

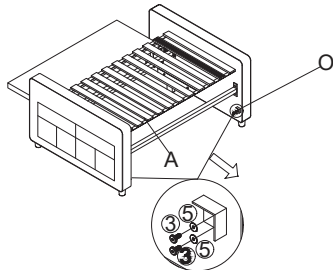

③ 4PCS	⑤ 4PCS
M8*15mm	Ø19*8mm

STEP 9

Place the seat cushion (F2) onto the slats securing it with Velcro

Secure it in place using Nylon Fastener

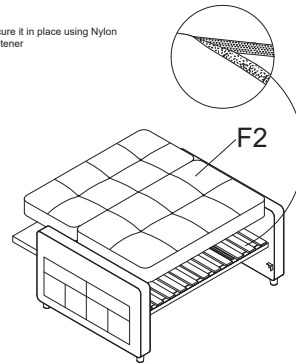

STEP 10

The sofa backrest can be adjusted to different angles.

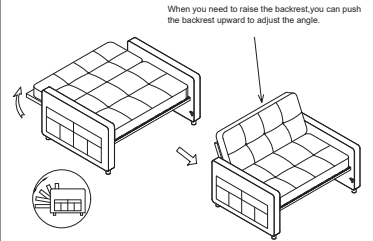

STEP 11

Adjust the backrest angle between 90° and 180°

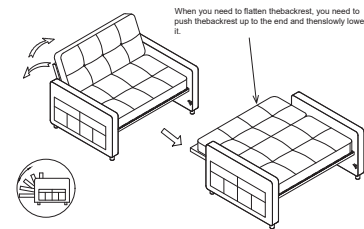

STEP 12

As shown in the diagram, press the switch to extend the sofa legs on the backrest.

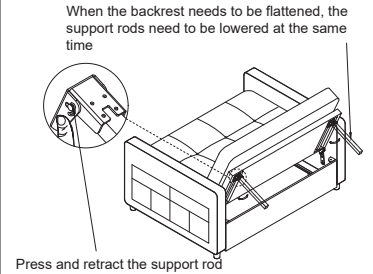

Press and retract the support rod

STEP 13

As shown in the diagram, press the switch to retract the sofa legs on the backrest.

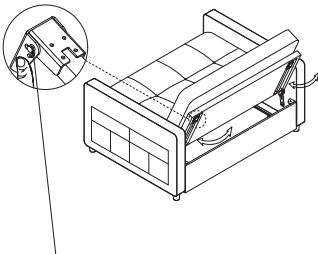

Press and retract the support rod

STEP 14

Connect the part (Z) to part (E) using screws (#6).

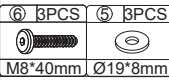
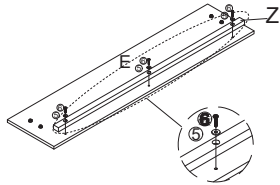

STEP 15

A. Connect parts (S/S1) to part (N) using screws (#6).
 Note: Ensure parts (S/S1) are installed in the same orientation.
 B. Connect the other end of parts (S/S1) to part (E) using screws (#6)

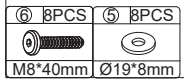
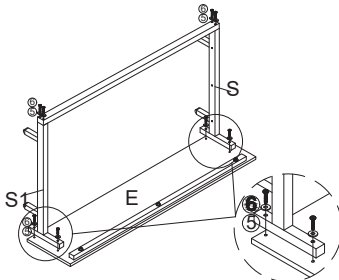

STEP 16

Assemble metal rods (I/J) into a single unit as shown in the diagram using screws (#6).

The hook-and-loop fastener of Part J is facing downward.
 The hole of Part J is facing upward, of Part I is facing downward.

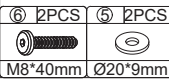
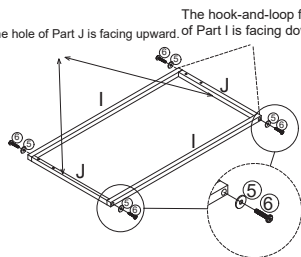

14

STEP 17

Attach parts (K/K1) to part (H) using screws (#1).

Note: Ensure the "ears" of parts (K/K1) face outward.

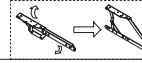
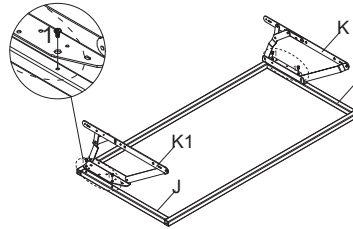

STEP 18

Attach parts (K/K1) to parts (S/S1) using screws (#1).

Note: Align the holes by tilting parts (K/K1) and (S/S1) for easier alignment.

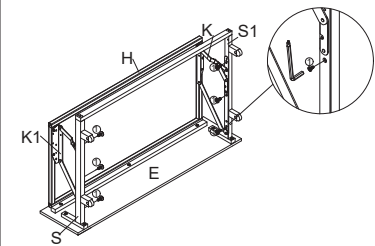

STEP 19

A. Fix the wheels (H) onto the side of the metal frame (N) using screws (#8).
 B. Install the slats (B) onto the frame.
 C. Secure part (F4-1) onto the frame panel as shown in the diagram.

Note: Ensure the Velcro side of the slats faces upward.

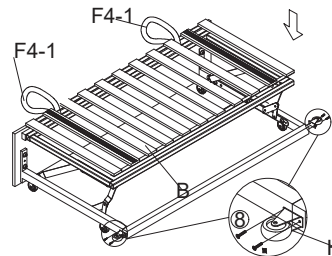

STEP 20

The support frame can be lifted and folded.

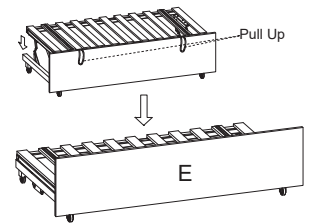

Pull the draw string to adjust the supporting frame.

15

STEP 21

Place the cushion (F1) onto the slats and secure it with Velcro.

Note: Remove the protective film from the Velcro on the cushion before attaching.

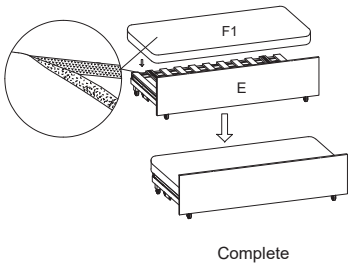

STEP 22

Push the pull-out bed frame into the sofa seat frame.

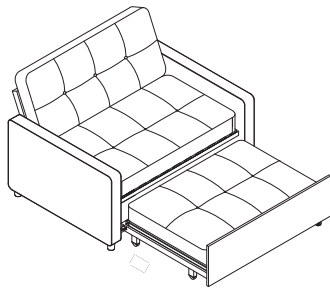

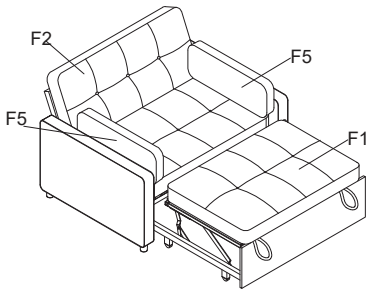

STEP 23

Place the armrest cushion (F5) onto the armrest of the sofa.



Maintenance/Wartung/mantenimiento/Entretien/Manutenzione

	<p>EN - Velvet Vacuum your piece monthly to keep the velvet looking like new. Use a nylon brush to remove any dirt or food. Contact a professional annually for a deep clean.</p> <p>DE - Samt Reinigen Sie den Samtbezug regelmäßig mit dem Staubsauger. Um größeren Schmutz zu entfernen, verwenden Sie bitte eine weiche Nylonbürste. Für eine Intensivreinigung empfehlen wir, einen professionellen Reinigungsdienst zu beauftragen.</p> <p>ES - Piel Aspire la pieza mensualmente para mantenerla como nueva. Utilice un cepillo de nylon para eliminar cualquier suciedad o comida. Póngase en contacto con un profesional anualmente para una limpieza profunda.</p> <p>FR - Velours Passez l'aspirateur sur le velours une fois par mois pour qu'il conserve l'aspect du neuf. Utilisez une brosse à textiles pour retirer la poussière ou les restes alimentaires. Faites effectuer une fois par an un nettoyage professionnel.</p> <p>IT - Velluto Passa l'aspirapolvere ogni mese per mantenere il velluto come nuovo. Usa una spazzola in nylon per rimuovere lo sporco. Rivolgiti alle agenzie di pulizia professionali per una pulizia profonda una volta l'anno.</p>
	<p>EN - Stubborn Stains Blot stains with a damp cloth and a dash of dish soap. Wipe away excess water with a clean towel. Let the material air-dry fully before use.</p> <p>DE - Hartnäckige Flecken Entfernen Sie Flecken vorsichtig mit einem feuchten Tuch und wenig Spülmittel. Überschüssiges Wasser zügig mit einem sauberen Handtuch abwischen. Und nach der Reinigung das Material gut trocknen lassen.</p> <p>ES - Manchas persistentes Remueva las manchas con un paño húmedo y una pizca de jabón para platos. Limpie el exceso de agua con una toalla limpia. Deje que el material se seque completamente al aire libre antes de utilizarlo.</p> <p>FR - Taches tenaces Tamponnez les taches avec un chiffon humide et un peu de liquide vaisselle. Essuyez l'excès d'eau avec un tissu propre. Laissez sécher complètement à l'air avant réutilisation.</p> <p>IT - Macchie resistenti Pulisci la macchia con un panno umido e un goccio di detersivo lavapiatti. Asciuga l'acqua in eccesso tramite un panno asciutto. Lascia che il materiale si asciughi completamente all'aria aperta prima dell'utilizzo.</p>

	<p>EN - Additional Tips Vacuum to remove any loose crumbs or dirt. Have a pet? Use a lint roller to gather up any fur.</p> <p>DE - Zusätzliche Tipps: Lose Krümel, Schmutz oder Staub durch einfaches staubsaugen entfernen. Haustierhaare können einfach mit Hilfe einer Fusselrolle entfernt werden.</p> <p>ES - Extra tips Aspire para eliminar las migas sueltas o la suciedad. Tiene mascota? utilice un rodillo para pelusas para remover los cabellos.</p> <p>FR - Autres conseils Retirez à l'aide d'un aspirateur les miettes et saletés. Si vous avez un animal, utilisez un rouleau anti-peluche pour ramasser les poils.</p> <p>IT - Suggestimenti Passa l'aspirapolvere per rimuovere ogni briciola rimasta o polvere. Hai animali domestici? Usa una spazzola adesiva per raccogliere tutti i peli.</p>
	<p>EN - Preventative Care Potate pillows and cushions monthly to ensure even wear. Avoid placing your piece in direct sunlight to prevent fading. Add a slipcover. Most are machine-washable and can change up your style!</p> <p>DE - Vorbeugende Pflege Durch regelmäßiges Wenden der Kissen und Polster können Sie eine vorzeitige Abnutzung vermeiden. Vermeiden Sie, ihr Möbelstück direkter Sonneneinstrahlung auszusetzen. Dies verhindert ein Ausbleichen des Stoffes. Ein passender Schutzbezug verhindert starke Verschmutzung, ist zudem meist maschinenwaschbar und auch geeignet um den Stil zu verändern!</p> <p>ES - Cuidados preventivos Rote las almohadas y los cojines mensualmente para asegurar un desgaste uniforme. Evite colocar sus piezas bajo la luz directa del sol para evitar el deterioro. Utilice una funda para cubrir. Las fundas pueden ser lavadas con máquina y pueden cambiar su estilo.</p> <p>FR - Soins préventifs Retournez les coussins une fois par mois pour une usure uniforme. N'exposez pas votre produit à la lumière directe du soleil afin d'éviter une décoloration. Ajoutez une housse: la plupart sont lavables en machine et vous permettent de changer de style.</p> <p>IT - Prevenzione Gira i cuscini mensilmente per evitare maggiore usura. Si prega di evitare di porre il prodotto sotto la luce del sole, in modo da evitarne lo sbiadimento. Aggiungi una fodera. La maggior parte delle fodere sono lavabili in lavatrici e possono migliorare il vostro stile.</p>