

Gebrauchsanweisung
Manuel du produit
Manual del producto
Manuale del prodotto

Thank you for choosing our products.

1. Return Policy







DO NOT RETURN TO THE STORE! Skip the process of returning your product and contact us directly for a replacement

If you find that parts of your order are missing or damaged, we will gladly ship any needed replacement parts free of charge.

If you have found any sort of defect, please contact our customer service department and let us know the details of your order and any issues encountered, we will try our best to provide you with a solution.

Recommendations Before Beginning Assembly

-  • Read instructions, cover to cover
-  • Have 2-4 adults on hand for assembly depending on product size
-  • Do not assemble directly on flooring or carpet
-  • Assemble on a clean non-marring surface (example: packing foam)
-  • Save all packaging until finished

3. Assembly Notice:

- If you encounter any problems during assembly and find that you cannot continue, rest assured we will help you solve the situation as soon as possible. Simply keep all of the parts of the product stored in a safe place and contact us immediately so we may assist you further.
- Once you have opened your package, remove all inner hardware packages and take the parts out. One by one, Place the parts out neatly in front of you, then refer to the instructions to ensure no parts are missing. If any pieces are found missing, please carefully look in the box first, as the hardware packaging might have torn making the hardware spill in the box.
- Some key parts of your product may be stored and hidden inside of other parts. Please open any zippered or hook & loop storage compartments to remove all parts. (example: cushions and legs being stored in the underside of a sofa)
 - **IMPORTANT:** When setting up your product, **DO NOT INSTALL THE SCREWS ALL THE WAY IN THE BEGINNING.** Place each screw into their proper hole and use your hand to twist the screw halfway. Twist all the screws in halfway to ensure the holes will match up properly and the product is level on the ground. When everything seems fitted, then tighten the screws.
 - When you have completed assembly, we suggest you have more than one person to assist you with lifting and placing the product.

Care & Maintenance

- 

 Do not put hot items directly on furniture surface
- 

 Do not clean furniture with harsh cleansers or polish
- 

 Do not place furniture under direct sunlight
- 

 Do not place furniture near heating or cooling vents
- 

 Do not write on furniture without a padded barrier to protect the surface
- 

 Do not place furniture outside. For indoor use only
- 

 Not for commercial use. For residential use only
- 

 Stains may be removed with mild soap solution and damp cloth
- 

 Children should not climb or jump on the furniture
- 







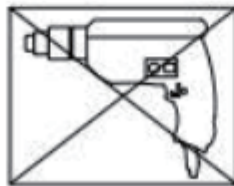

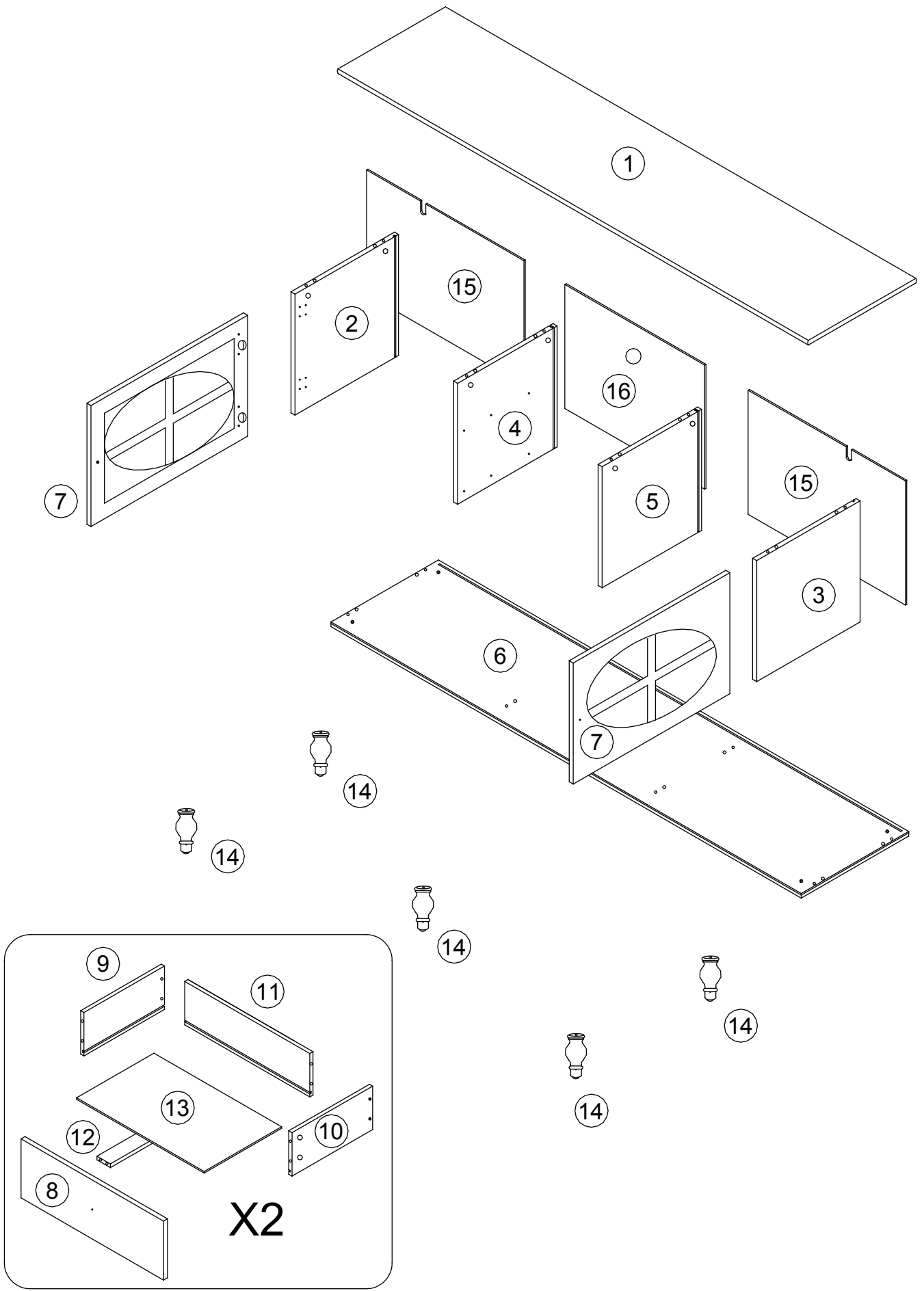

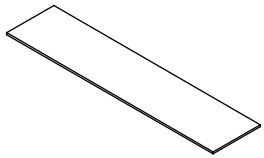



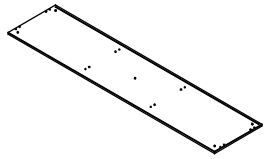



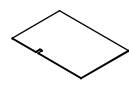
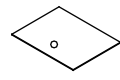
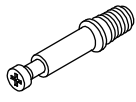
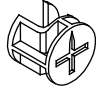
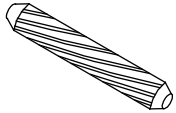
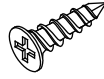
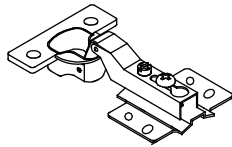
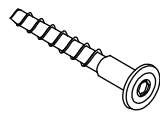
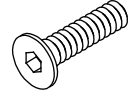
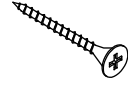
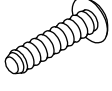

 Dust and pick-up spills using a clean, non-colored, lint-free cloth

Caution

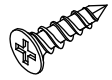
- This product contains small components. Please ensure that they are kept away from small children.
- Do not use power tools to assemble your furniture. Power tools may strip or damage the parts.

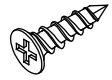
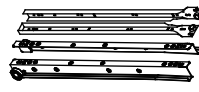
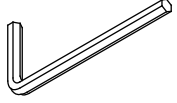
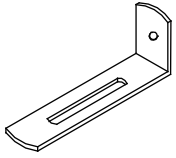

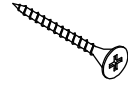
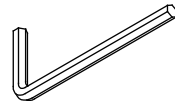

				
① x1PC	② x1PC	③ x1PC	④ x1PC	⑤ x1PC
				
⑥ x1PC	⑦ x2PCS	⑧ x2PCS	⑨ x2PCS	⑩ x2PCS
				
⑪ x2PCS	⑫ x2PCS	⑬ x2PCS	⑭ x5PCS	⑮ x2PCS
				
⑯ x1PC				
				
6*35mm	15*10mm	8*30mm	4*12mm	
Ax20PCS	Bx20PCS	Cx20PCS	Dx26PCS	Ex4PCS
				
7*40mm	8*35mm	4*30mm	4*16mm	
Fx8PCS	Gx5PCS	Hx8PCS	Ix4PCS	Jx4PCS
				
3*14mm		3*12mm		8mm
Kx12PCS	Lx12PCS	Mx20PCS	Nx2PCS	Ox1PC
				
Px2PCS	Qx2PCS	3.5*40mm	6mm	
		Rx2PCS	Sx1PC	Tx5PCS

STEP 1

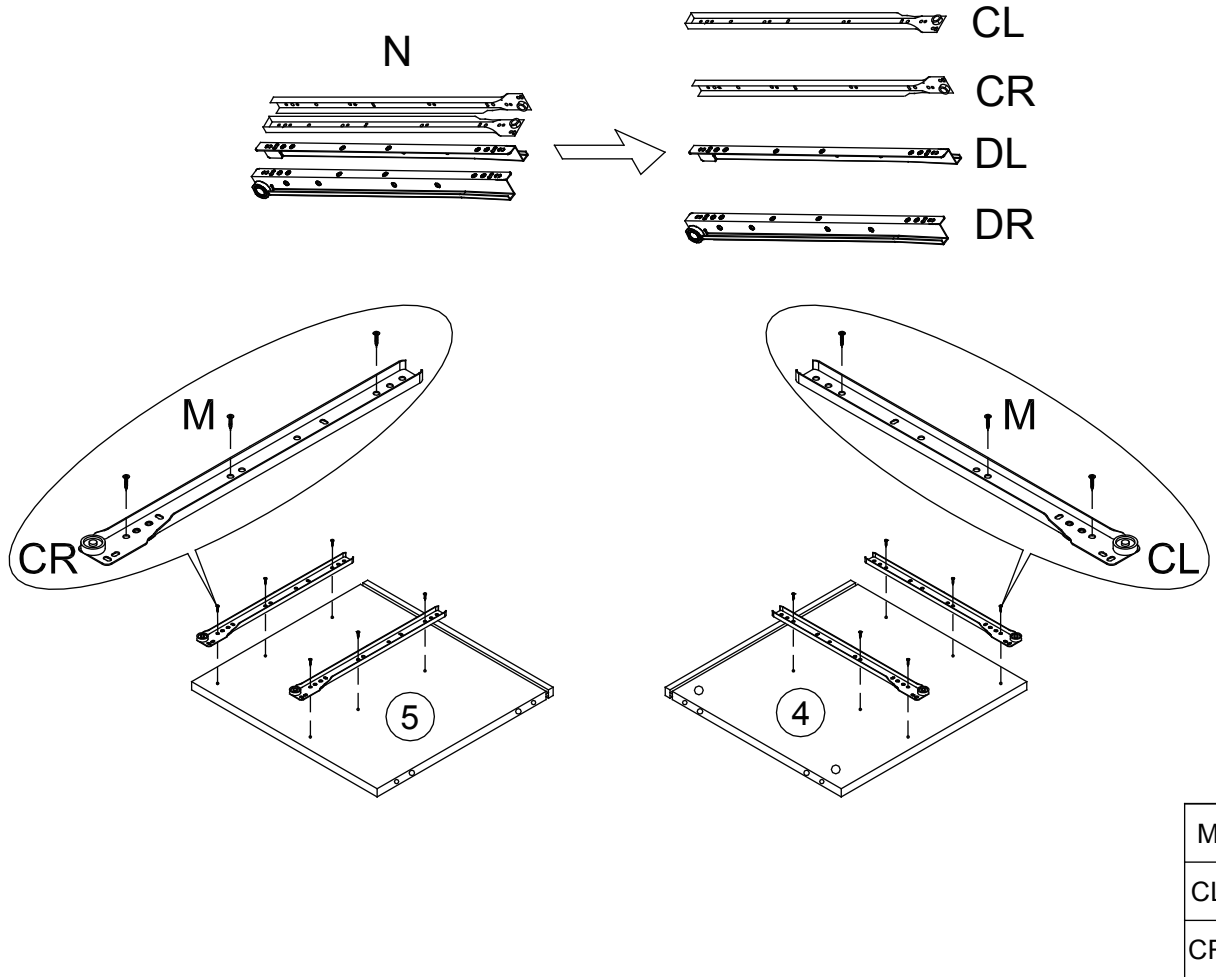

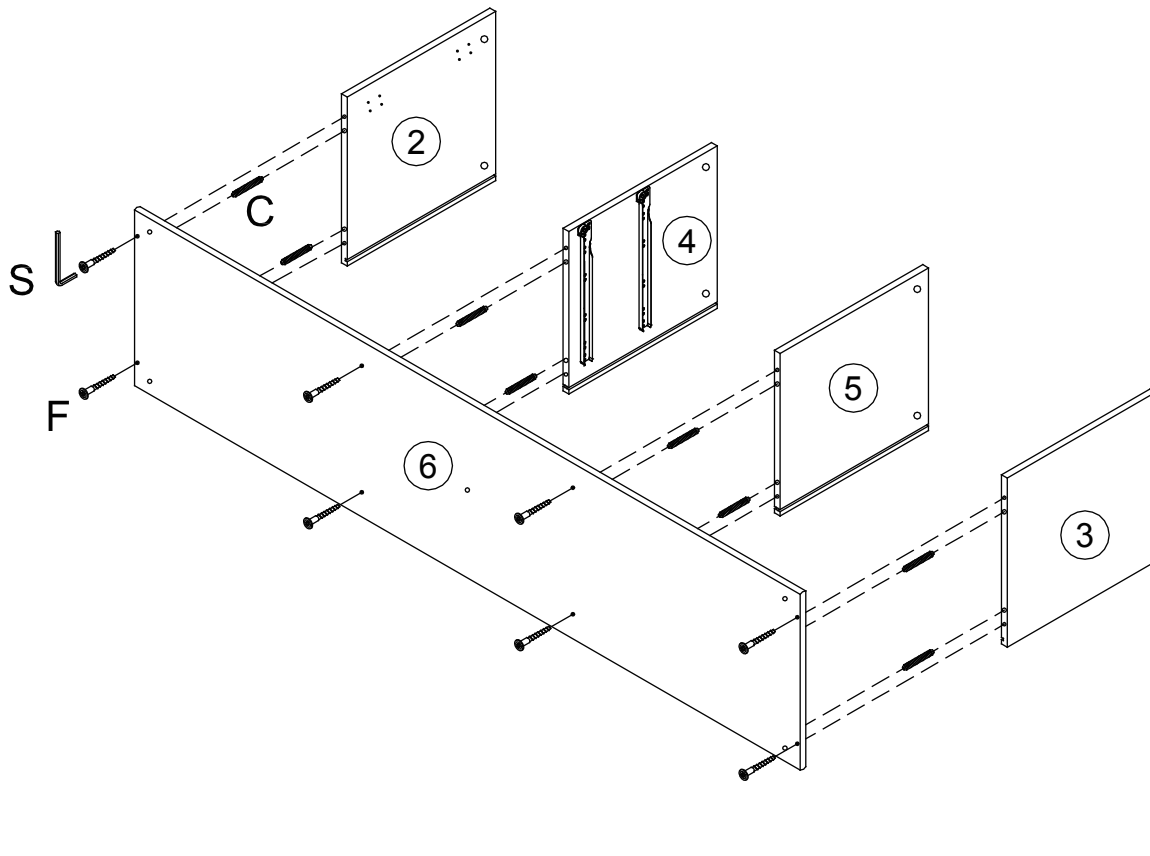

STEP 2



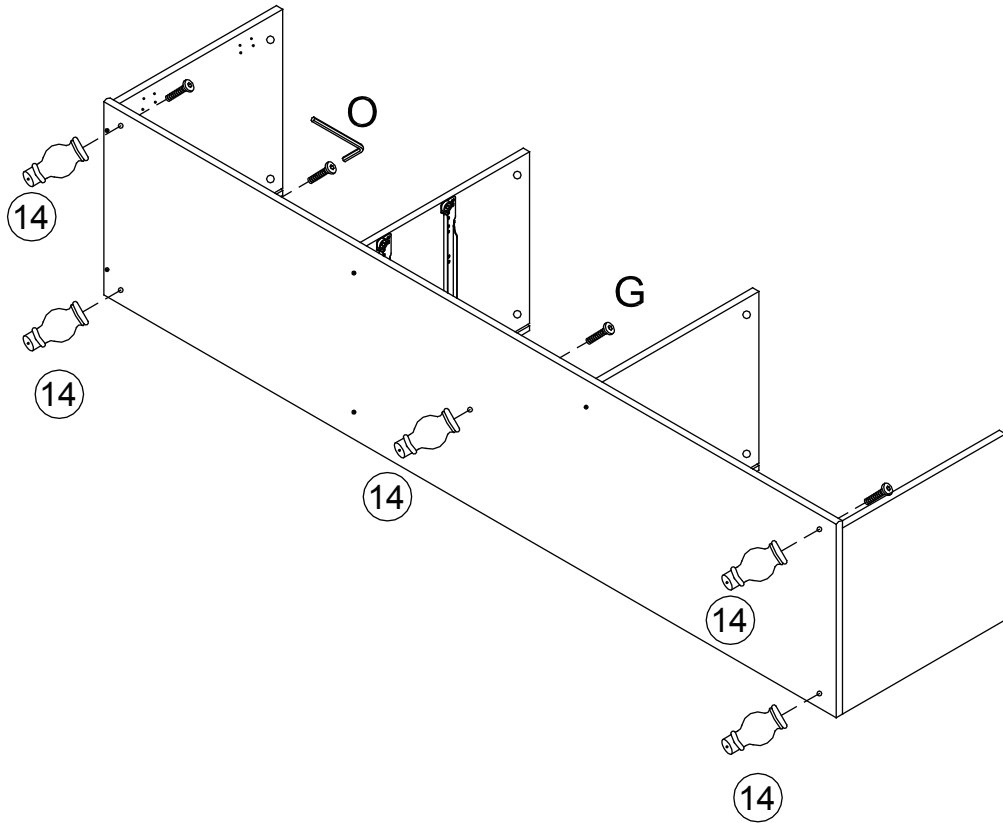

STEP 3

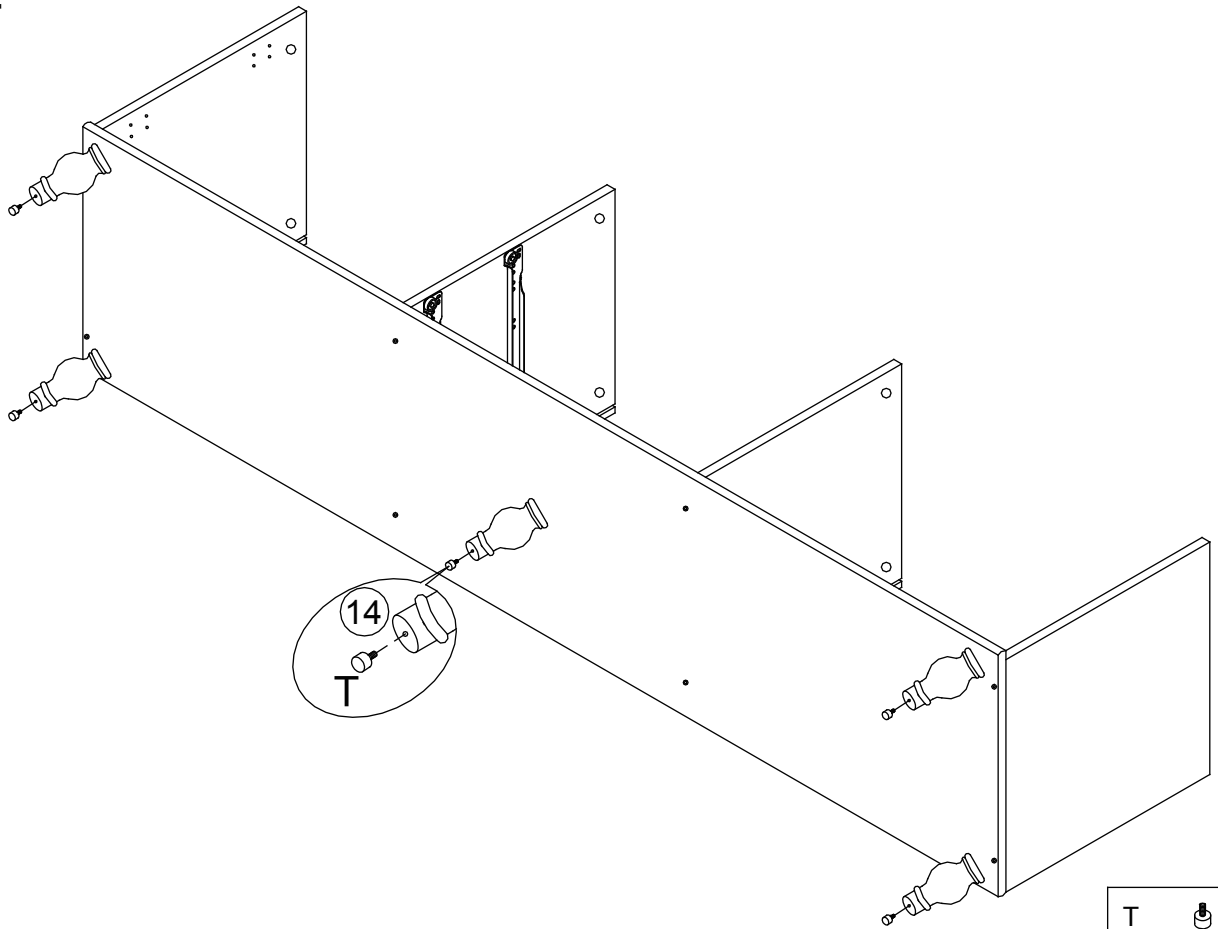

G		5 pcs
O		1 pc

STEP 4





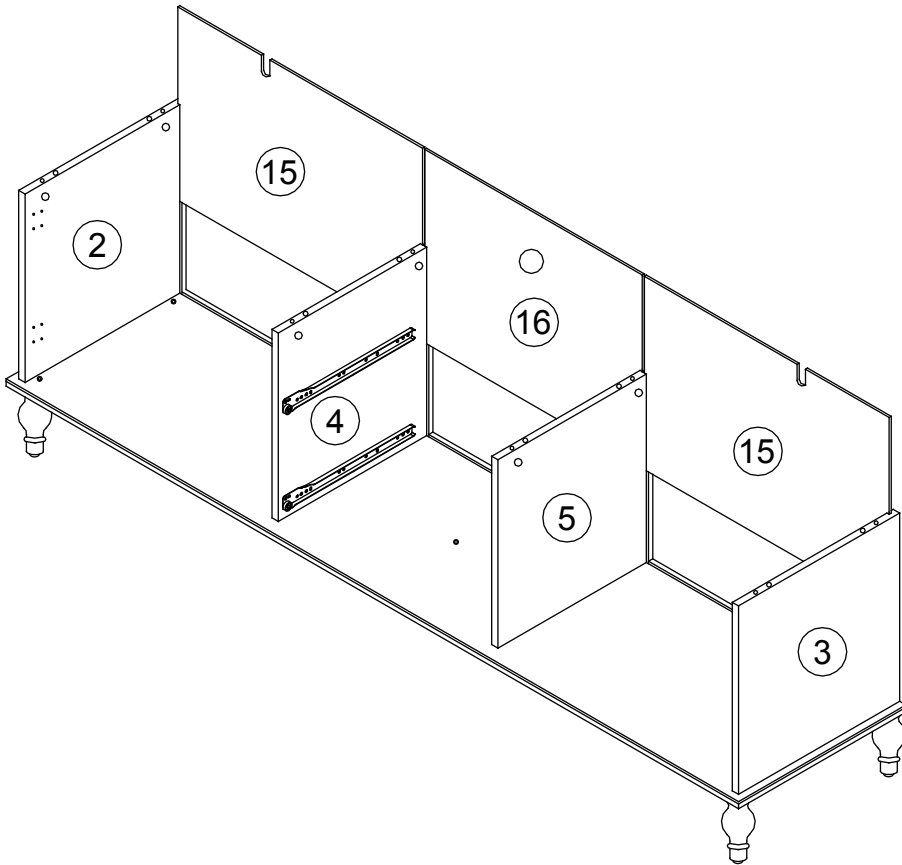

T		5 pcs
---	---	-------

STEP 5

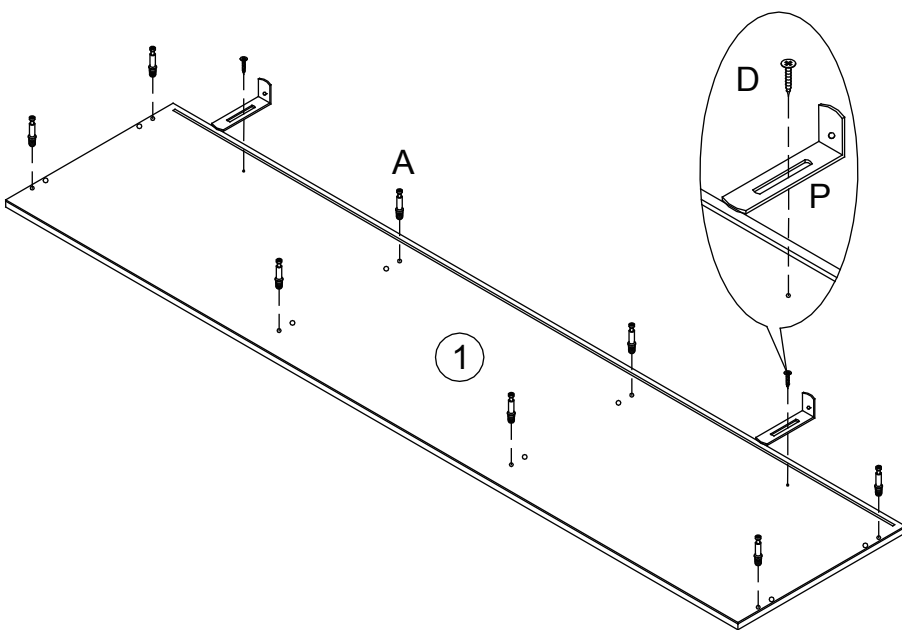



STEP 6



A		8 pcs
D		2 pcs
P		2 pcs

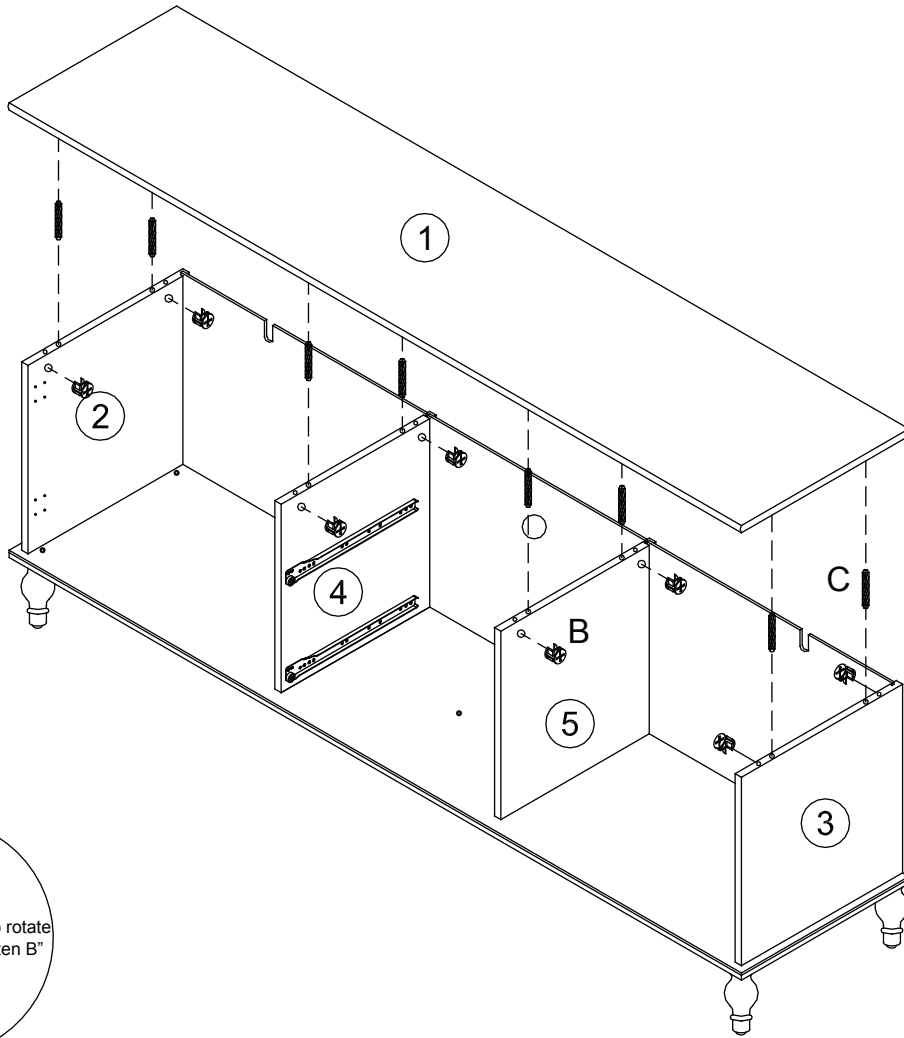

STEP 7



B		8 pcs
C		8 pcs

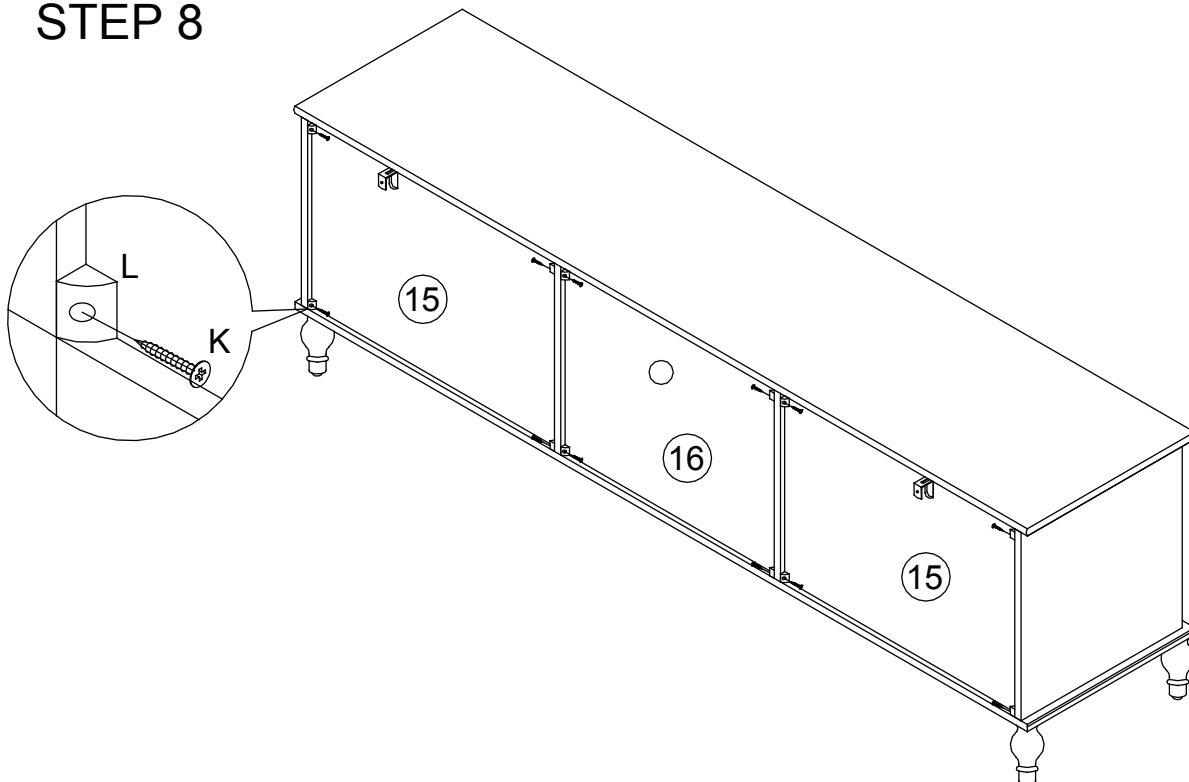

STEP 8



K		12 pcs
L		12 pcs

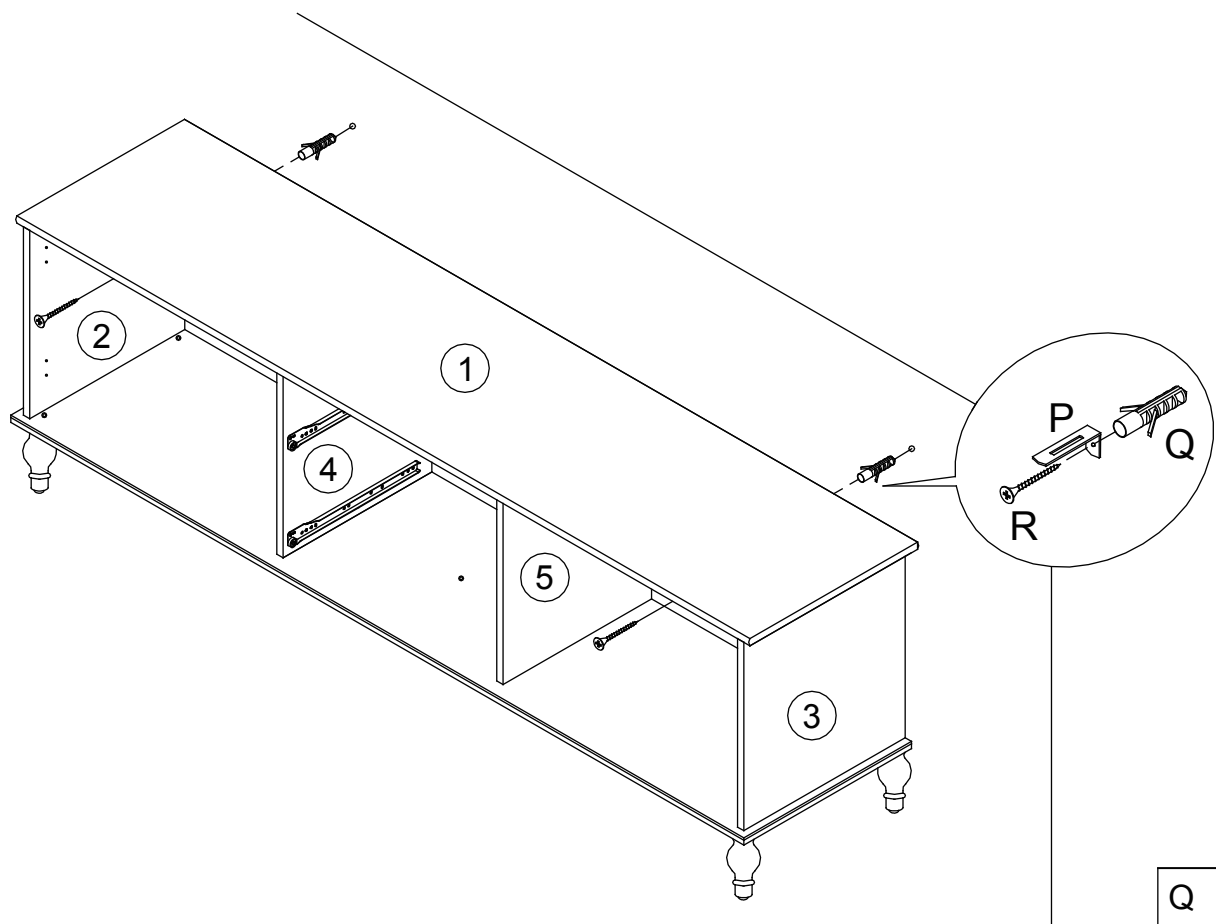

STEP 9



Q		2 pcs
R		2 pcs

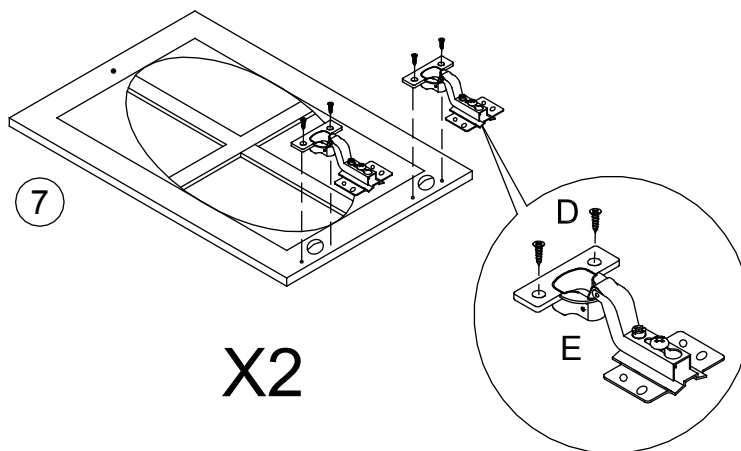

STEP 10

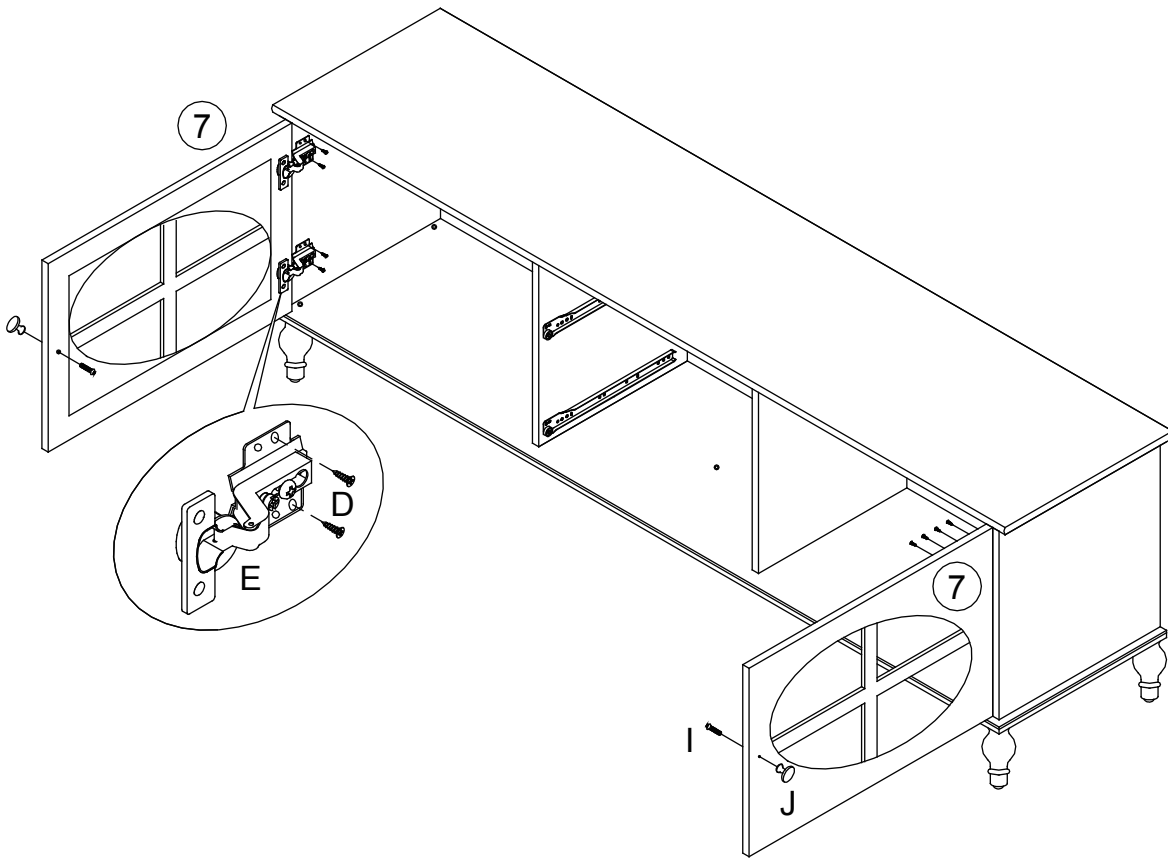

D		8 pcs
E		4 pcs

STEP 11



D		8 pcs
I		2 pcs
J		2 pcs

STEP 12

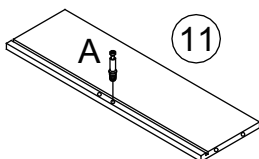
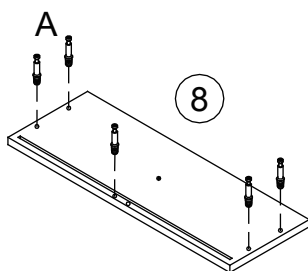



X2

A		12 pcs
---	---	--------

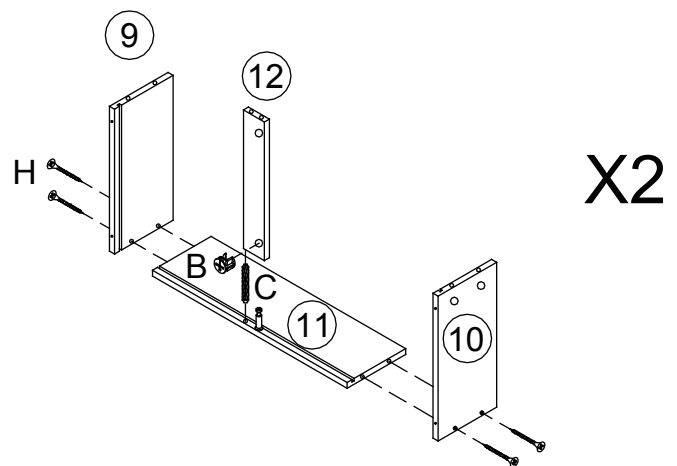
STEP 13



B		2 pcs
C		2 pcs
H		8 pcs

STEP 14

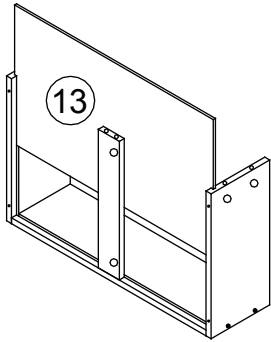

X2

STEP 15

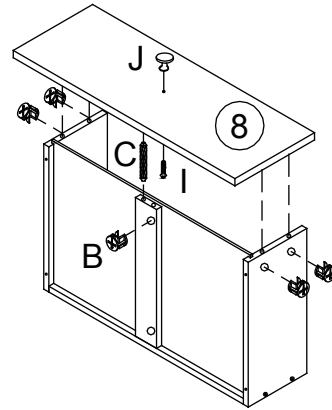

X2

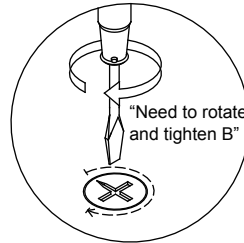

B		10 pcs
C		2 pcs
I		2 pcs
J		2 pcs

STEP 16

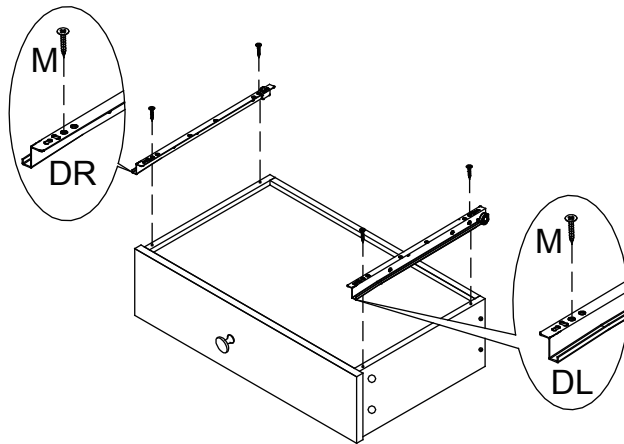
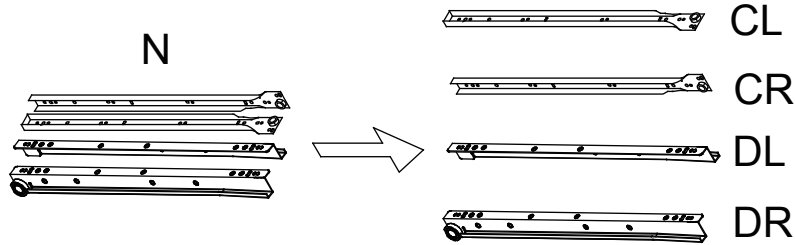

X2

M		8 pcs
DL		2 pcs
DR		2 pcs

STEP 17

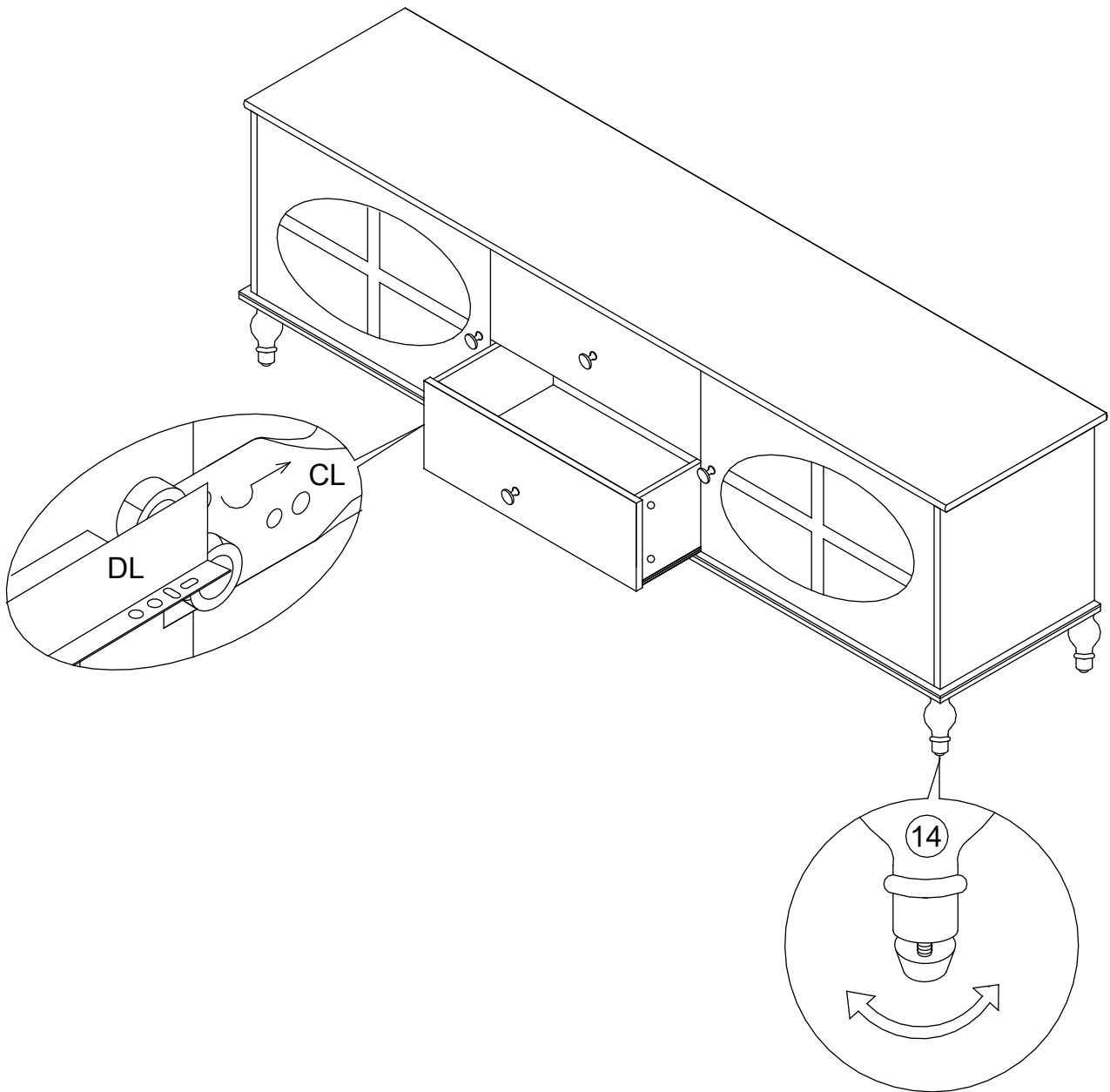

STEP 18

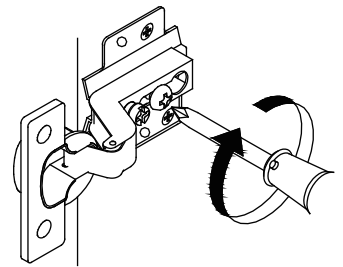
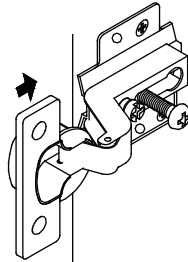
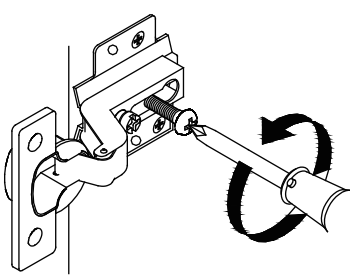
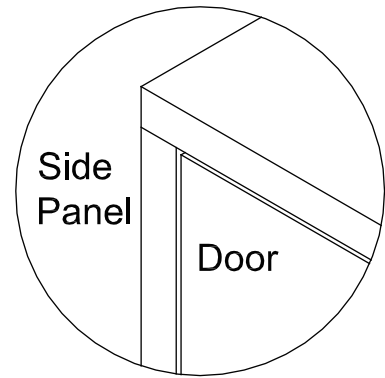
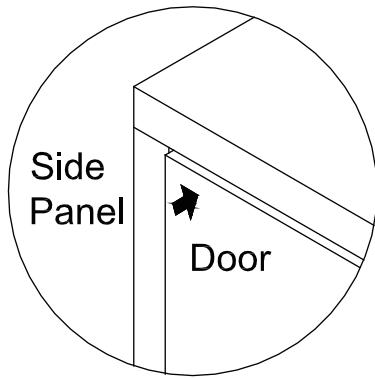

If the top of the door is not level with the side panel, loosen the screw at the back of the hinge as shown, then move the hinge in or out until the desired gap is achieved, and then re-tighten the back screw.

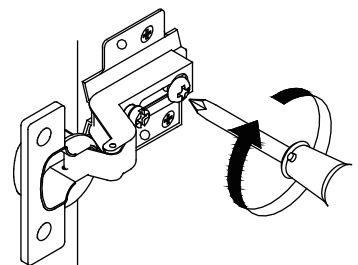
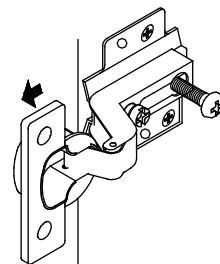
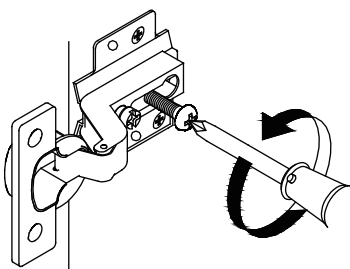
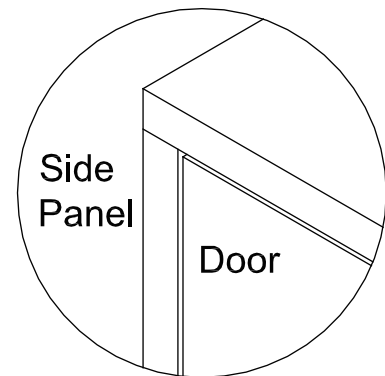
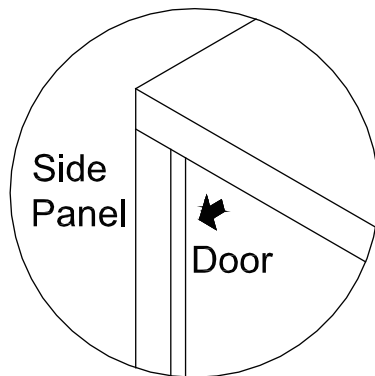

If the top of the door is not level with the side panel, loosen the screw at the back of the hinge as shown, then move the hinge in or out until the desired gap is achieved, and then re-tighten the back screw as shown.

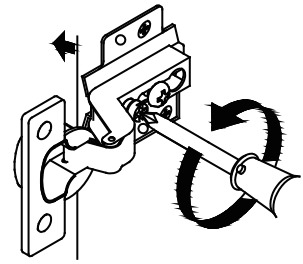
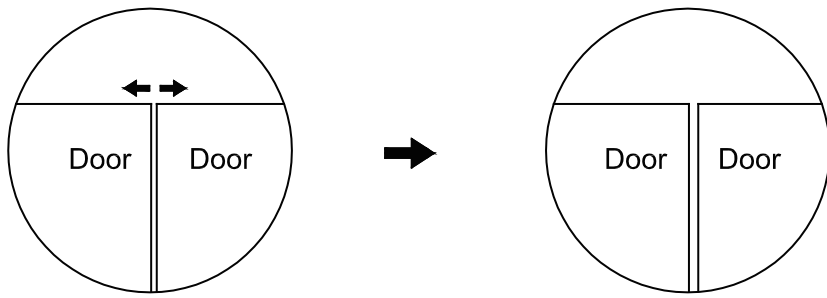

If the gap is too tight between the two doors, loosen the screw at the front of the hinge as shown to make the adjustment and then re-tighten the screw.

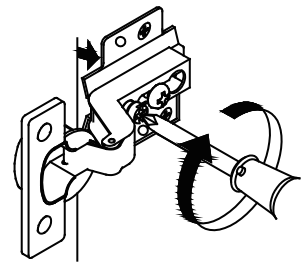
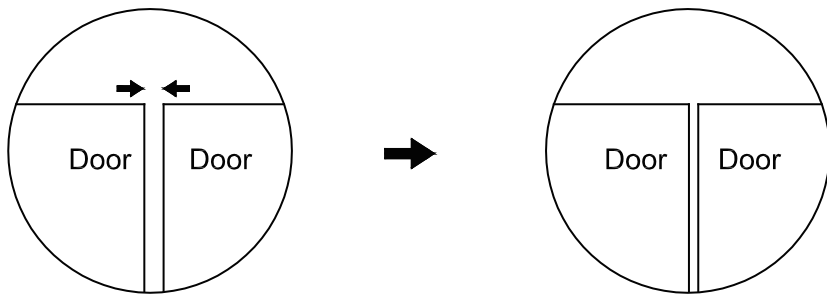

If the gap is too tight between the two doors, loosen the screw at the front of the hinge as shown to make the adjustment and then re-tighten the screw.

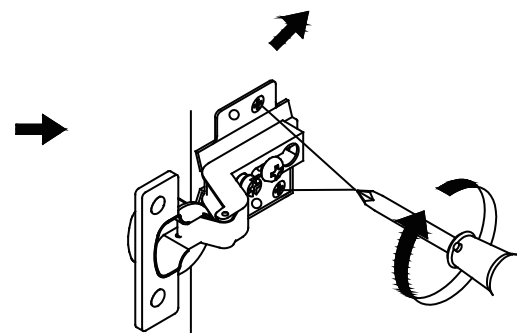
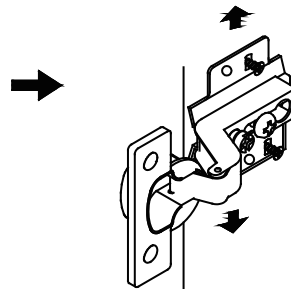
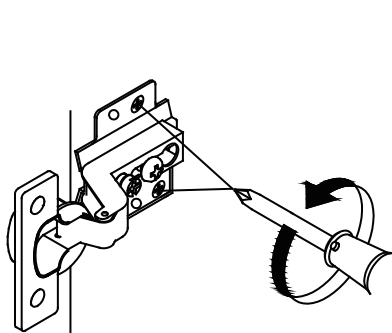
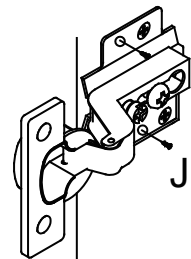
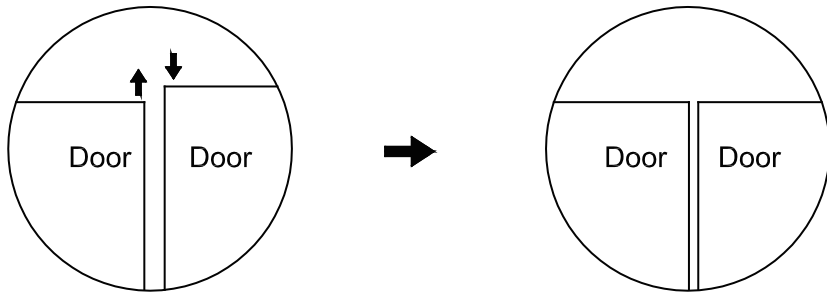

- If the doors are not leveled with each other, loosen the screws (installed on STEP 11) at the Panel Wing of the hinge, then adjust the hinge up or down until the desired level or when both doors are leveled, and then re-tighten the screws.
- When all the desired positions are in place, use the remaining eight Screw (D) to fasten the Wing Panel using the front two screw holes on Panel Wing. Please note the holes are not pre-drilled, please screw carefully and do not hurt the hand.

The assembly of the Cabinet is complete.

D  8 pcs