

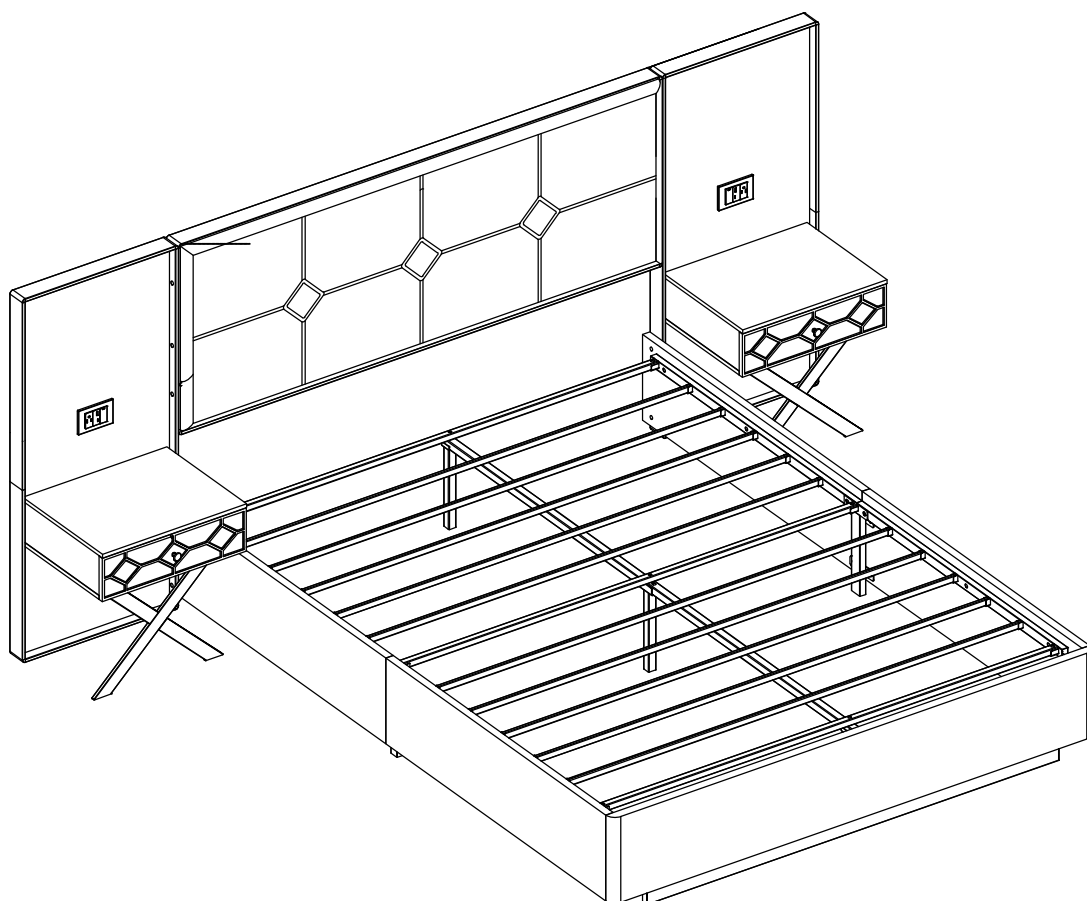















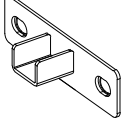

ASSEMBLY INSTRUCTIONS

Compression must wait for 72 hours before it can be unfolded, and it needs to be flapped by hand

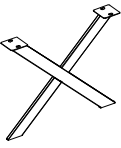
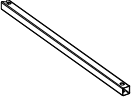
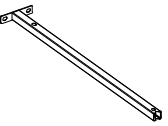

parts list

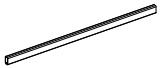
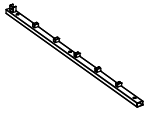
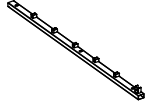
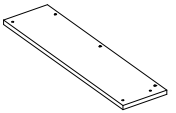
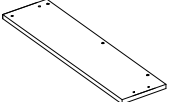
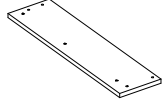
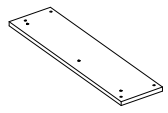
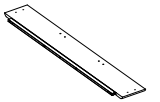
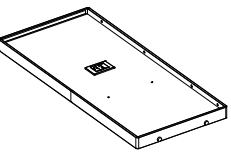
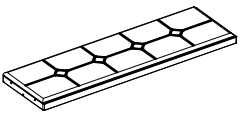
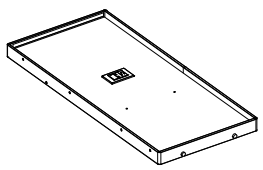
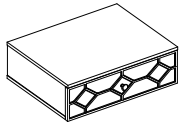
1  M6*30 4pcs	2  M8*55 3pcs	3  M8*40 12pcs	4  M8*30 8pcs	5  M8*15 10pcs	6  M8*20 26pcs	7  M8*16 6pcs	9  M6*19 4pcs	10  M8 2pcs	11  M6 1pcs
12  M8*30 4pcs	B  2pcs	B1  2pcs	B2  2pcs	B3  2pcs	B4  1pcs				
B5  2pcs	C1  1pcs	C2  1pcs	C3  3pcs						
C4  10pcs	C5  2pcs	C6  2pcs	D1  1pcs						
D2  1pcs	D3  1pcs	D4  1pcs	D5  1pcs						
E1  1pcs	E2  1pcs	E3  1pcs	E4  2pcs						

packing list







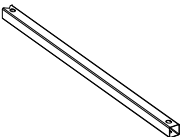
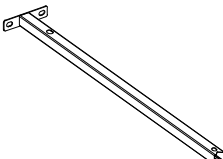
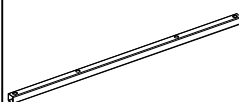
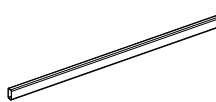
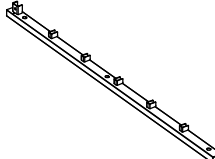
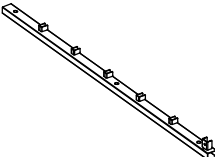
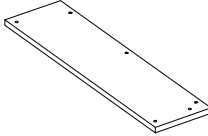
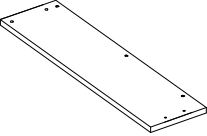
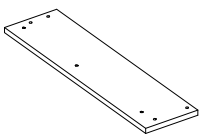
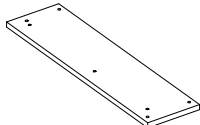
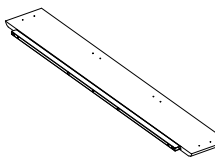
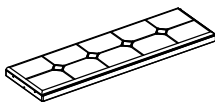







Q bed: 1x5 2x4 3x13 4x9 5x11 6x28 7x7 9x4 10x2 11x1 12x5
 Bx2 B1x2 B2x2 B3x4 B4x2 B5x2
 C1x2 C2x2 C3x3 C4x10 C5x2 C6x2
 D1x1 D2x1 D3x1 D4x1 D5x1
 E1x1 E2x1 E3x1 E4x2 (Including spare hardware)

Note: The package is as follows.

A box

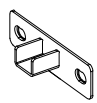
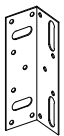
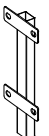
<p>C1</p>  <p>1pcs</p>	<p>C2</p>  <p>1pcs</p>	<p>C3</p>  <p>3pcs</p>	<p>C4</p>  <p>10pcs</p>	<p>C5</p>  <p>2pcs</p>	<p>C6</p>  <p>2pcs</p>
<p>D1</p>  <p>1pcs</p>	<p>D2</p>  <p>1pcs</p>	<p>D3</p>  <p>1pcs</p>	<p>D4</p>  <p>1pcs</p>	<p>D5</p>  <p>1pcs</p>	<p>E2</p>  <p>1pcs</p>

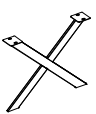
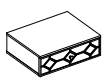
B box

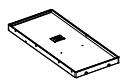
<p>1</p>  <p>M6*30 4pcs</p>	<p>2</p>  <p>M8*55 3pcs</p>	<p>3</p>  <p>M8*40 12pcs</p>	<p>4</p>  <p>M8*30 8pcs</p>	<p>5</p>  <p>M8*23 10pcs</p>	<p>6</p>  <p>M8*20 26pcs</p>	<p>7</p>  <p>M8*16 6pcs</p>
<p>9</p>  <p>M6*19 4pcs</p>	<p>10</p>  <p>M8 2pcs</p>	<p>11</p>  <p>M6 1pcs</p>	<p>12</p>  <p>M8*30 4pcs</p>	<p>B</p>  <p>2pcs</p>	<p>B1</p>  <p>2pcs</p>	<p>B2</p>  <p>2pcs</p>
<p>B3</p>  <p>2pcs</p>	<p>B4</p>  <p>1pcs</p>	<p>B5</p>  <p>2pcs</p>	<p>E4</p>  <p>2pcs</p>	<p>E1</p>  <p>1pcs</p>	<p>E3</p>  <p>1pcs</p>	

Installation method

Step 1

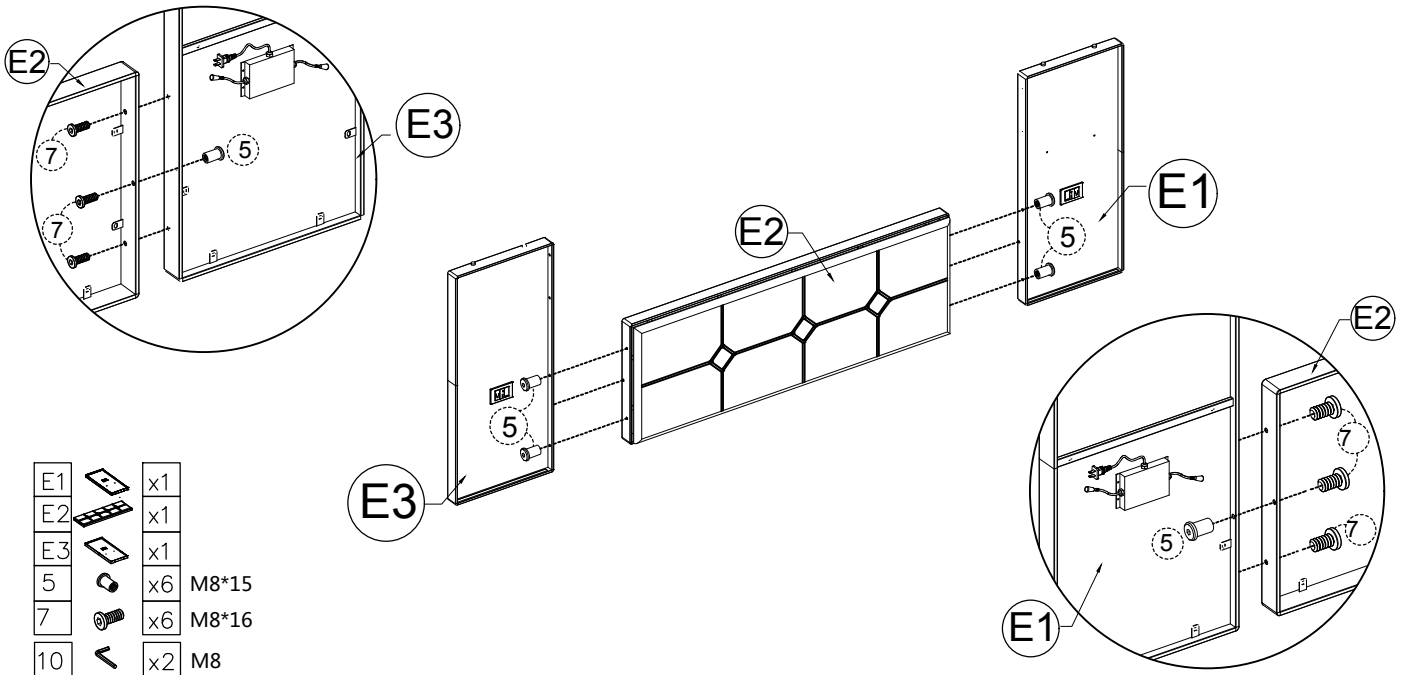

Step 2

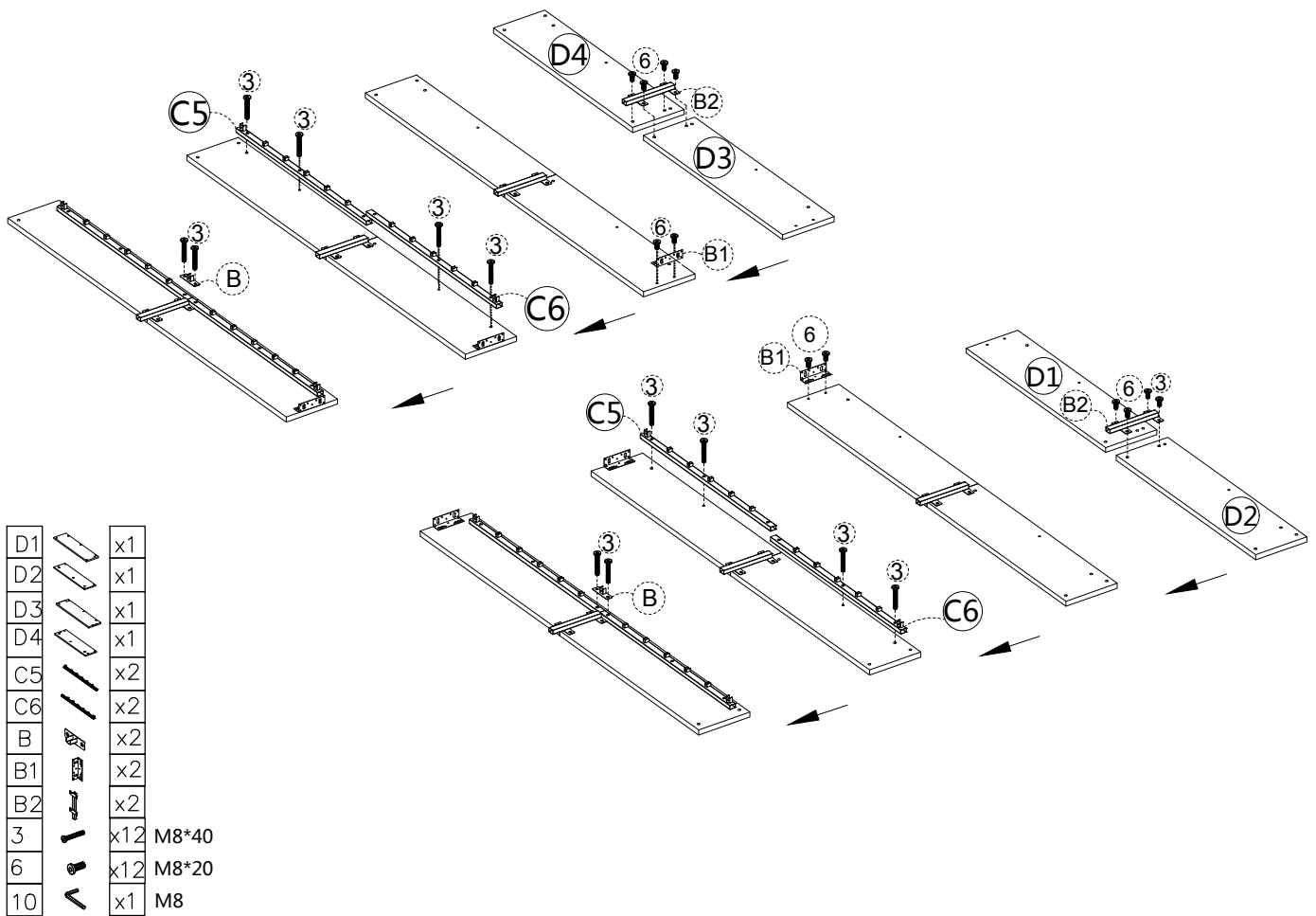

Installation method

Step 3

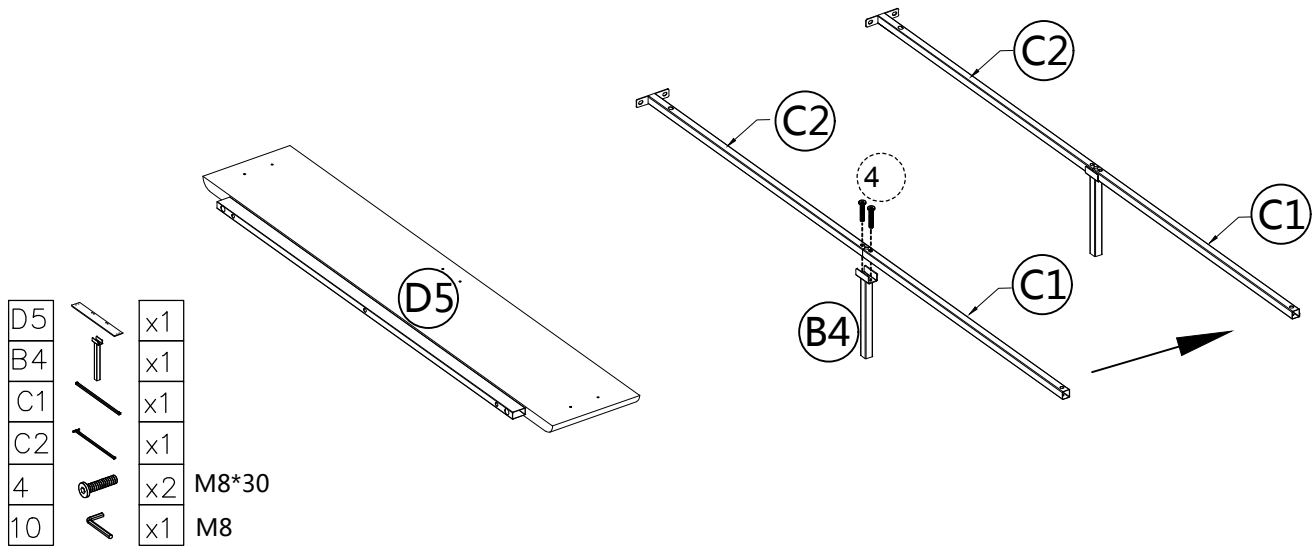



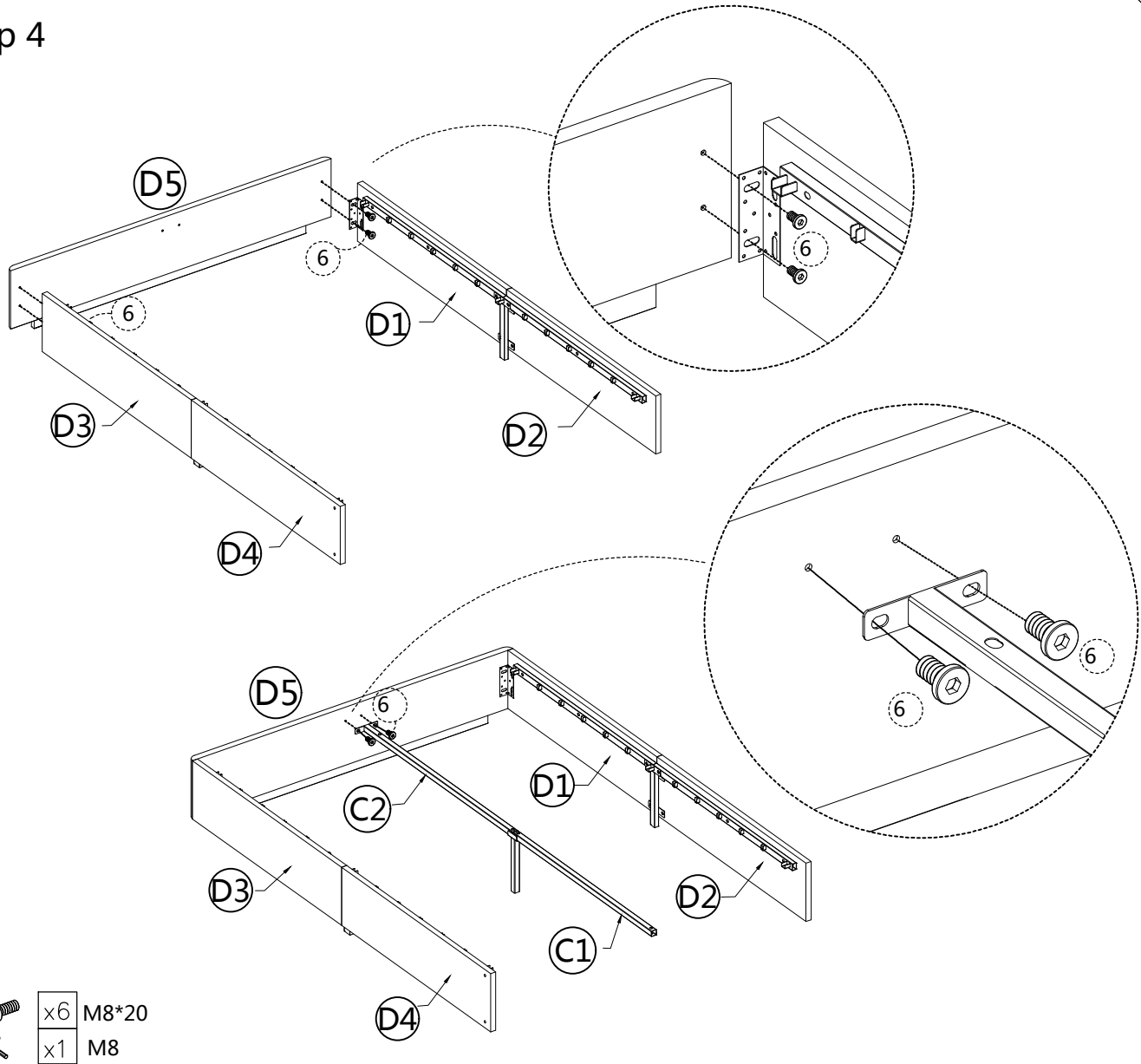



Step 4

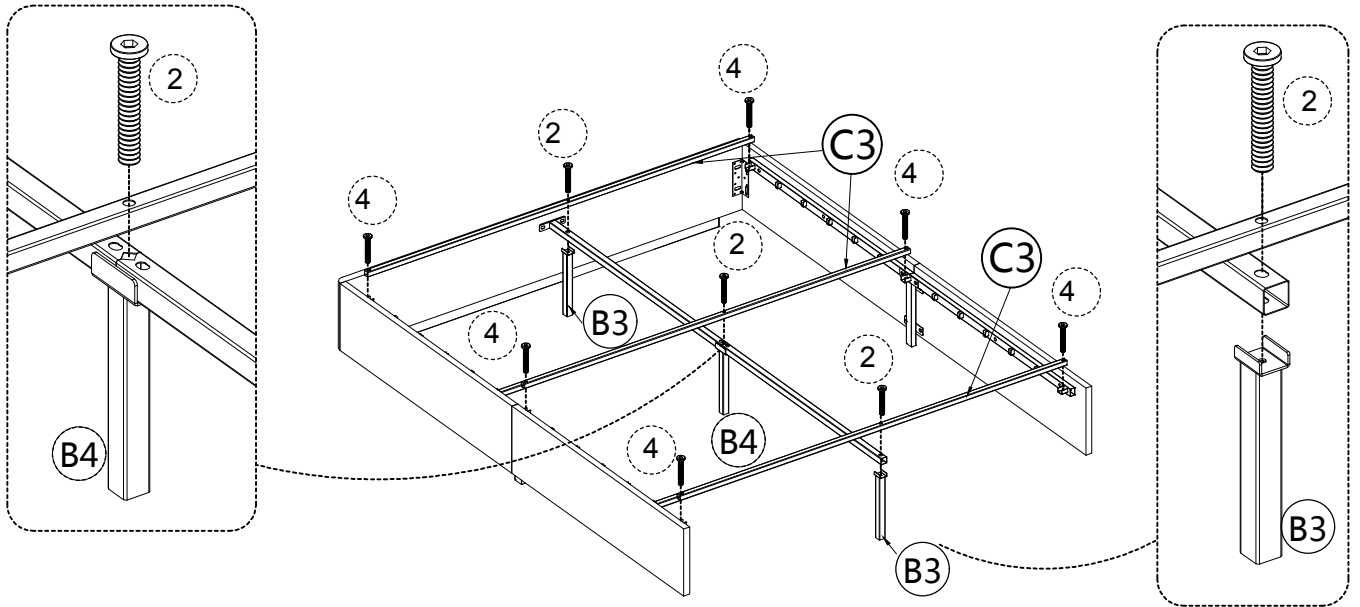

Installation method



Step 5

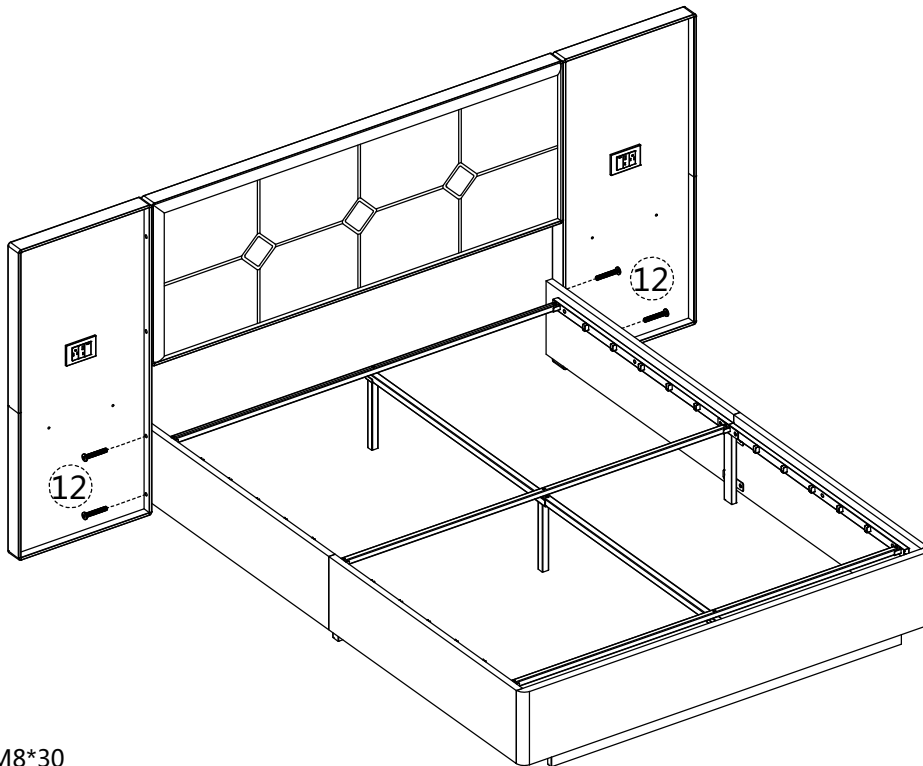

B3		x2	
C3		x3	
2		x3	M8*55
4		x6	M8*30
10		x1	M8

Step 6



12		x4	M8*30
5		x4	M8*23
10		x1	M8

Installation method

Step 7

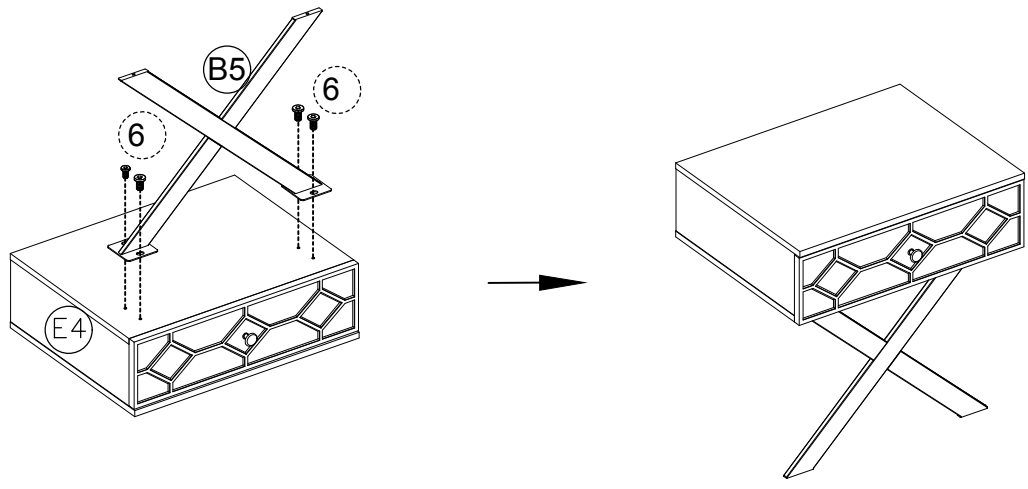

E4		x2	
B5		x2	
6		x8	M8*20
10		x1	M8

Step 8

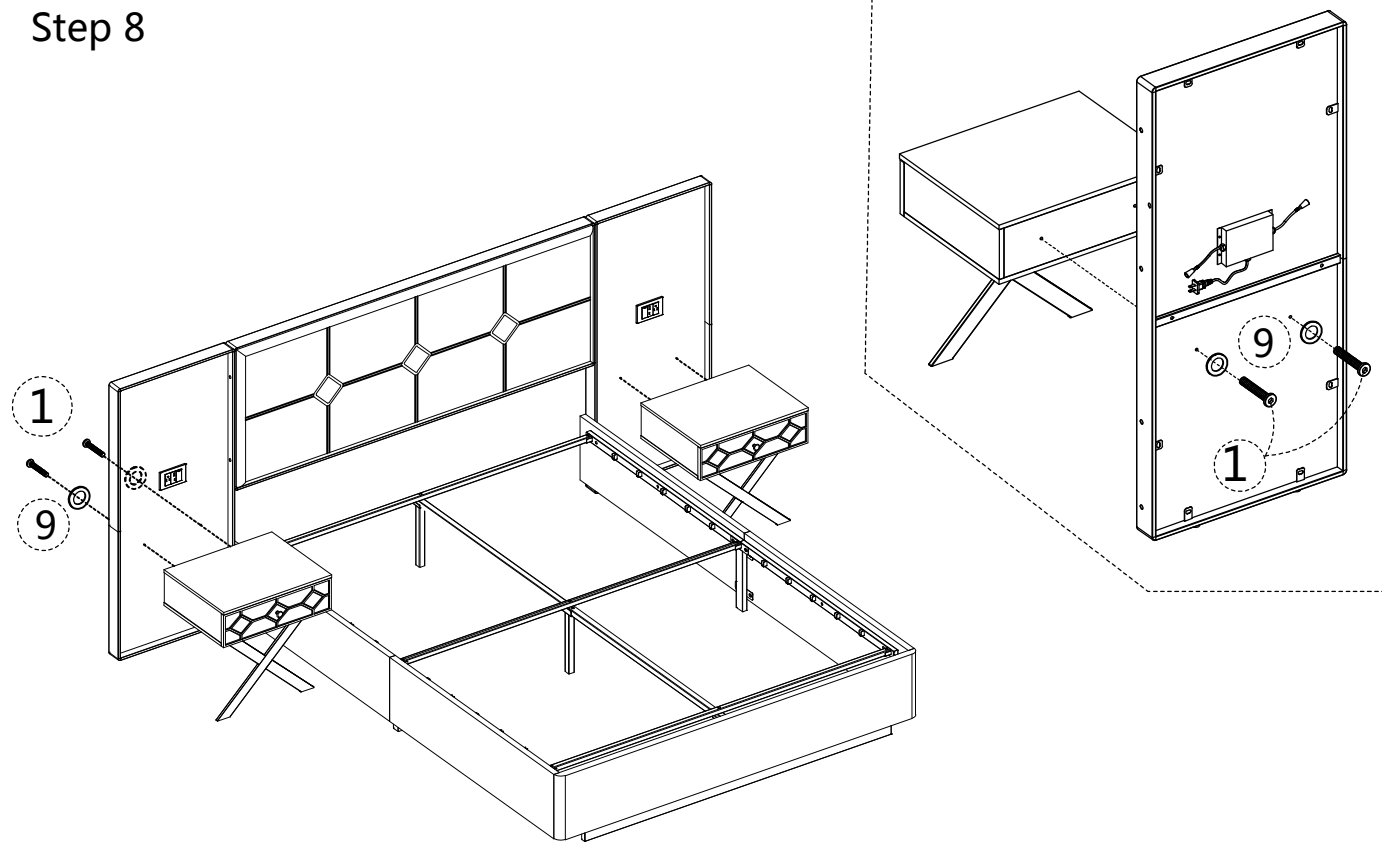

A		x4	M6*35
9		x4	M6*19
11		x1	M6

Step 9

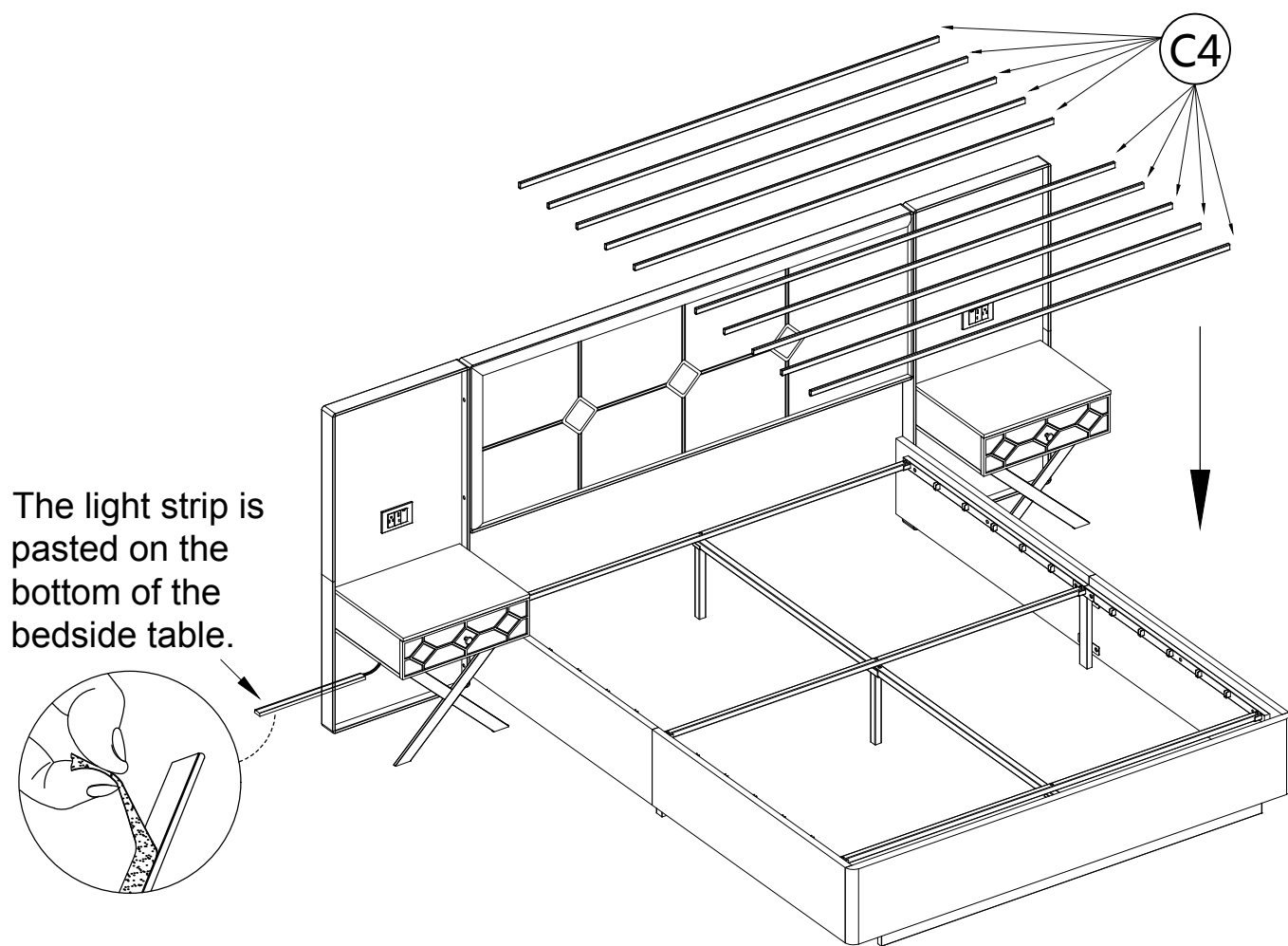

The light strip is pasted on the bottom of the bedside table.

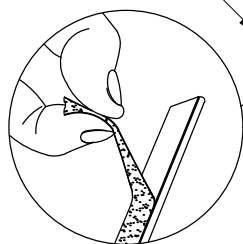

C4 — x10

Assembly completed!

Please enjoy the bed