

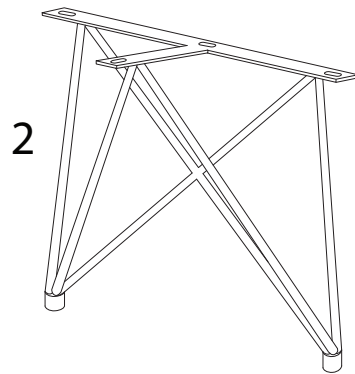

	<p>10'</p>
		
		<p>2</p>

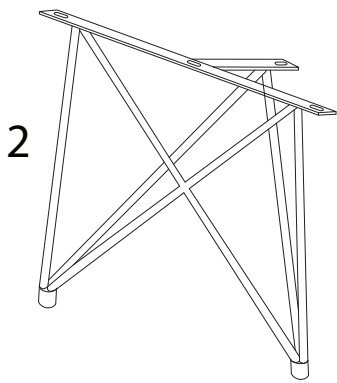
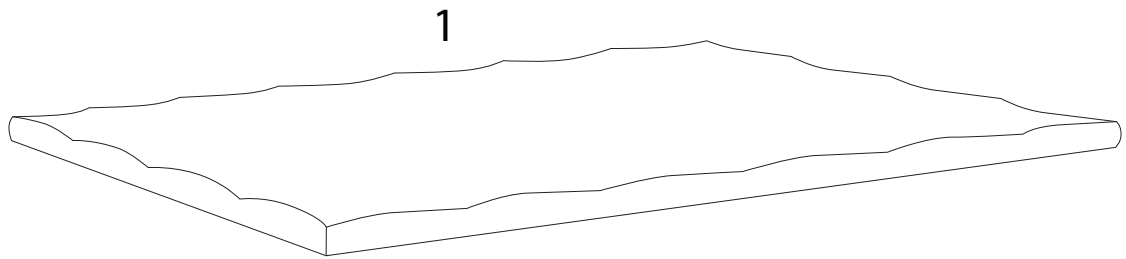

1	2	A	B	C	D
					
x 1	x 2	x 8	x 8	M5 x 23 x 8	x 1

1

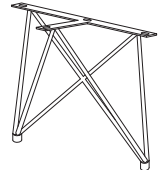
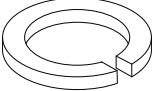
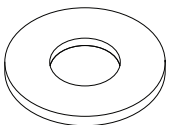
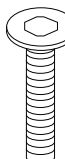
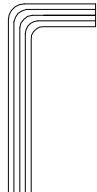
<p>1</p>  <p>x 1</p>	<p>2</p>  <p>x 2</p>	<p>A</p>  <p>x 8</p>	<p>B</p>  <p>x 8</p>	<p>C</p>  <p>M5 x 23</p> <p>x 8</p>	<p>D</p>  <p>x 1</p>
---	---	---	--	--	---

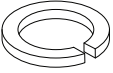
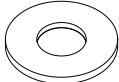
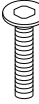
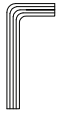