

Pure & Easy

ASSEMBLY INSTRUCTIONS

NOTICE

IMPORTANT, RETAIN FOR FUTURE REFERENCE: READ CAREFULLY
WICHTIG, FÜR SPÄTERE NACHSCHLAGE AUFBEWAHREN: SORGFÄLTIG LESEN
IMPORTANTE, GUARDAR PARA REFERENCIA FUTURA: LEER ATENTAMENTE
IMPORTANTE, CONSERVARE PER RIFERIMENTI FUTURI: LEGGERE ATTENTAMENTE
IMPORTANT, À CONSERVER POUR RÉFÉRENCE FUTURE : LIRE ATTENTIVEMENT

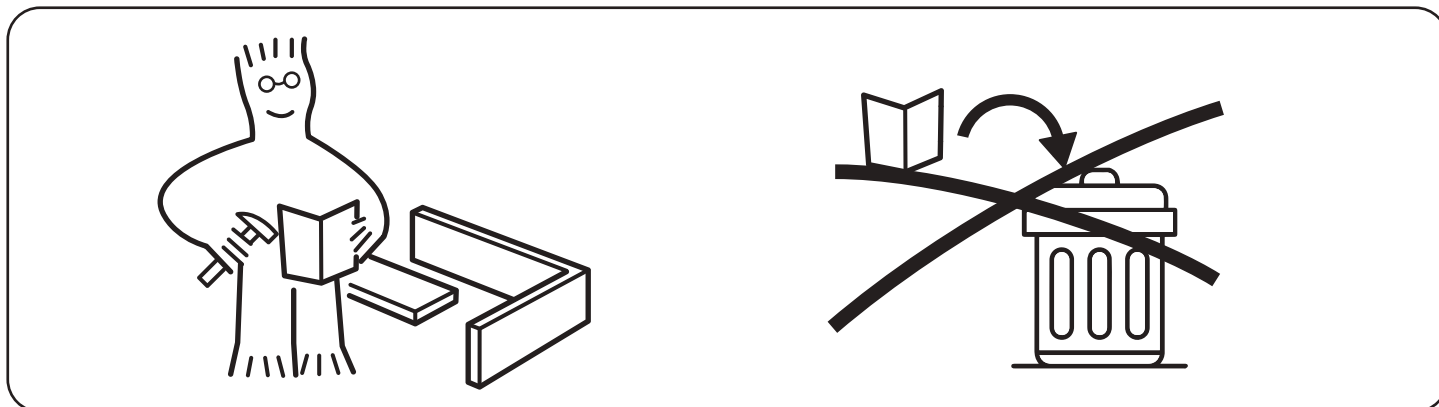

Assemble on a flat, clean and soft surface.
Auf einer flachen, sauberen und weichen Oberfläche zusammenbauen.
Assembler sur une surface plate, propre et douce.
Assemblare su una superficie piatta, pulita e morbida.
Ensamblar sobre una superficie plana, limpia y suave.

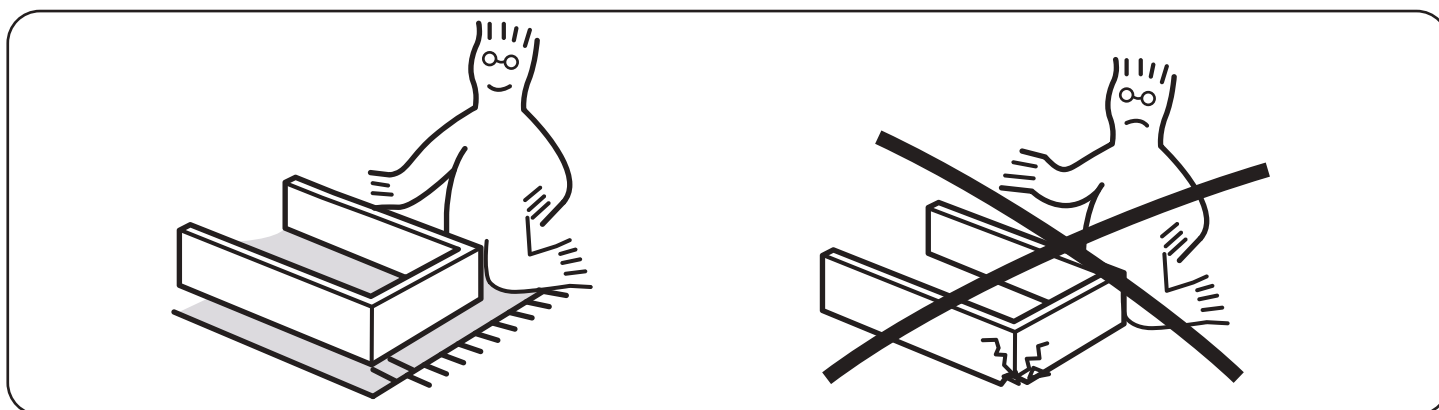

Professional installation is highly recommended.
Eine professionelle Installation wird dringend empfohlen.
Une installation professionnelle est fortement recommandée.
Si raccomanda vivamente l'installazione professionale.
Se recomienda altamente la instalación profesional.



Periodically Check That All Components Are Tightly Secured.
Überprüfen Sie Regelmäßig, Dass Alle Komponenten Fest Gesichert Sind.
Vérifiez Périodiquement Que Tous Les Composants Sont Bien Fixés.
Controllare Periodicamente Che Tutti I Componenti Siano Ben Fissati.
Verifique Periódicamente Que Todos Los Componentes Estén Bien Asegurados.

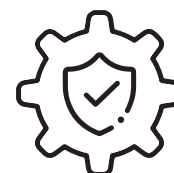

It is recommended that multiple people assemble this product.
Es wird empfohlen, dass mehrere Personen dieses Produkt zusammenbauen.
Il est recommandé que plusieurs personnes assemblent ce produit.
Si raccomanda che più persone assemblino questo prodotto.
Se recomienda que varias personas ensamblen este producto.

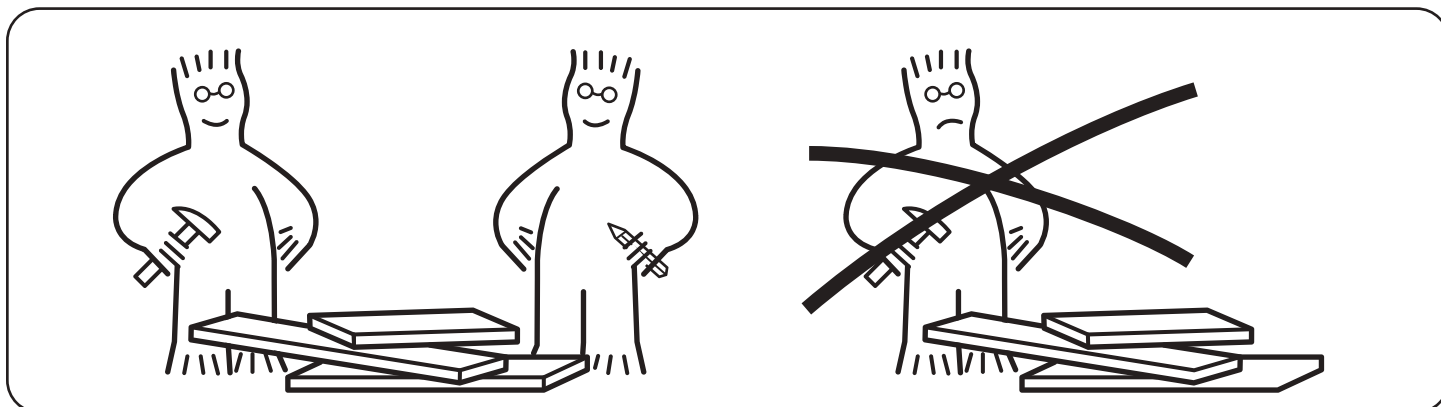

Please have the following auxiliary tools ready:

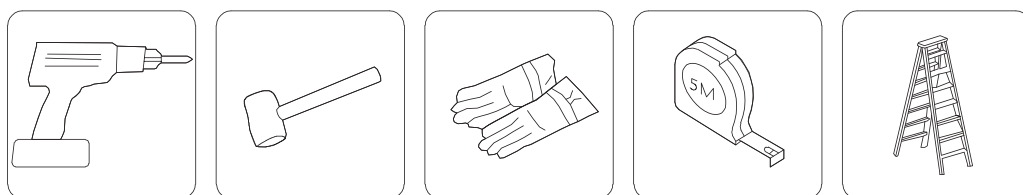



WARNING

Important Before Use:

Damage from improper installation or adverse weather use is the user's sole responsibility.

Do not use this tent in high winds, heavy snow, or inclement weather.



Do not insert L-shaped stakes vertically. For enhanced stability, drive stakes into the ground at a 45° angle.



This tent is designed as a temporary structure. Do not leave unattended outdoors for extended periods or overnight.



When the wind speed is high, ensure all doors are open and aligned with the wind direction to prevent the tent from being lifted or blown away.

Setup and Use Instructions:

1. Store tent in a climate-controlled area. Clear debris before setup/takedown; Avoid contact between fabric and sharp/hard objects.
2. Setup on flat ground, $\geq 1.8\text{m}$ away from obstacles. Secure with stakes and guy ropes to prevent collapse and hazards.
3. Ground nails for grass; expansion screws for hard surfaces (e.g. concrete). Do not mix.
4. Assemble poles per manufacturer's instructions; ensure tight connections—do not force assembly.
5. Inspect before use: confirm all fasteners are tightened; check for loose parts, uneven tension or safety risks.
6. Keep open flames/heat sources away—tent is not fire-resistant.
7. Implement regular maintenance; inspect stakes, ropes and structure for stability and safety.

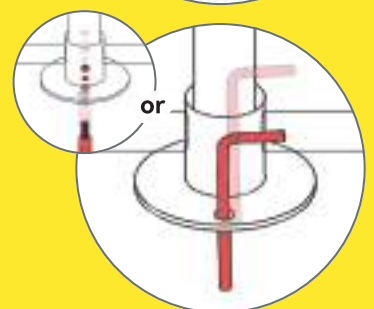
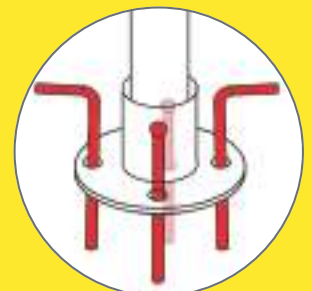



The following installation methods will provide better wind resistance performance, extend the product's lifespan, and help you maximize its value, delivering an even better user experience.

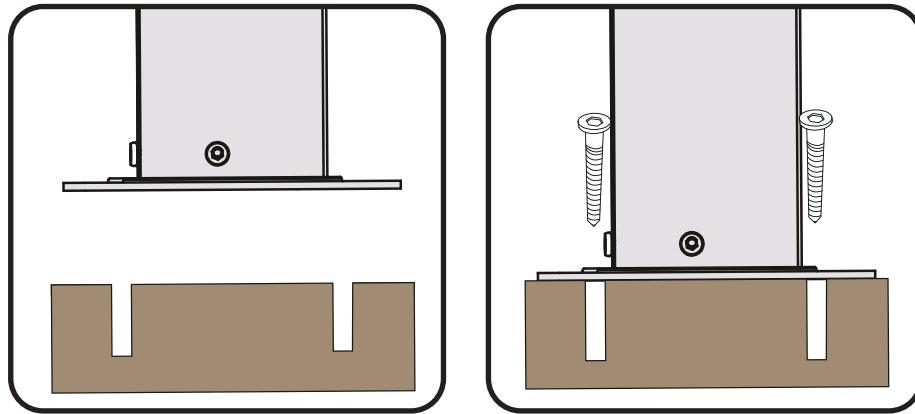

1



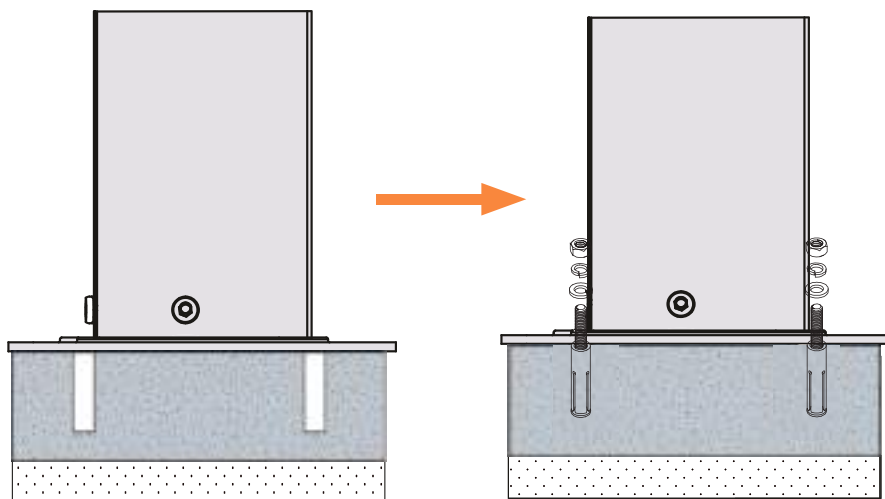

If the deck you are installing is made of hardwood and has a depth exceeding 40mm, you can use ST8*35mm screws to secure it in place. (This hardware is not included with the product, so you will need to purchase it separately.)











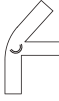

2



The best option is to fix it on a concrete surface. You can use the expansion bolts that are pre-configured with the product to secure it in place.

PARTS

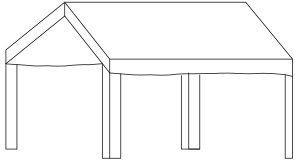
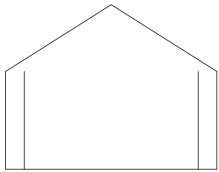
Item no. Nr. N° d'article Articolo No. Artículo No.	Reference Image Referenzbild Image de référence Immagine di riferimento Imagen de referencia	Qty. Menge Qté. Qtà Cant.
1		X15
2		X12
3		X12
4		X12

Item no. Nr. N° d'article Articolo No. Artículo No.	Reference Image Referenzbild Image de référence Immagine di riferimento Imagen de referencia	Qty. Menge Qté. Qtà Cant.
A		X4
B		X8
A1		X2
B1		X4
F		X12

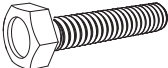
Item no. Nr. N° d'article Articolo No. Artículo No.	Reference Image Referenzbild Image de référence Immagine di riferimento Imagen de referencia	Qty. Menge Qté. Qtà Cant.
a		X85
b	 $\Phi 5$	X56
d		X8
e		X1
f		X2
g		X2

Item no. Nr. N° d'article Articolo No. Artículo No.	Reference Image Referenzbild Image de référence Immagine di riferimento Imagen de referencia	Qty. Menge Qté. Qtà Cant.
m		X24
i	 M6 X 55mm	X12
k	 M6	X12

ASSEMBLY

1

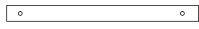

① 15pcs

Ⓐ 4pcs

Ⓑ 8pcs

Ⓐ1 2pcs

Ⓑ1 4pcs

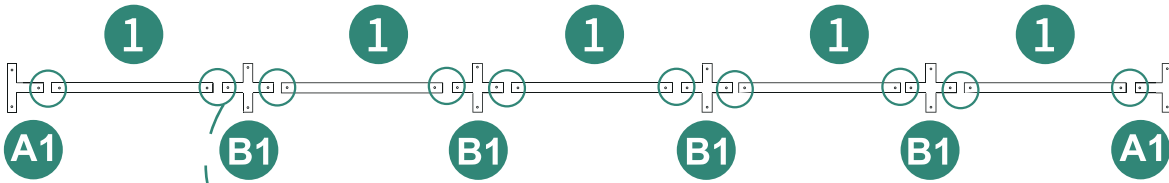
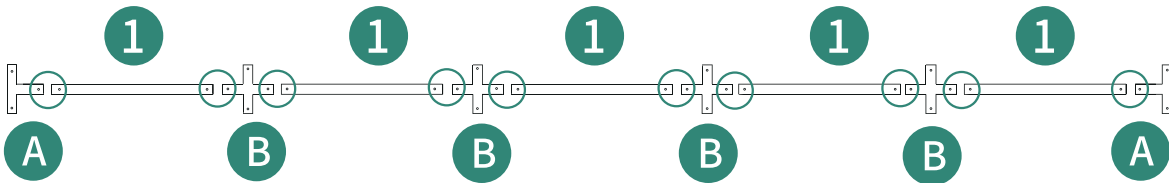

X2

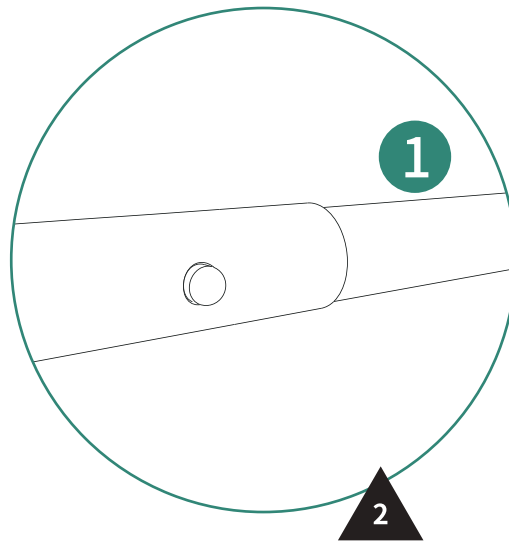
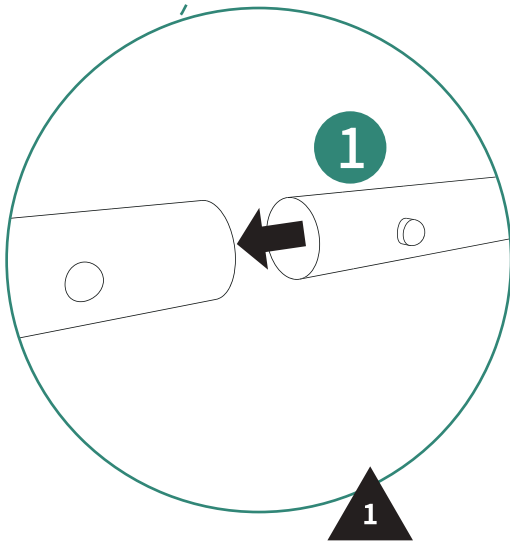

3

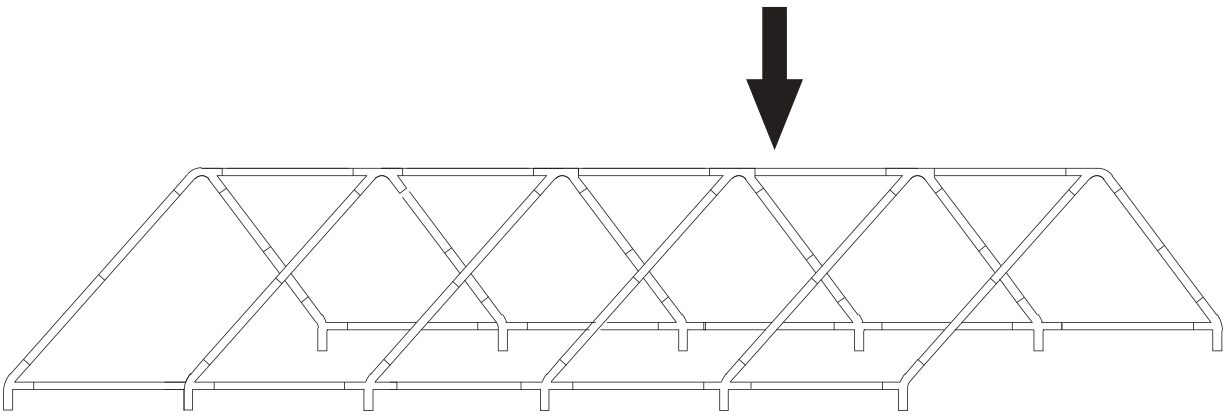
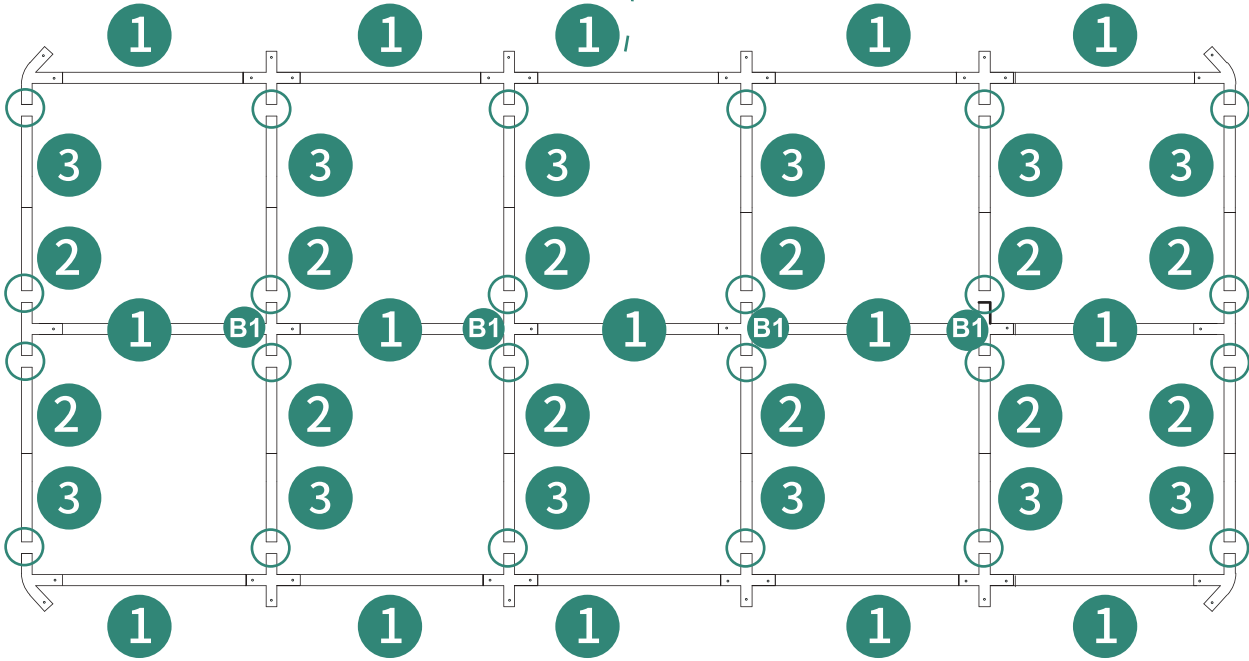
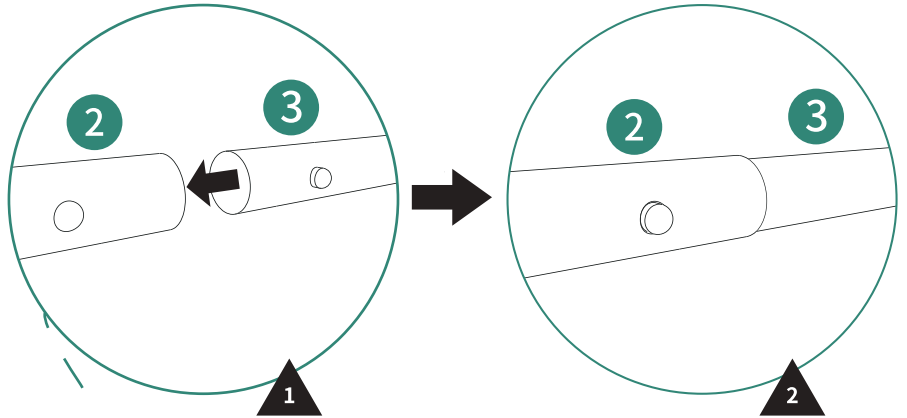

4

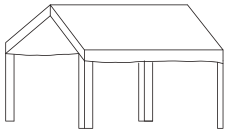

e 1pc

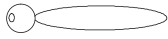

a 72pcs

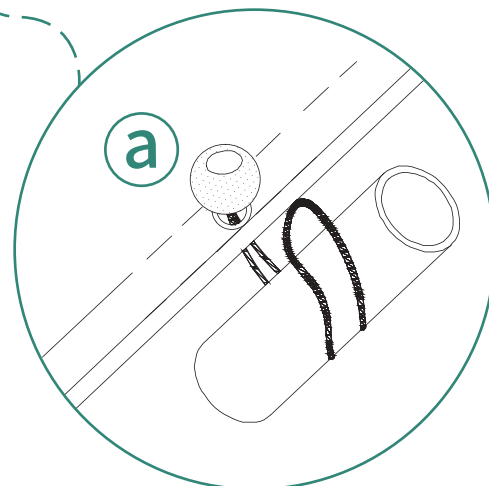
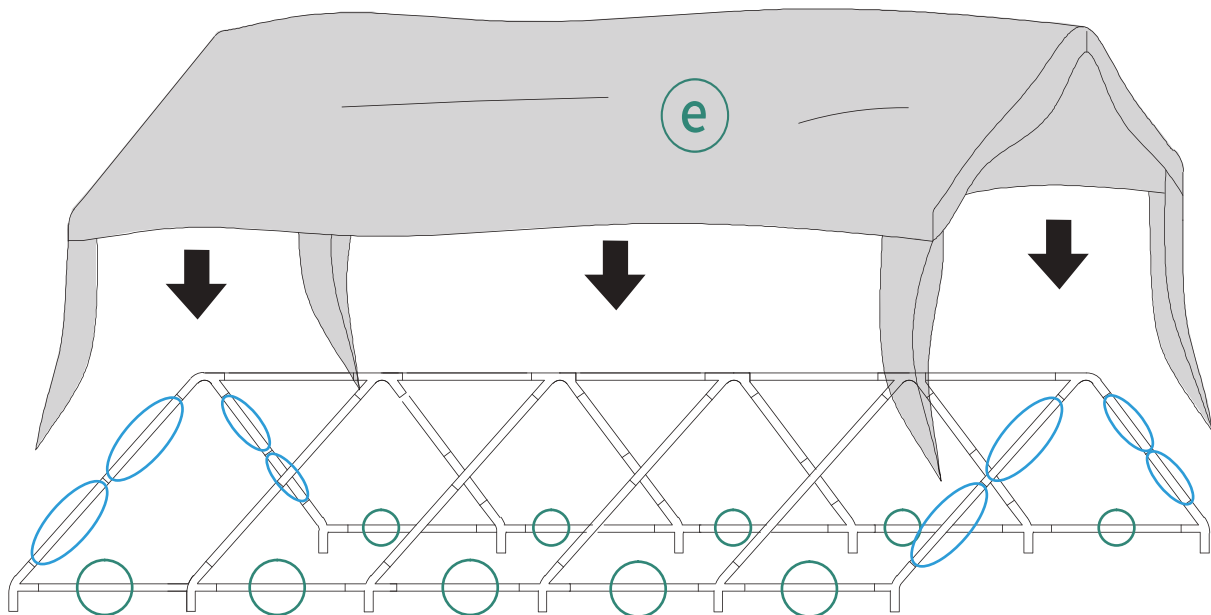

5

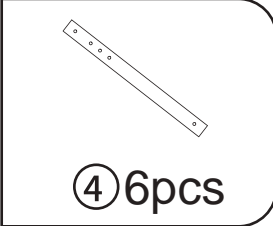

④ 6pcs

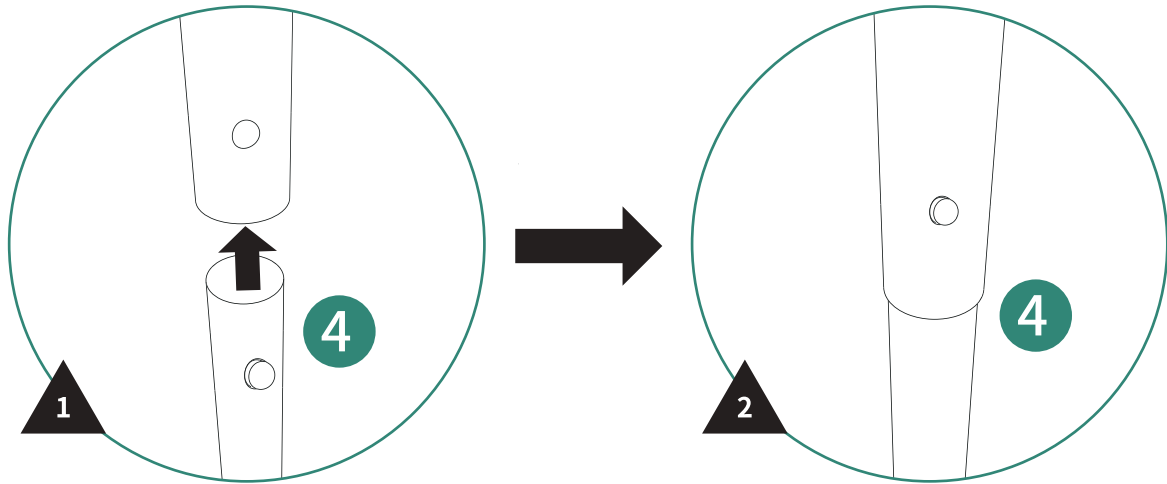
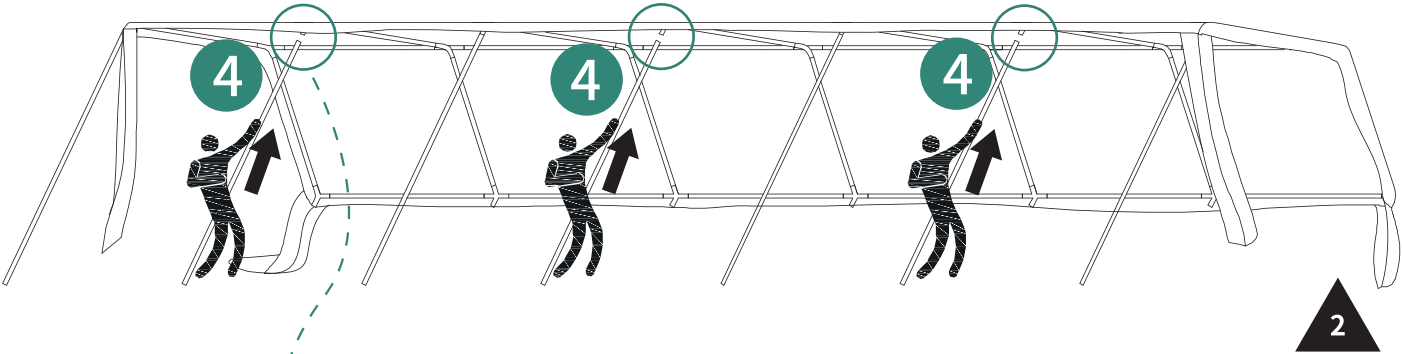
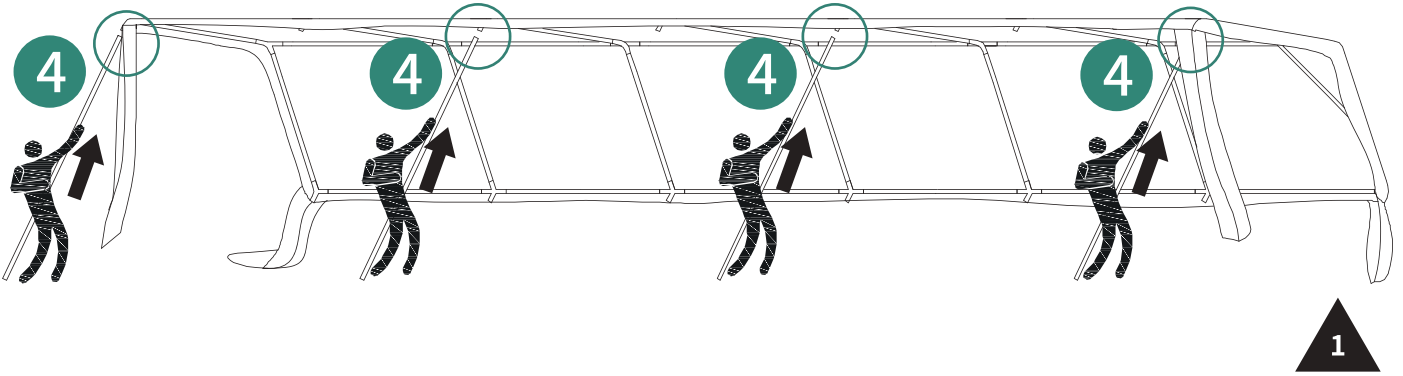

6

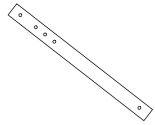

④ 6pcs

1

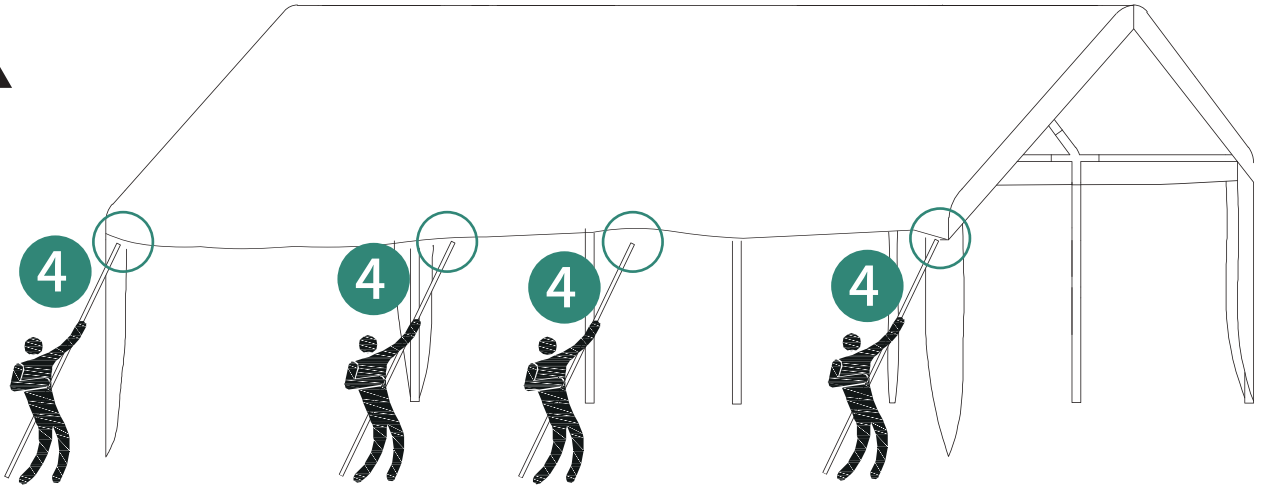

2

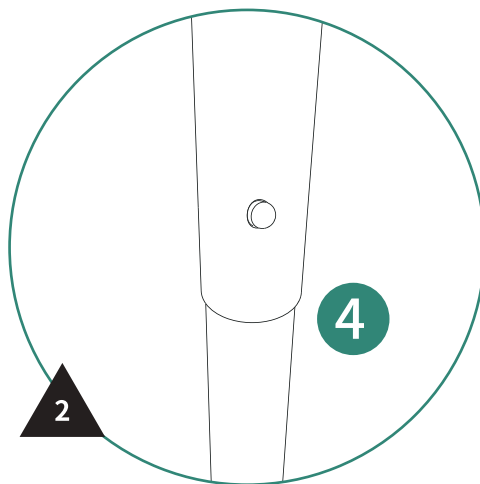
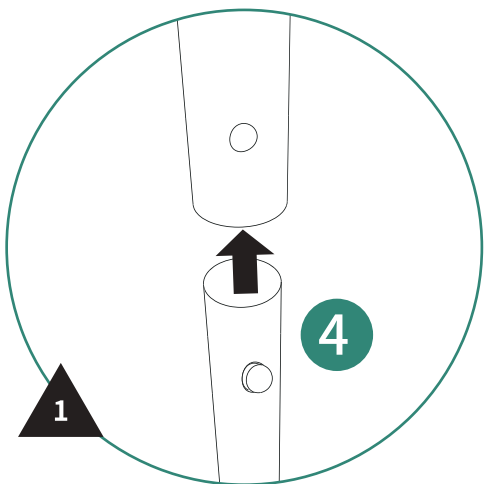
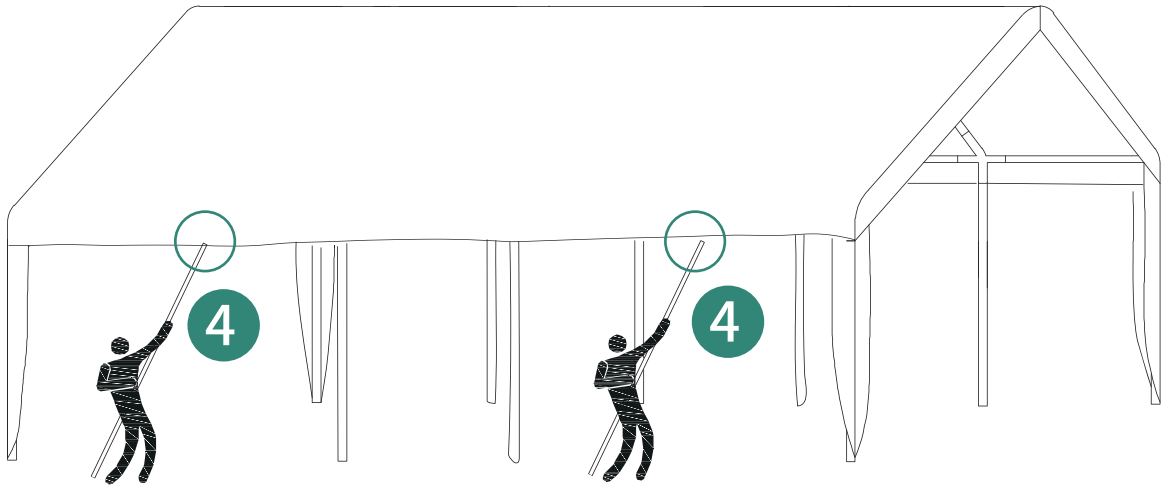

7

M6 X 55mm M6



ⓕ 12pcs ⓘ 12pcs Ⓚ 12pcs

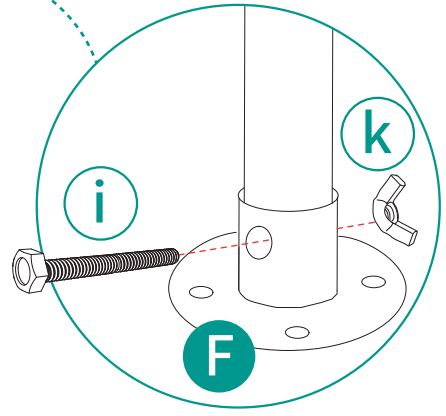
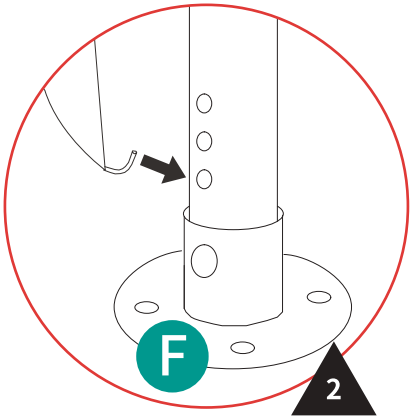
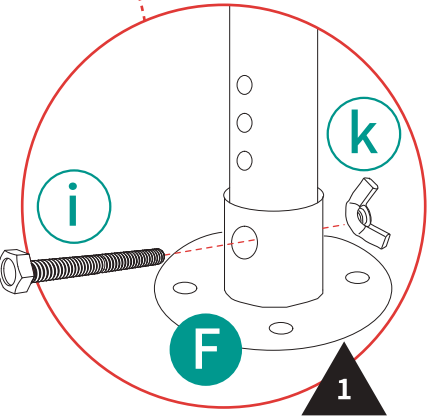
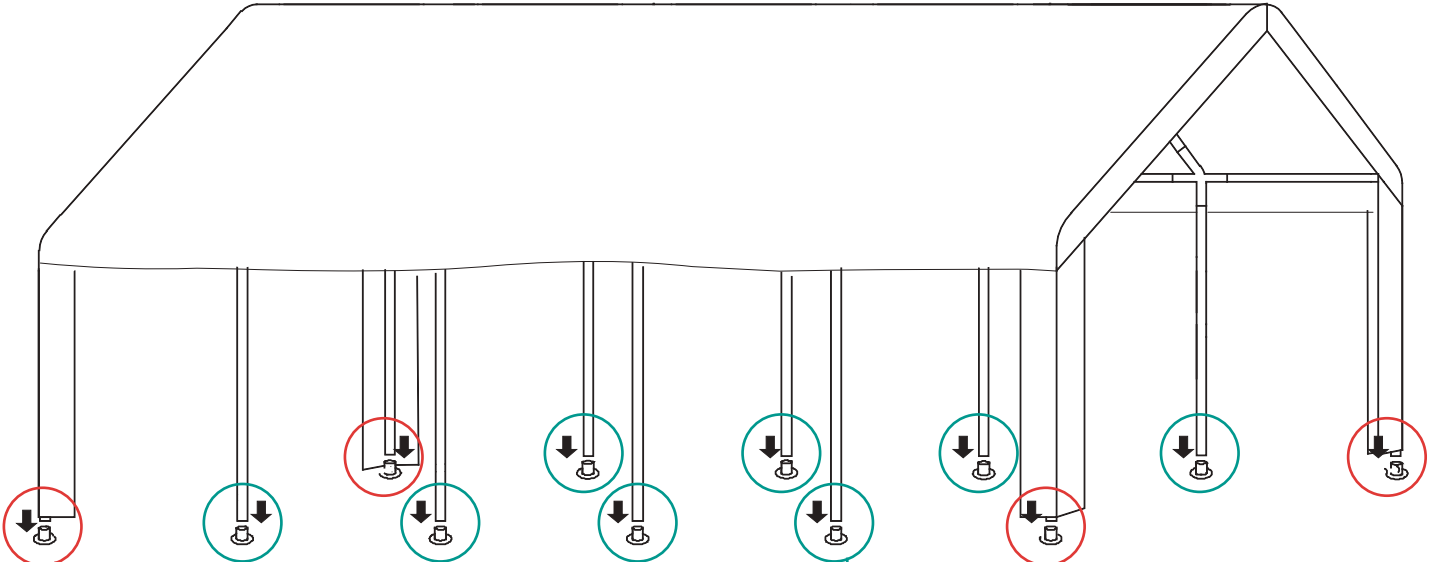

8



Ⓐ 13pcs

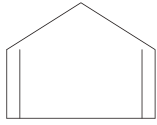

Ⓕ 2pcs



Ⓖ 2pcs

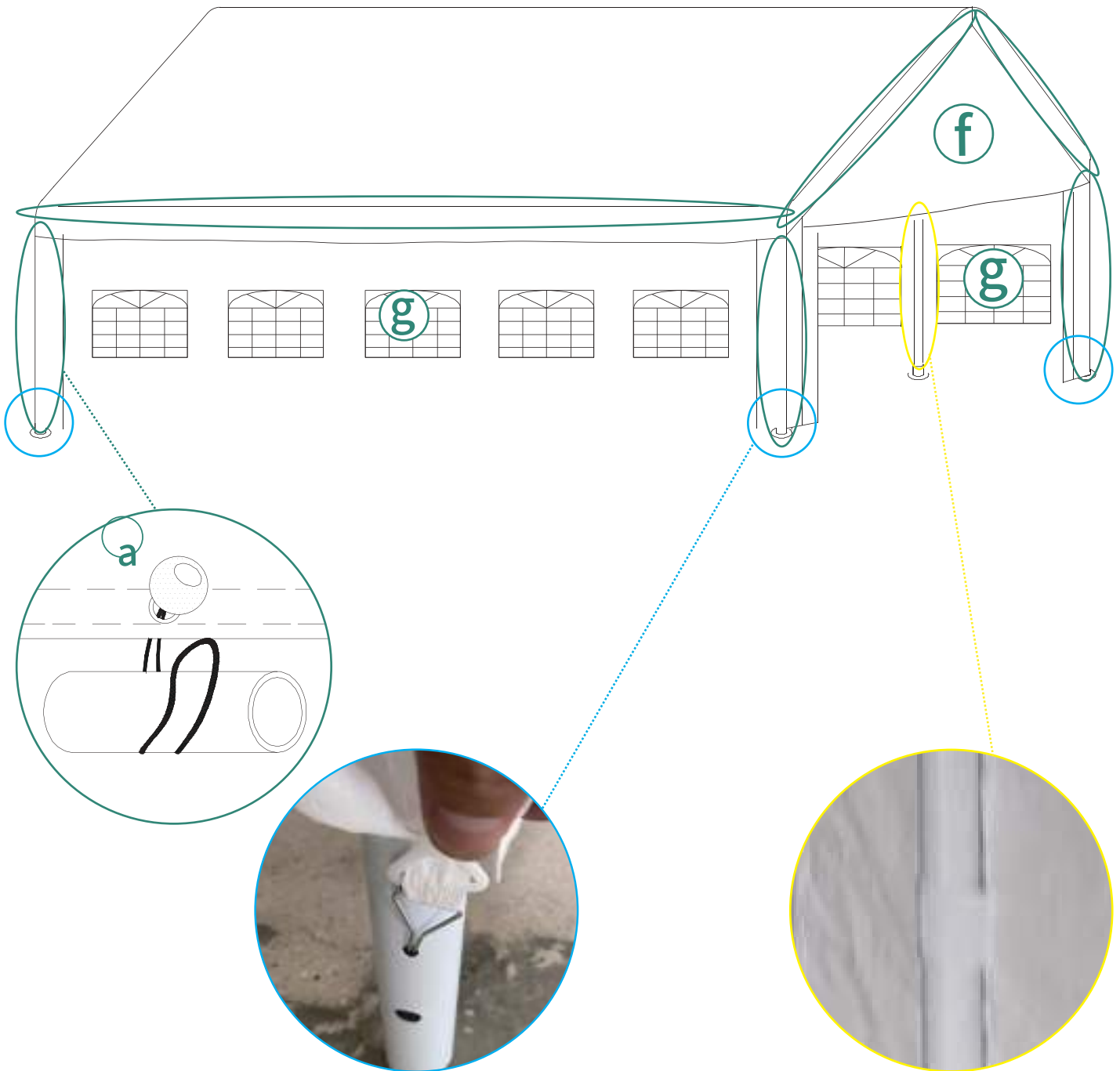

9

$\Phi 5$



(b) 64pcs

(d) 8pcs

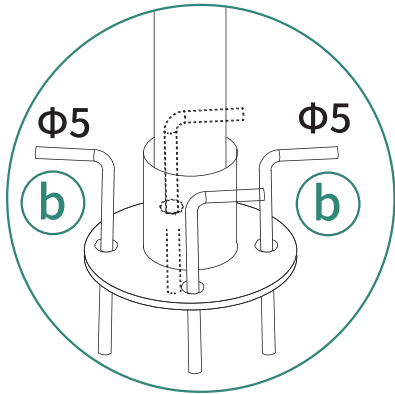
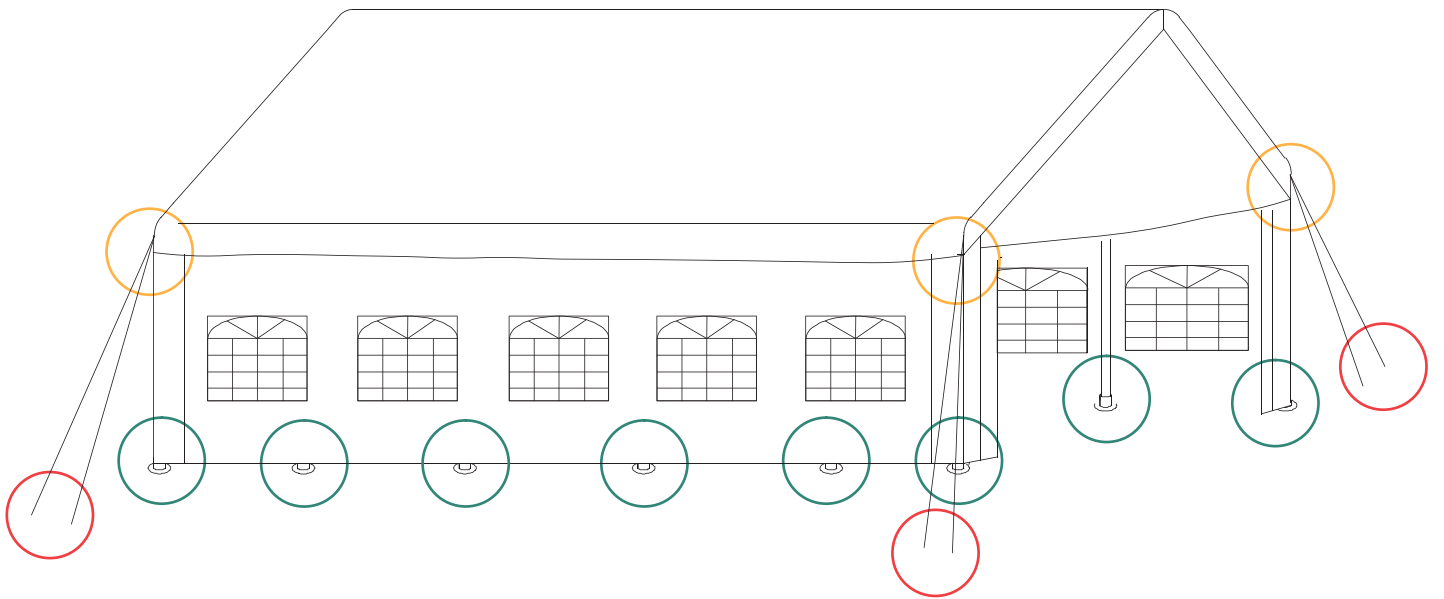

X12

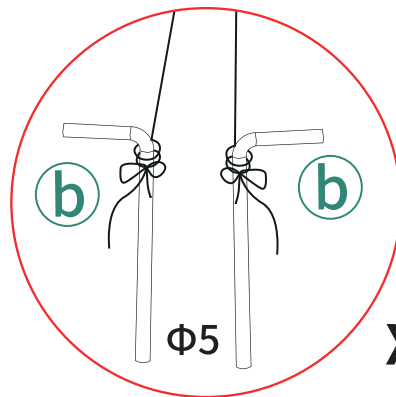

X4

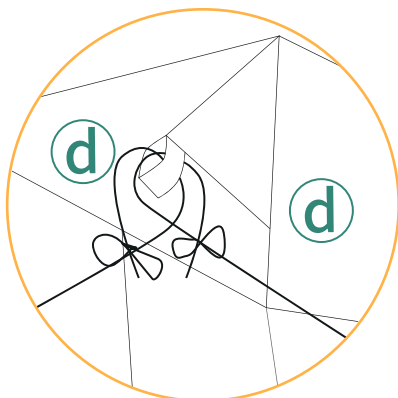

X4

10

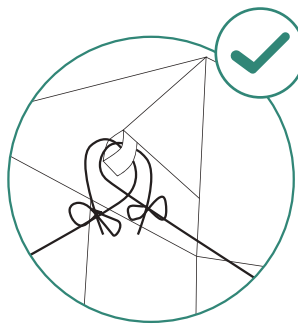
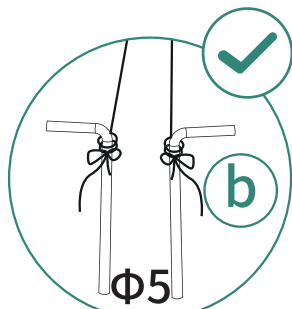
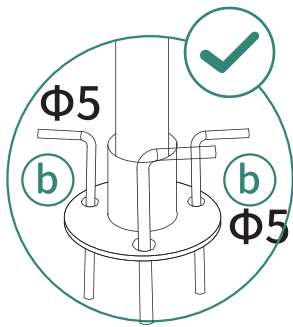

Grassy surfaces

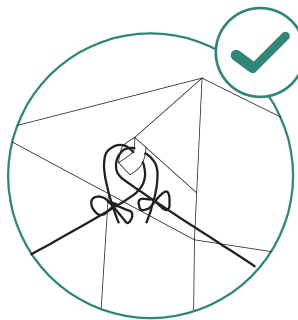
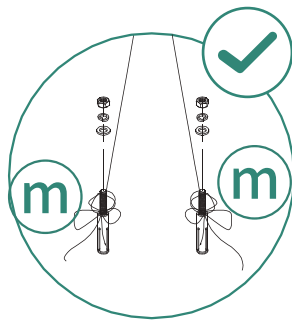
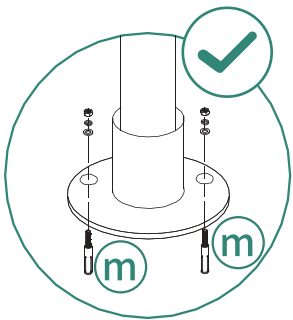

Cement surfaces

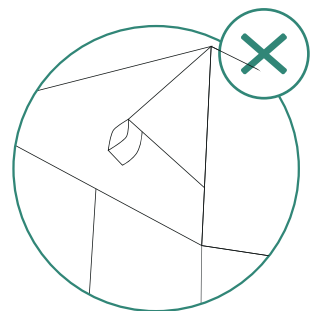
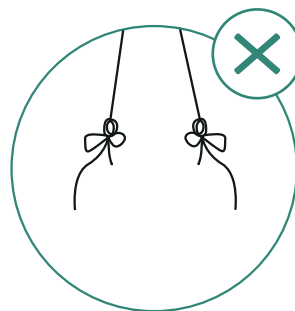
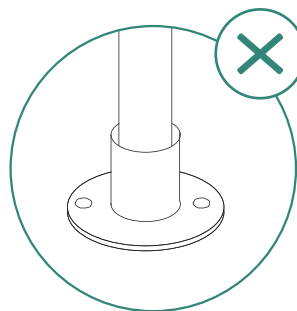

To improve wind resistance, **be sure to complete this installation step.** **If expansion screws or ground nails are not installed, strong winds may topple the gazebo.** Expansion screws are essential for stability on cement surfaces, and ground nails are for grassy surfaces.

11

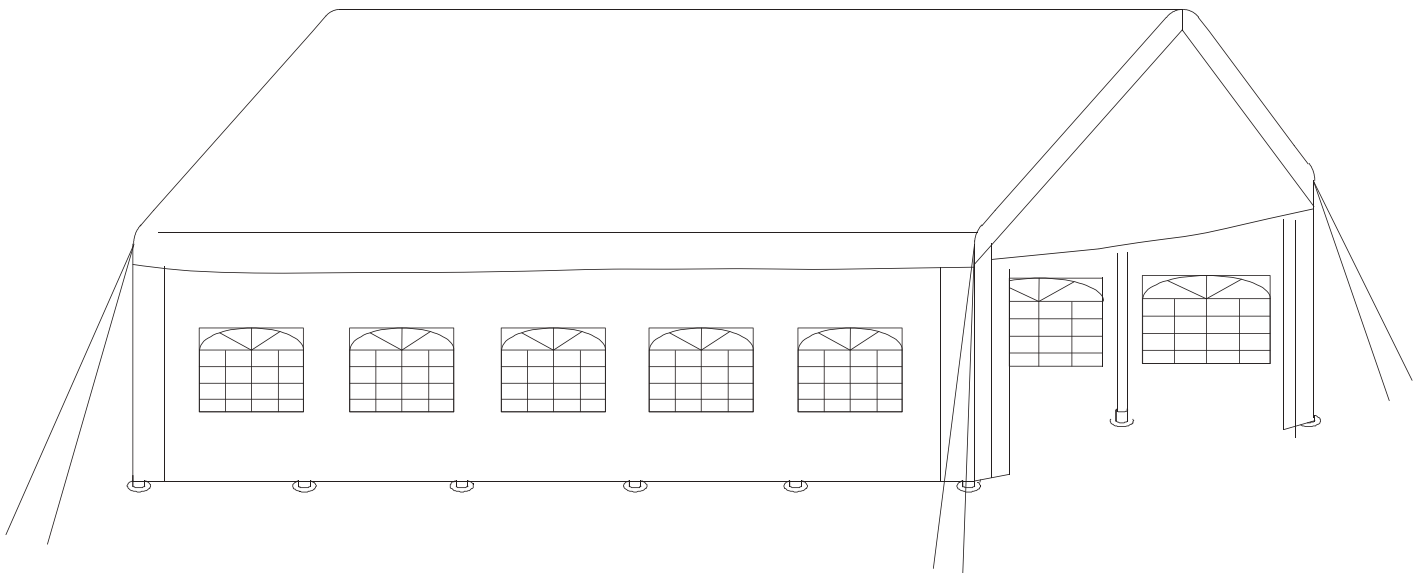

Installation Completed

Installation Abgeschlossen

Installation Complétée

Installazione Completata

Instalación Completada

HELP CENTER



Inquiry



Assembly issue



Missing parts

If you encounter any difficulties during assembly, please contact us.

Wenn Sie während der Montage auf Schwierigkeiten stoßen, kontaktieren Sie uns bitte.

Si vous rencontrez des difficultés lors du montage, veuillez nous contacter.

Se incontri difficoltà durante il montaggio, ti preghiamo di contattarci.

Si encuentras alguna dificultad durante el ensamblaje, por favor contáctanos.

DISCLAIMER

Manufacturer and seller expressly disclaim any and all liability for personal injury, property damage or loss, whether direct, indirect, or incidental, resulting from the incorrect attachment, improper use, inadequate maintenance, unapproved modification, or neglect of this product.

Der Hersteller und Verkäufer lehnen ausdrücklich jegliche Haftung für Personenschäden, Sachschäden oder Verluste ab, egal ob direkt, indirekt oder zufällig, die durch falsche Anbringung, unsachgemäßen Gebrauch, unzureichende Wartung, nicht genehmigte Änderungen oder Vernachlässigung dieses Produkts entstehen.

El fabricante y vendedor renuncian expresamente a toda responsabilidad por lesiones personales, daños materiales o pérdidas, ya sean directos, indirectos o incidentales, derivados de la incorrecta colocación, uso inadecuado, mantenimiento insuficiente, modificación no aprobada o negligencia de este producto.

Il produttore e il venditore declinano espressamente ogni responsabilità per lesioni personali, danni materiali o perdite, dirette, indirette o incidentali, derivanti dall'errato fissaggio, uso improprio, manutenzione inadeguata, modifica non autorizzata o negligenza di questo prodotto.

Le fabricant et le vendeur déclinent expressément toute responsabilité en cas de blessures corporelles, de dommages matériels ou de pertes, qu'ils soient directs, indirects ou accessoires, résultant de la fixation incorrecte, de l'utilisation inappropriée, de l'entretien insuffisant, de la modification non approuvée ou de la négligence de ce produit.

