

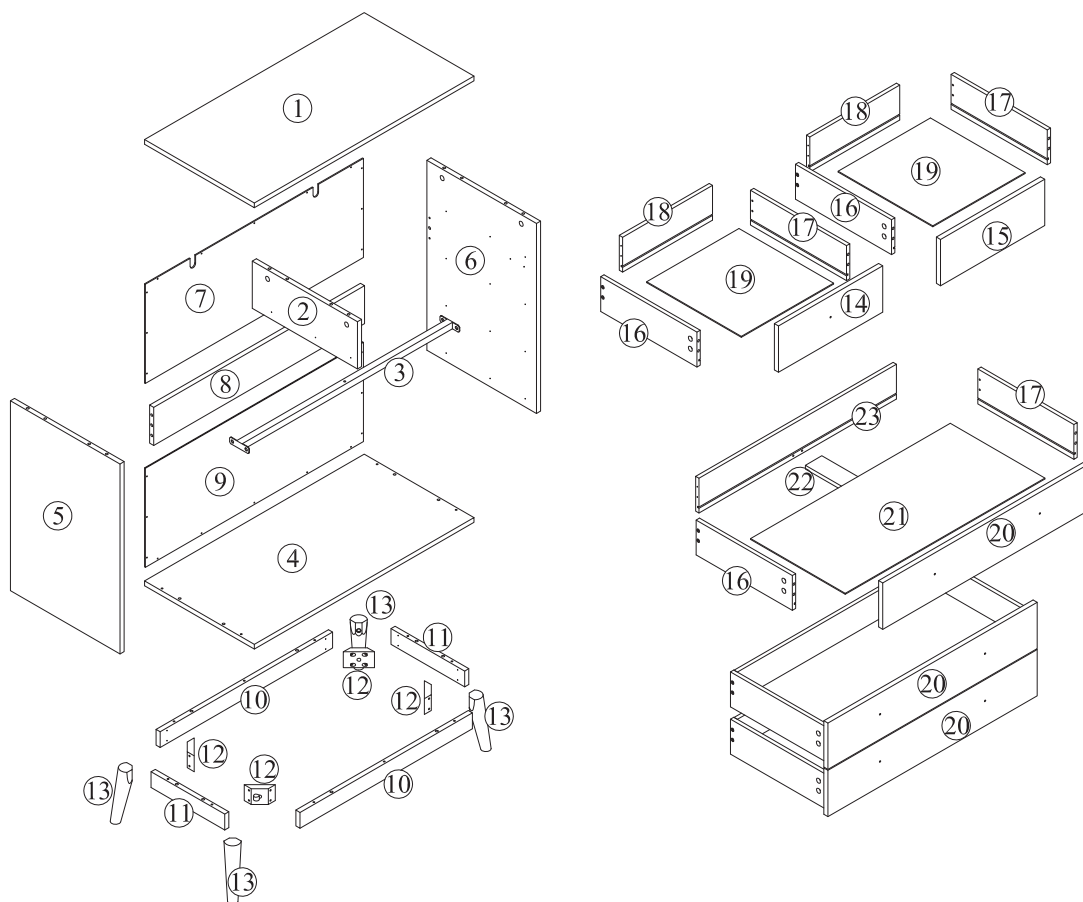

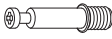









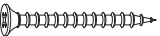



READ AND SAVE THIS INSTRUCTIONS FOR FUTURE USE



Tools Recommended

# ASSEMBLY INSTRUCTION

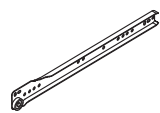
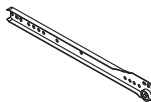
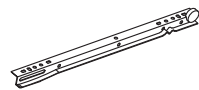
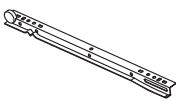

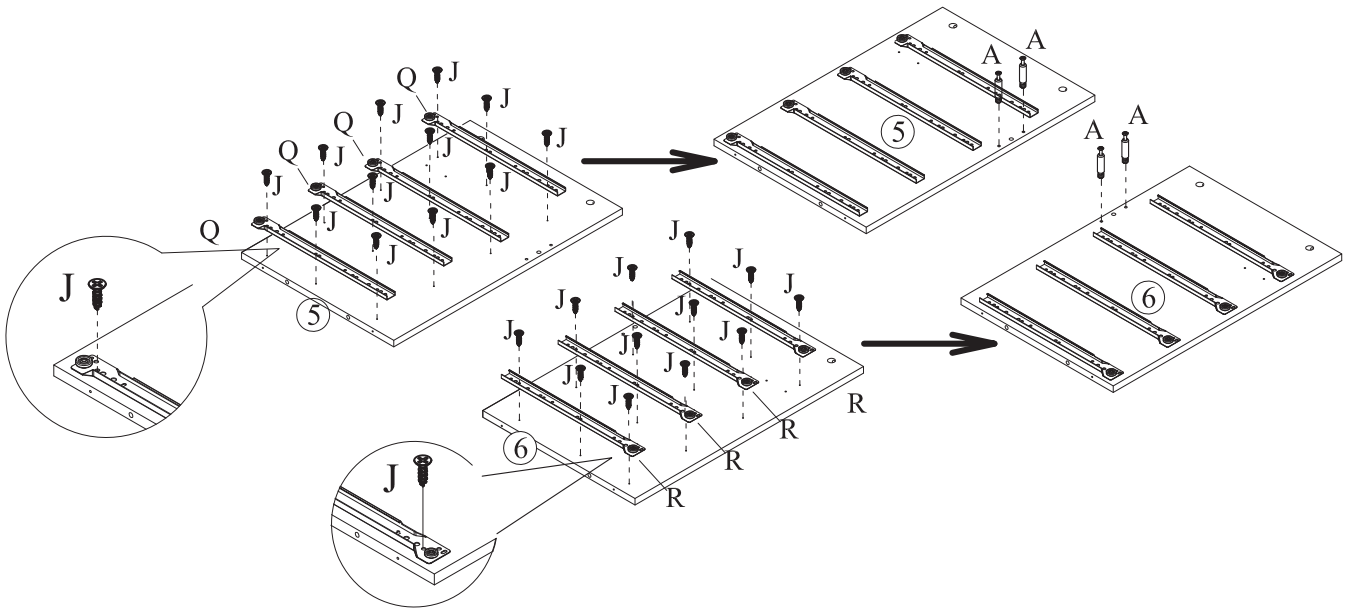

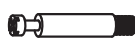
<p>A</p> <p>x 33</p>  <p>Φ6X35mm</p>	<p>B</p> <p>x 33</p>  <p>Φ15X9mm</p>	<p>C</p> <p>x 30</p>  <p>M4x35mm</p>	<p>D</p> <p>x 23</p>  <p>Φ6x30mm</p>	<p>E</p> <p>x 11</p>  <p>M4x45mm</p>
<p>F</p> <p>x 16</p>  <p>M4x25mm</p>	<p>G</p> <p>x 4</p>  <p>M8x50mm</p>	<p>H</p> <p>x 1</p> 	<p>I</p> <p>x 4</p> 	<p>J</p> <p>x 60</p>  <p>M3.5x14mm</p>
<p>K</p> <p>x 4</p> 	<p>L</p> <p>x 4</p>  <p>M4x16mm</p>	<p>M</p> <p>x 2</p> 	<p>N</p> <p>x 22</p>  <p>M3x12mm</p>	<p>O</p> <p>x 8</p>  <p>M4x16mm</p>
<p>P</p> <p>x 8</p> 	<p>Q</p> <p>x 5</p> 	<p>R</p> <p>x 5</p> 	<p>S</p> <p>x 5</p> 	<p>T</p> <p>x 5</p> 

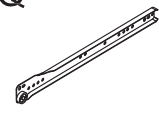
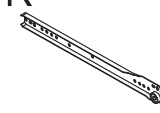

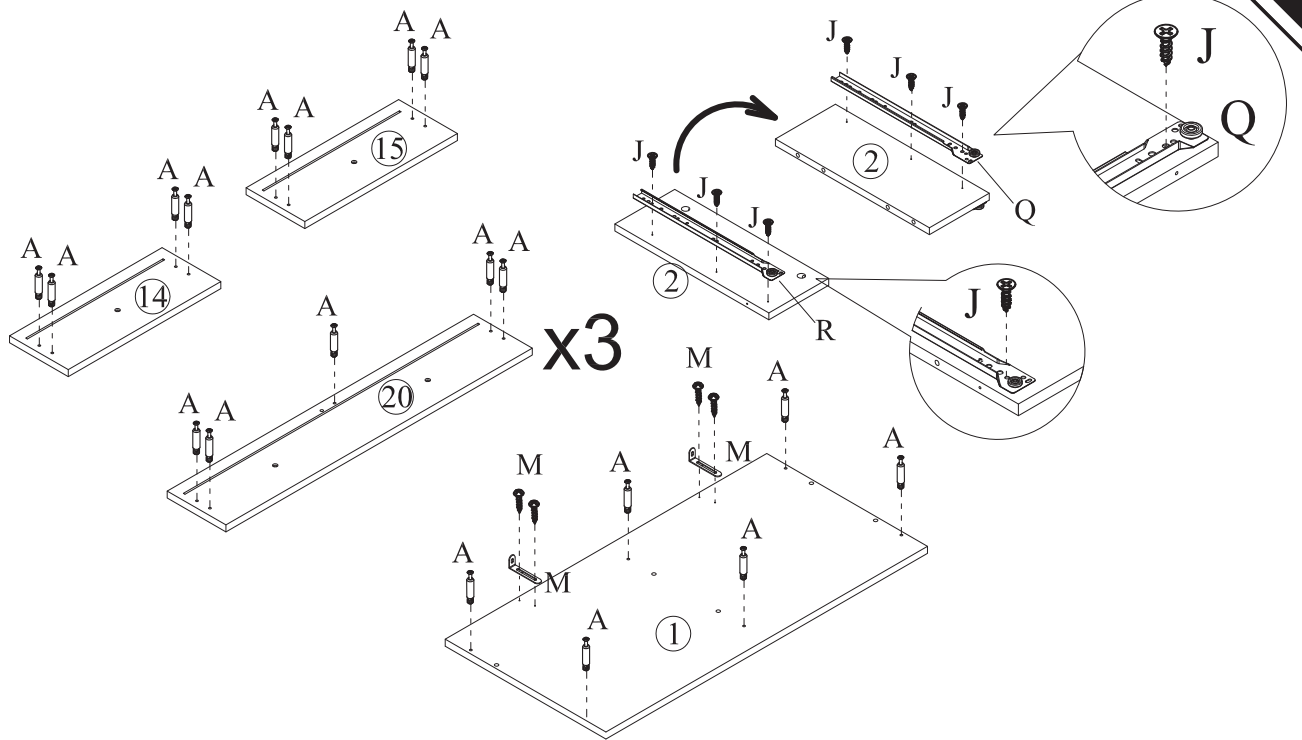
- |   |   |   |   |
|---|---|---|---|
| <p>A</p>  <p>x4</p> | <p>J</p>  <p>x24</p> | <p>Q</p>  <p>x4</p> | <p>R</p>  <p>x4</p> |
|---|---|---|---|

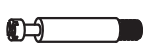

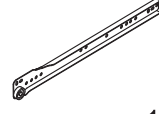
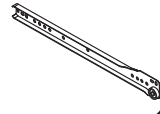
- |   |  |   |  |  |
|---|--|---|--|--|
| <p>A</p>  <p>x29</p> | <p>J</p>  <p>x6</p> | <p>M</p>  <p>x2</p> | <p>Q</p>  <p>x1</p> | <p>R</p>  <p>x1</p> |
|---|--|---|--|--|

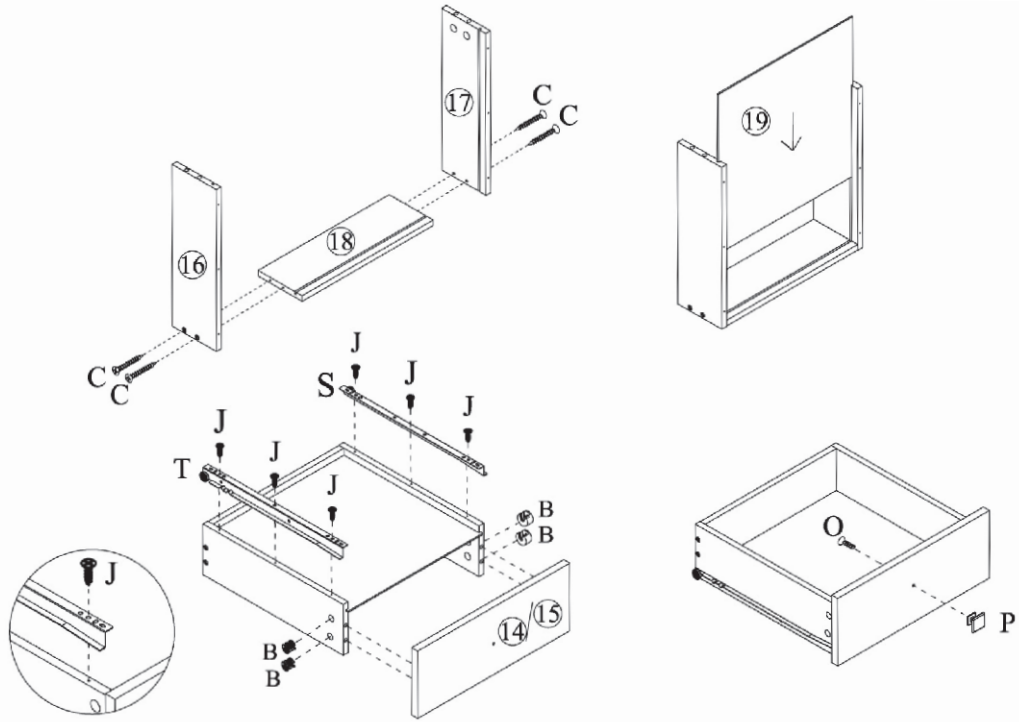

x2

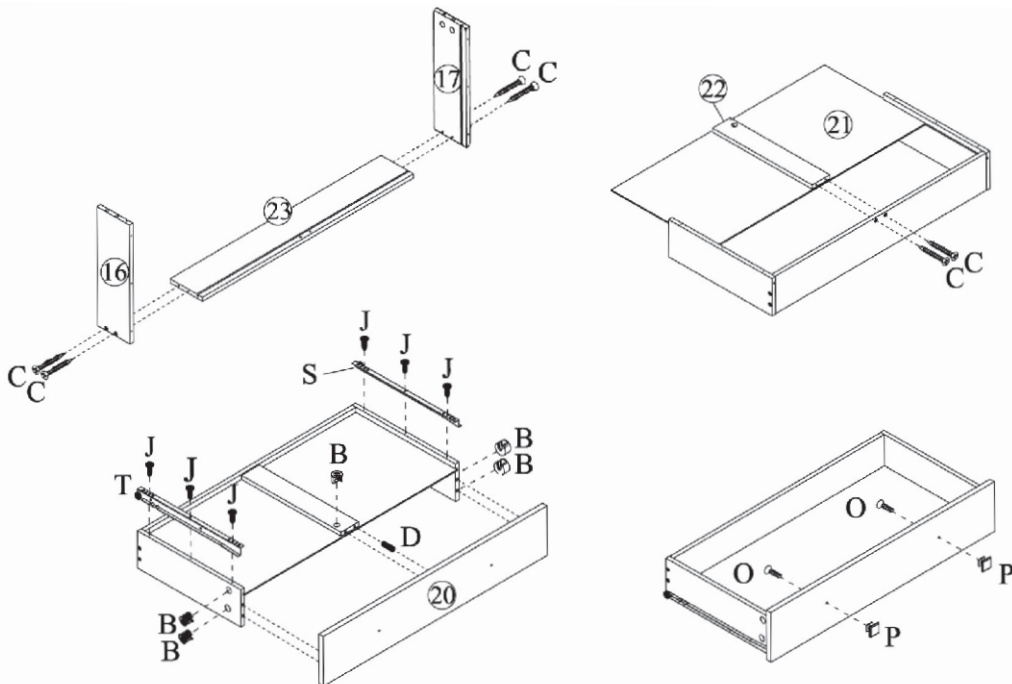
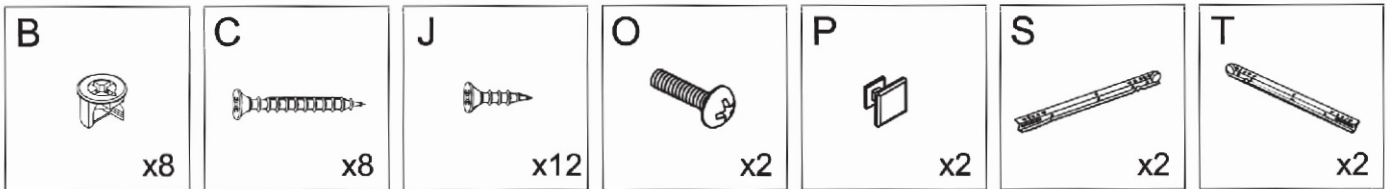

x3

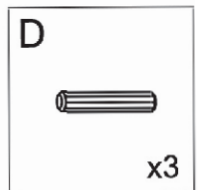
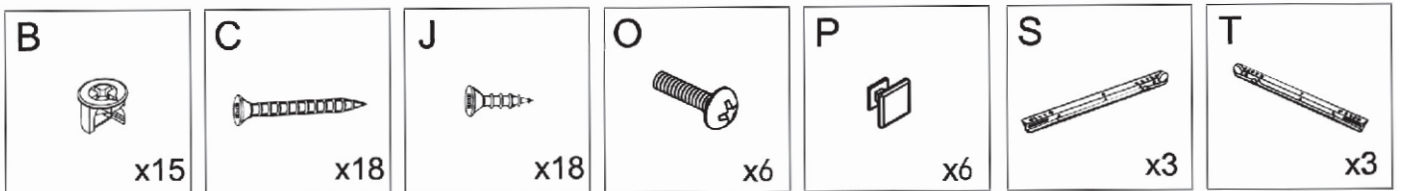

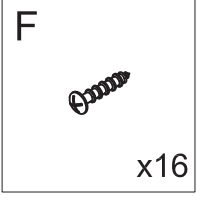
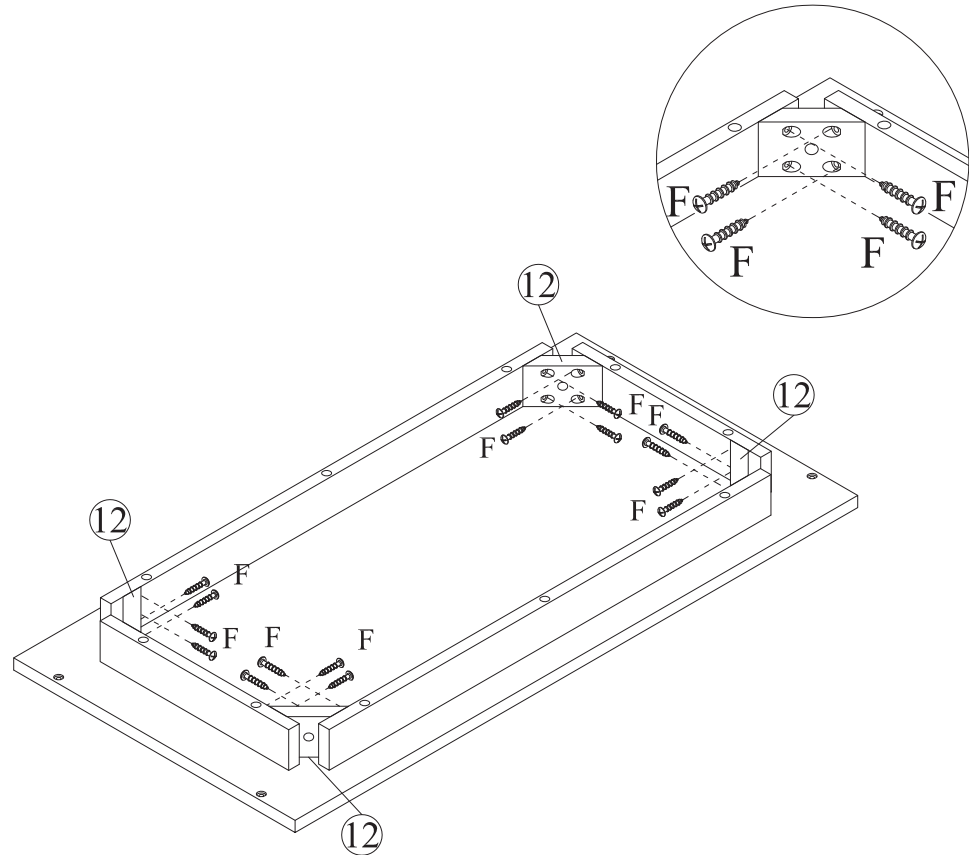
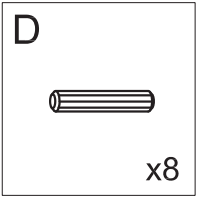
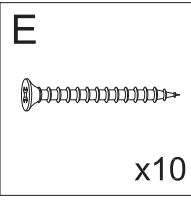
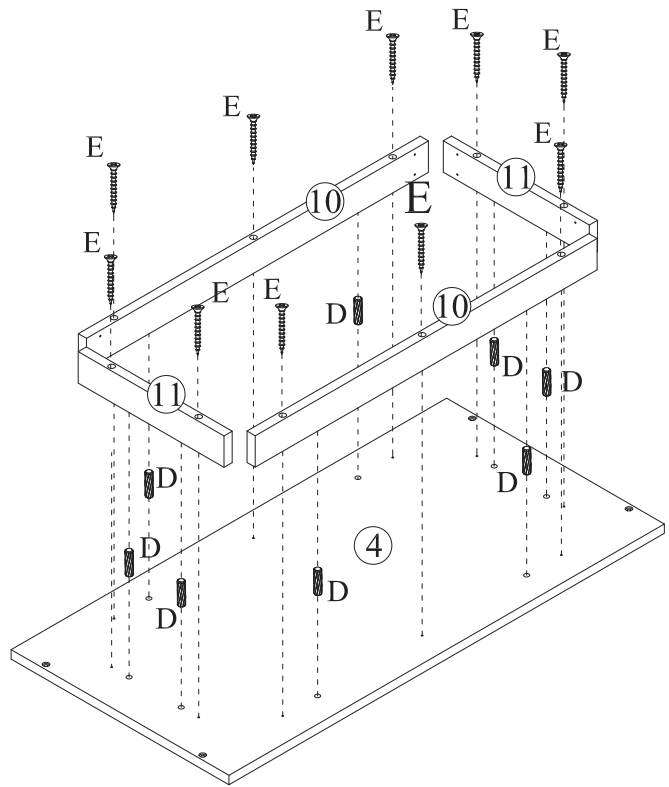

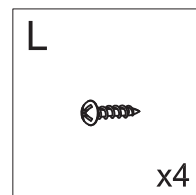
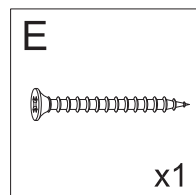
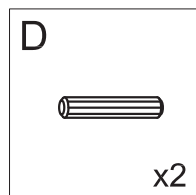
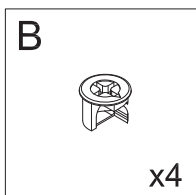
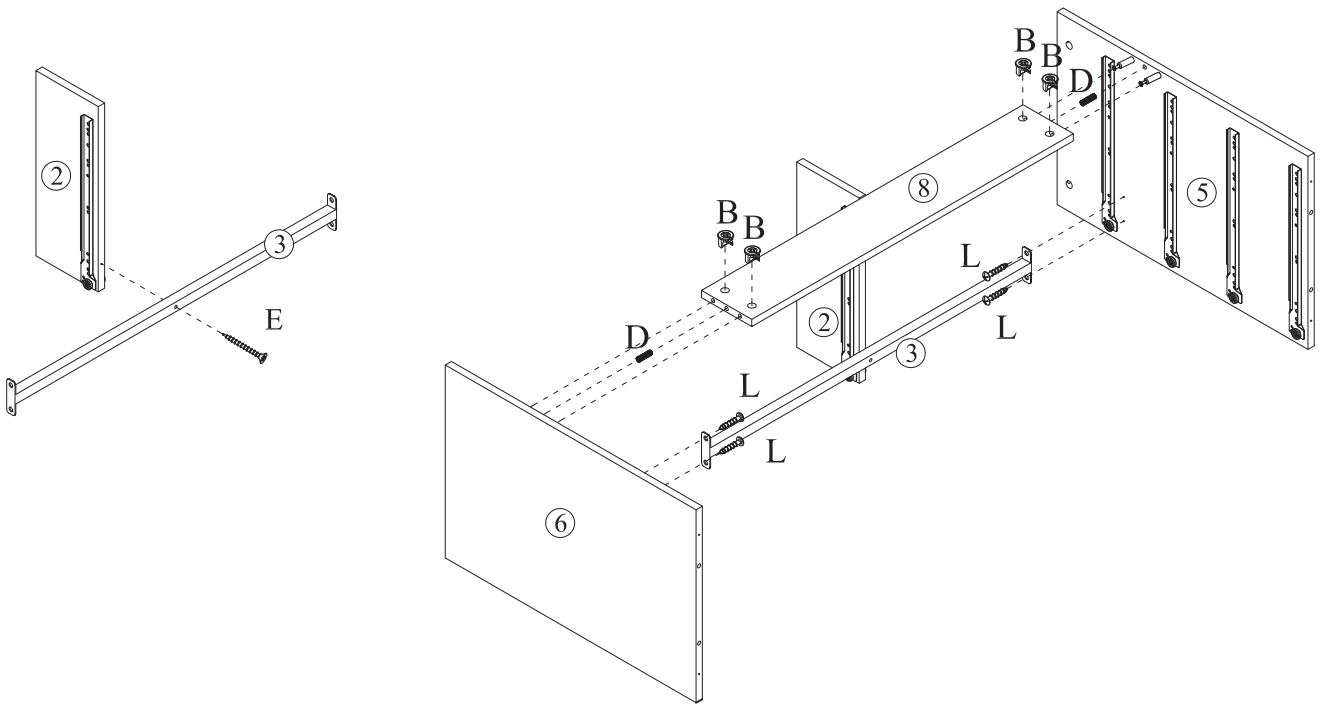
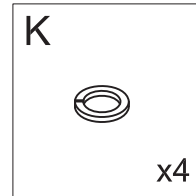
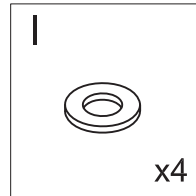
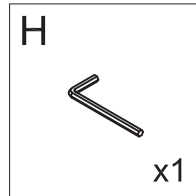
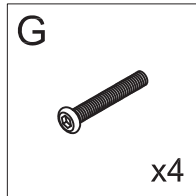
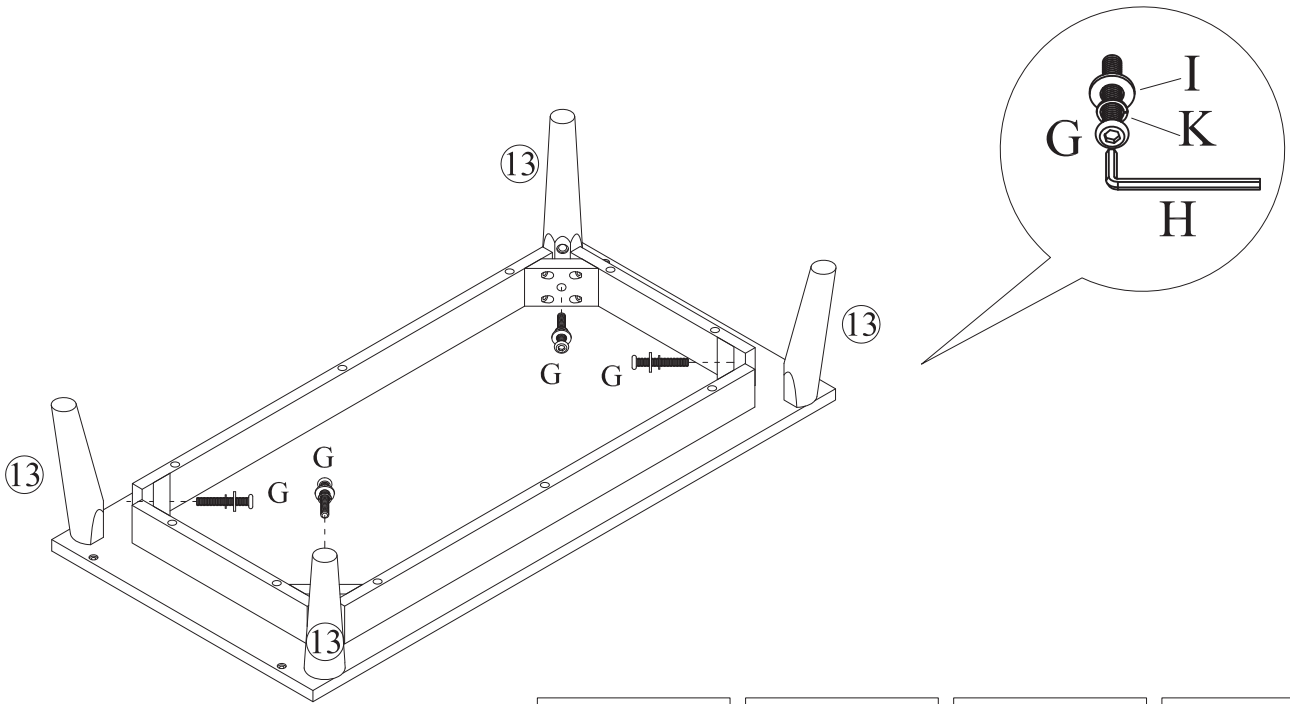

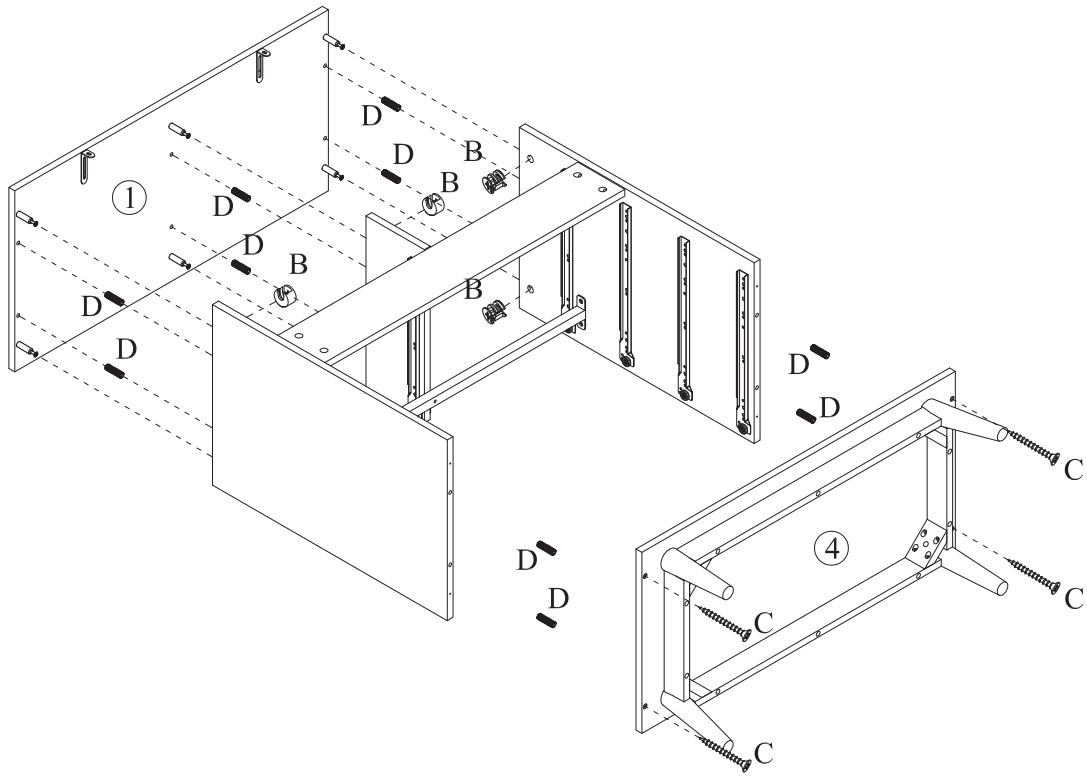

**B**

x6

**C**

x4

**D**

x10

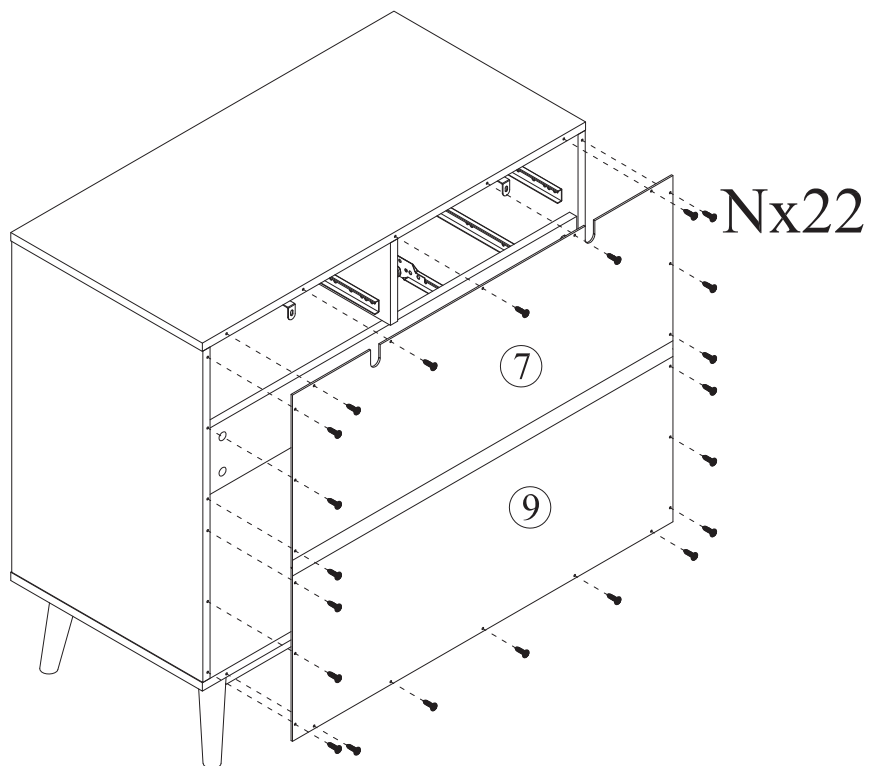

**N**

x22

