

# Assembly Instructions

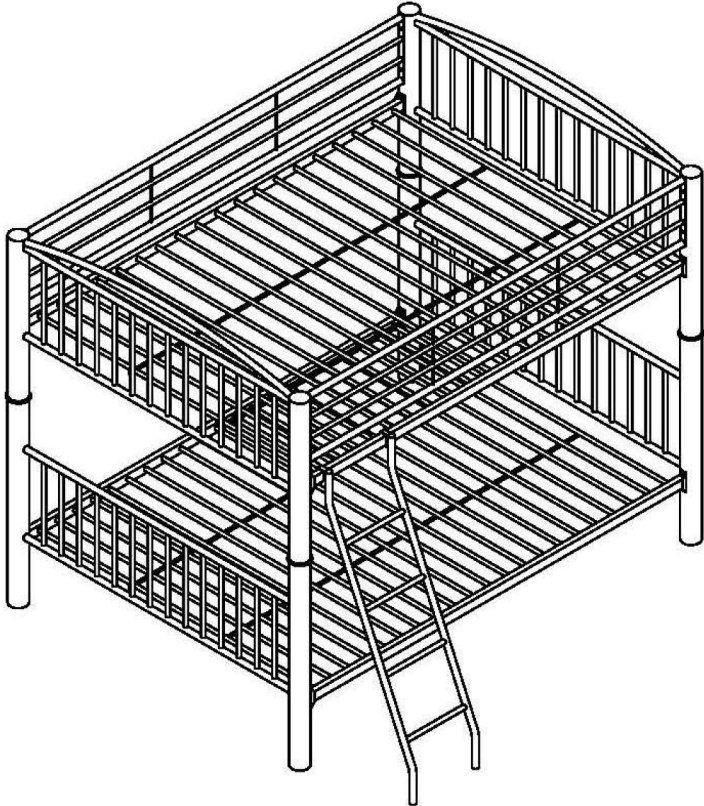

## ASSEMBLY RATING

The Assembly Rating is a 5-point system that shows the degree of effort needed in assembling a specific product (with 1 being easy and 5 being difficult). For some products, two persons are recommended.

EASY  DIFFICULT

## Tools Required for Assembly:

Allen Wrench



2 PERSONS RECOMMENDED

# ASSEMBLY & CARE ADVICE

FOR YOUR FURNITURE TO LAST, CORRECT ASSEMBLY AND PROPER MAINTENANCE ARE NECESSARY. PLEASE FOLLOW THE INFORMATION PROVIDED BELOW TO FULLY ENJOY YOUR FURNITURE.

## BASIC ASSEMBLY TECHNIQUES

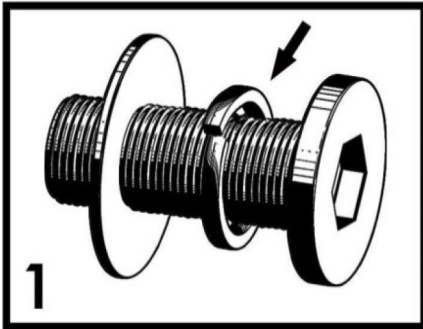

1 When lock or spring washer is used in an assembly, please make sure the lock or spring washer is placed between the larger flat washer and the head of the screw or bolt.



2 Position each part correctly and insert screws or bolts into their respective holes by hand tighten or using the proper hand tool. Only tighten when step is completed or when instructed to do so.

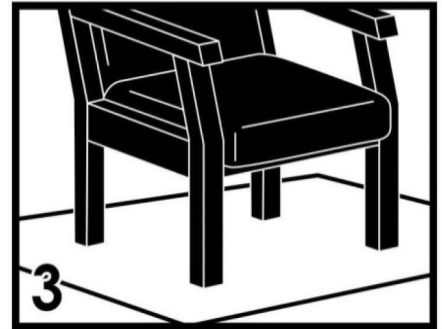

3 Use cardboard or carpet area when assembling furniture to prevent scratches. Make sure the furniture rests on a flat and level surface with each leg evenly touching the floor.

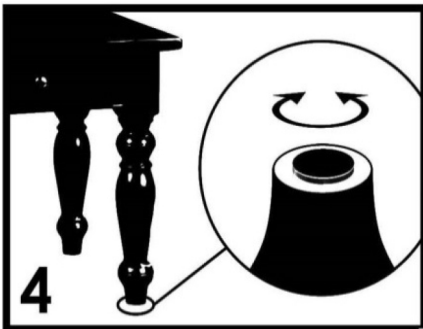

4 Some furniture comes with height adjustment knobs underneath each leg. To lower or to raise each leg, you need to turn clockwise or counterclockwise, respectively.

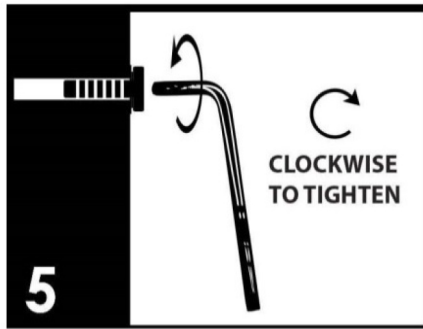

5 Make sure all parts are properly aligned, then use the appropriate hand tool to completely tighten the bolts or screws. Do not use power tools and do not overtighten.

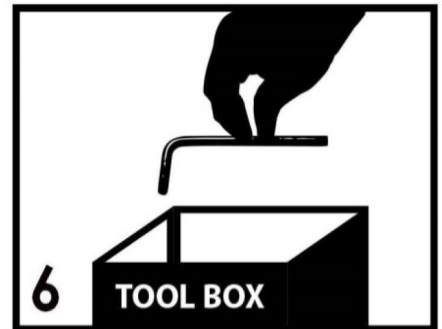

6 Save the instructions and store the Allen wrench or any supplied tool for later maintenance. After two weeks, check and tighten any loose hardware and repeat again every six months thereafter.

IT IS THE USER'S RESPONSIBILITY TO MAINTAIN THE FURNITURE. THE HARDWARE MAY LOOSEN OVER TIME AND MAY CAUSE THE FURNITURE TO BE WOBBLY AND UNABLE TO SUPPORT ITS INTENDED WEIGHT CAPACITY. THIS MAY LEAD TO COLLAPSE AND MAY CAUSE SERIOUS INJURY.



FAILURE TO FOLLOW THE GUIDELINES ABOVE MAY RESULT IN INJURY AND/OR PROPERTY DAMAGE.

# PARTS LIST

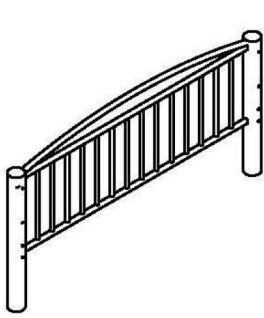

TOP HEADBOARD &  
FOOTBOARD  
① X2PCS

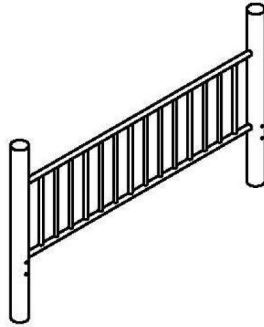

BOTTOM HEADBOARD &  
FOOTBOARD  
② X2PCS

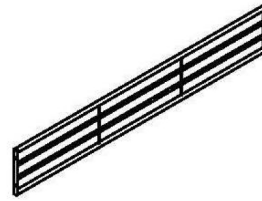

GUARDRAIL  
③ X2PCS

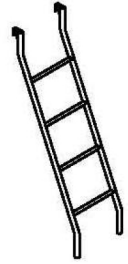

LADDER  
④ X1PC

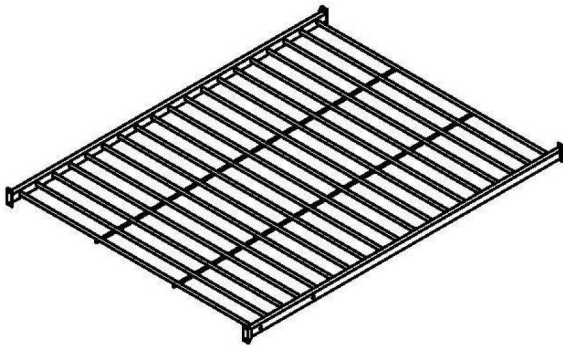

TOP BASE FRAME  
⑤ X1PC

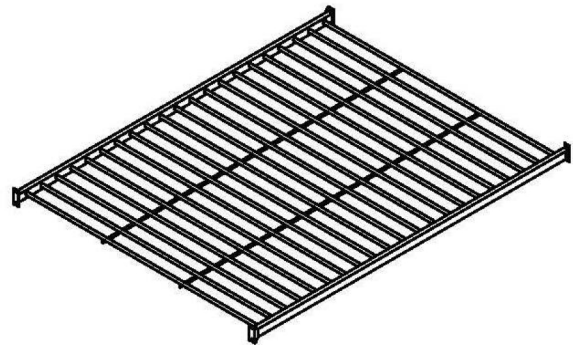









BOTTOM BASE FRAME  
⑥ X1PC

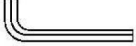

POST CONNECTOR  
⑦ X4PCS

# HARDWARE LIST

(A)		BOLT 1/4"X1 <sup>3</sup> / <sub>4</sub> "	2PCS	(F)		WASHER $\phi$ 18mm	16PCS
(B)		BOLT 1/4"X <sup>3</sup> / <sub>4</sub> "	8PCS	(G)		WASHER $\phi$ 13mm	16PCS
(C)		BOLT 5/16"X <sup>3</sup> / <sub>4</sub> "	16PCS	(H)		ALLEN WRENCH 4X4mm	1PC
(D)		WASHER $\phi$ 16mm	10PCS	(I)		ALLEN WRENCH 5X5mm	1PC
(E)		WASHER $\phi$ 11mm	10PCS	(J)		PLASTIC CAP $\phi$ 3"	8PCS (only to be used when beds are separated)

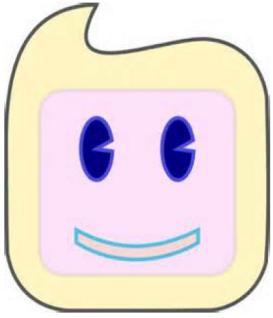

Before you begin, please read Page 2 of "Assembly and Care Advice" AND Page 11 of "Safety Warnings".

And remember, do not tighten until each step is completed or instructed.

MD

### STEP 1: TOP BUNK ASSEMBLY

#### ASSEMBLY

Do not fully tighten all bolts until assembly is complete. This will help all parts to assemble properly.

C		8PCS
F		8PCS
G		8PCS
I		

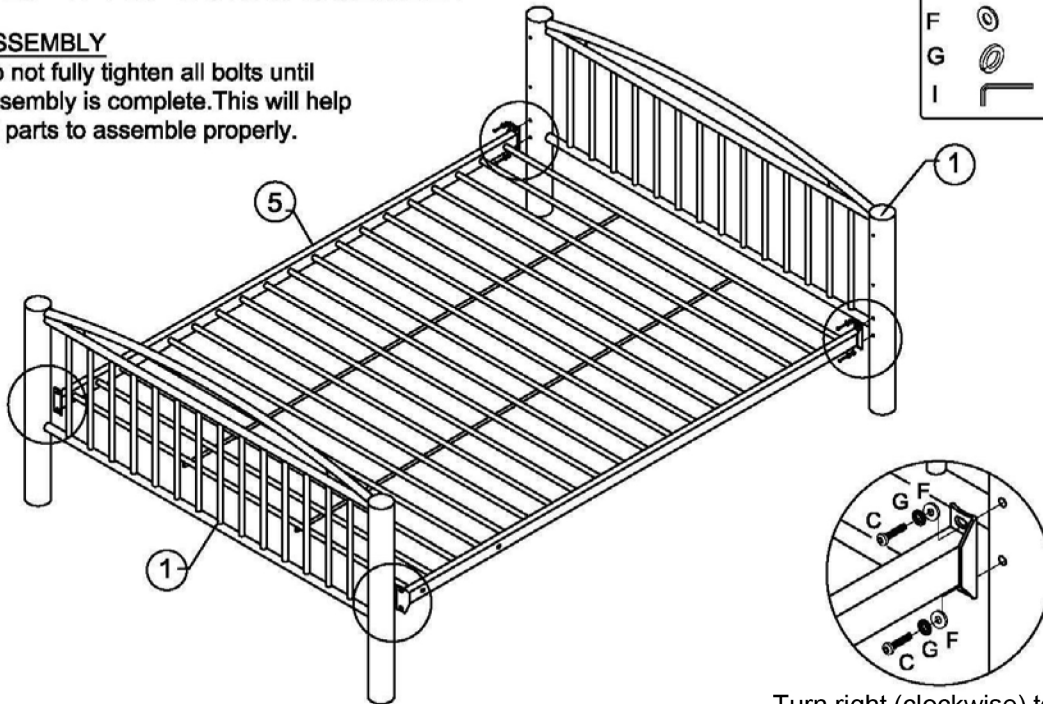

Turn right (clockwise) to tighten



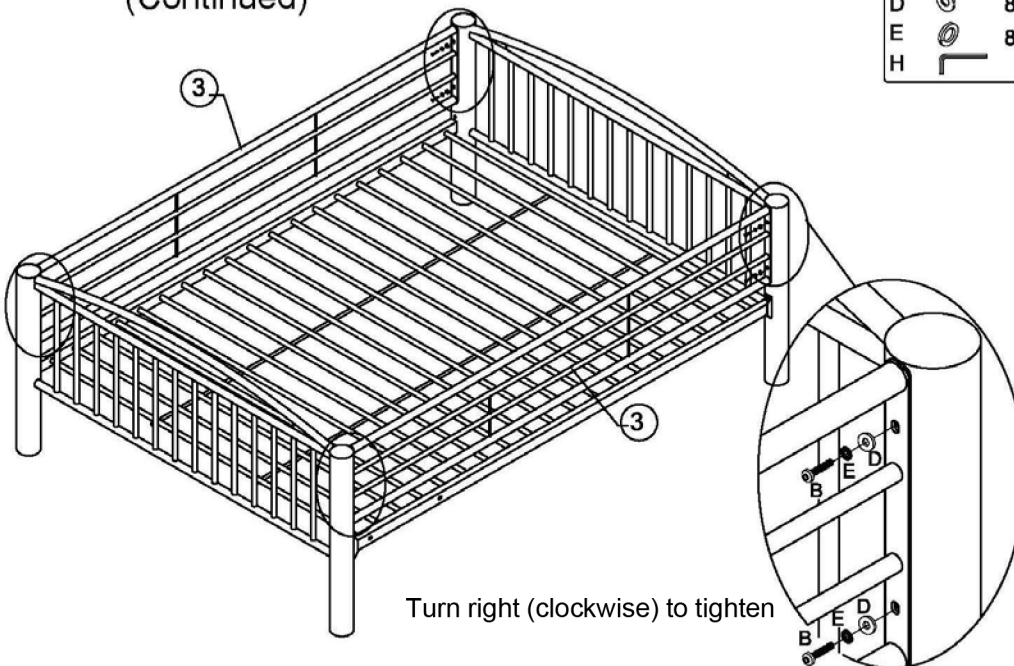

### STEP 2: TOP BUNK ASSEMBLY (Continued)

B		8PCS
D		8PCS
E		8PCS
H		



Turn right (clockwise) to tighten

### STEP 3: BOTTOM BUNK ASSEMBLY

C		8PCS
F		8PCS
G		8PCS
I		

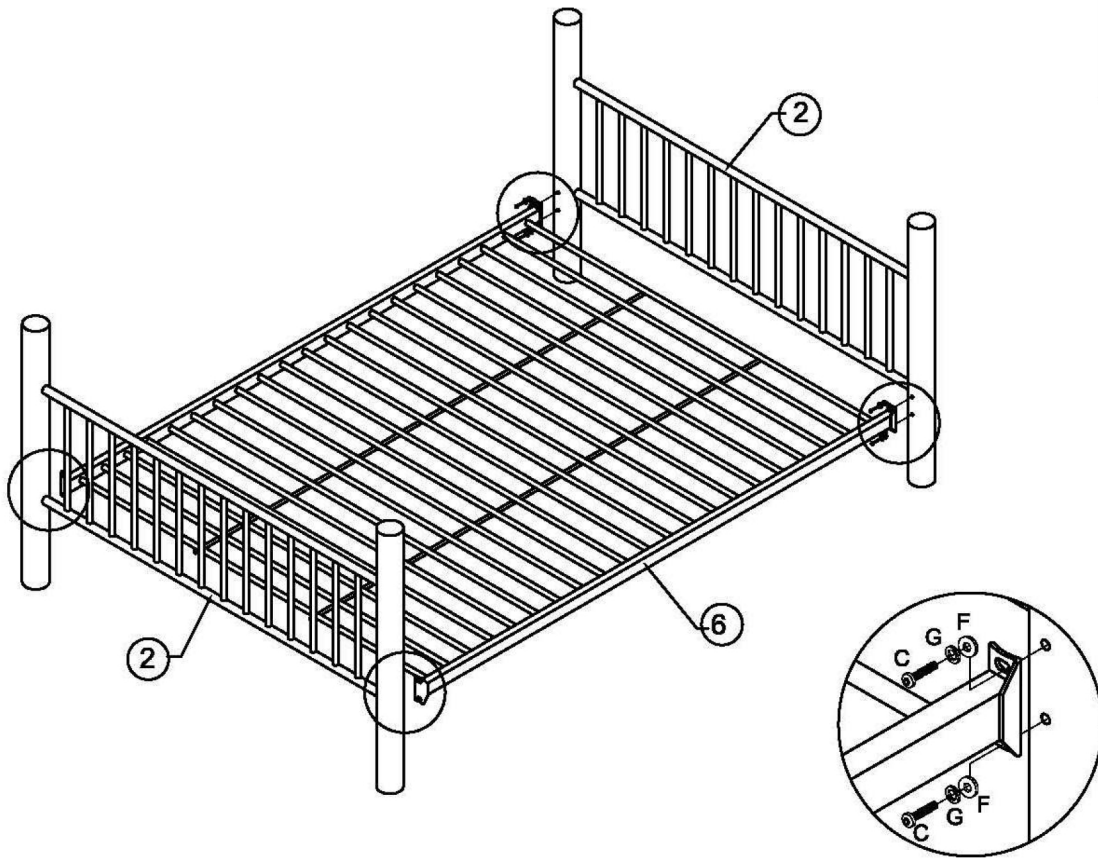

Turn right (clockwise) to tighten



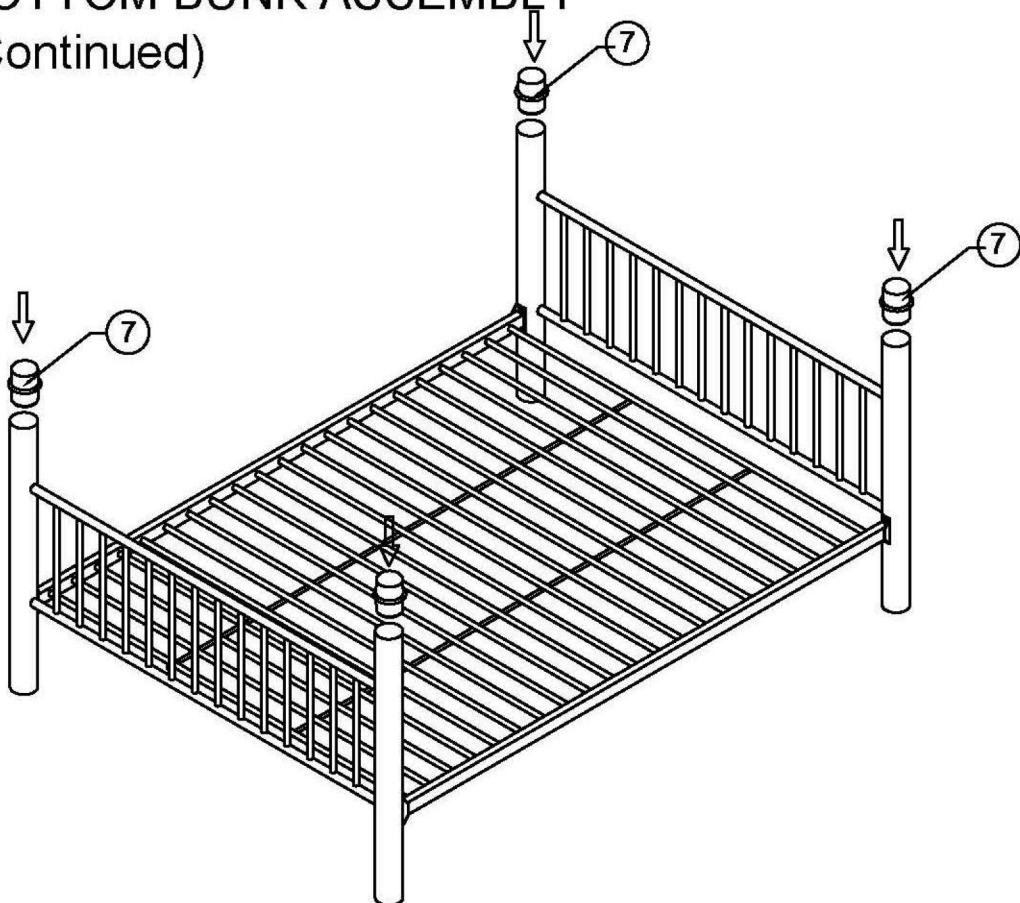

### STEP 4: BOTTOM BUNK ASSEMBLY (Continued)

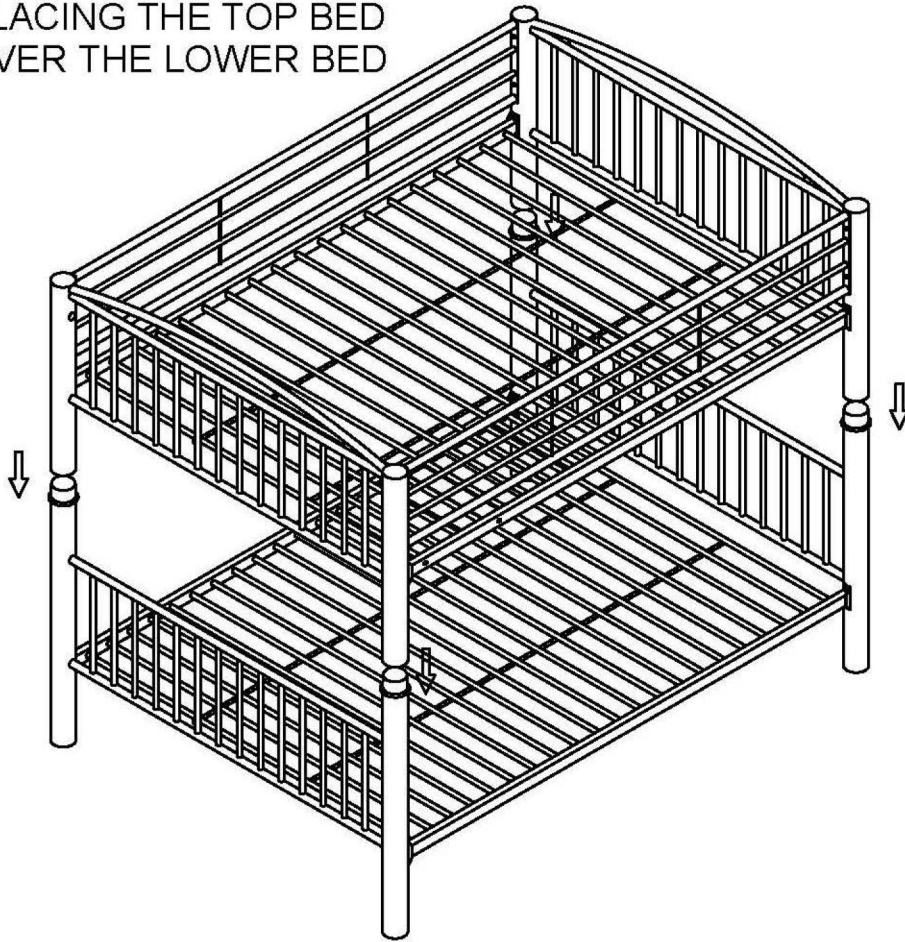

**STEP 5: PLACING THE TOP BED  
OVER THE LOWER BED**



**STEP 6: LADDER ASSEMBLY**

A		2PCS
D		2PCS
E		2PCS
H		

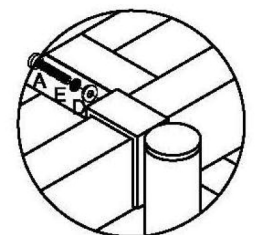
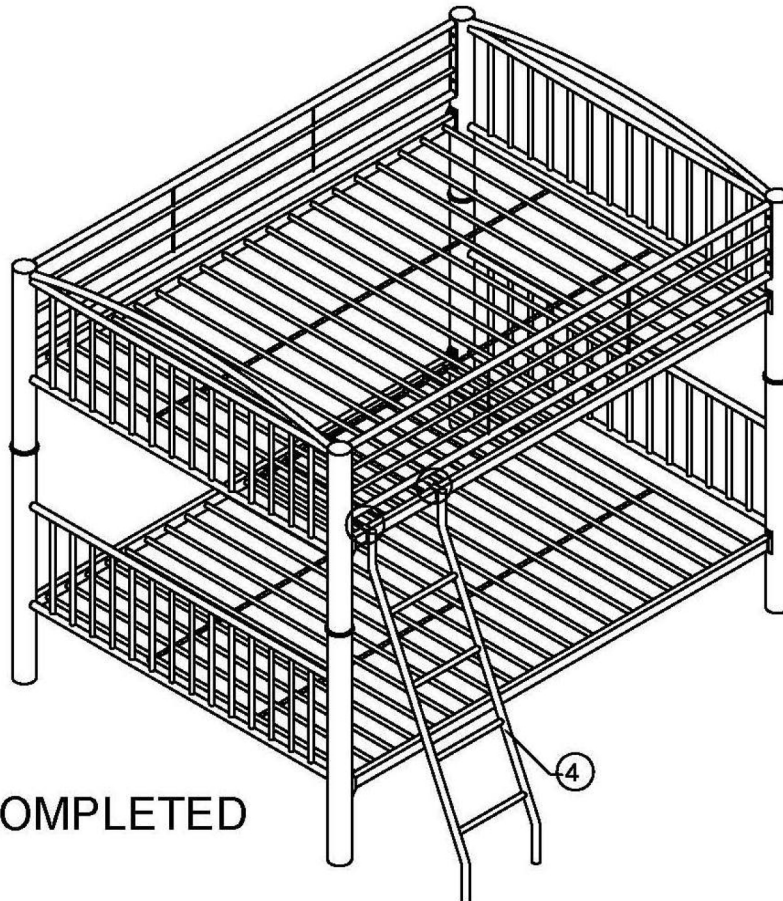

**BUNK BED COMPLETED**

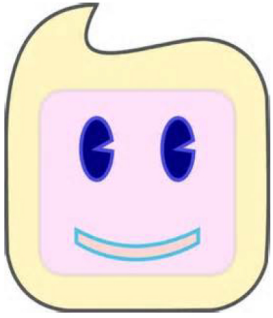

The bunk bed can be converted into two separate full-size beds.

TO REMOVE THE ASSEMBLED BUNK BED FOR USE AS SEPARATE BEDS (AS SHOWN BELOW), PLEASE FOLLOW THE INSTRUCTIONS ON THE FOLLOWING PAGE.

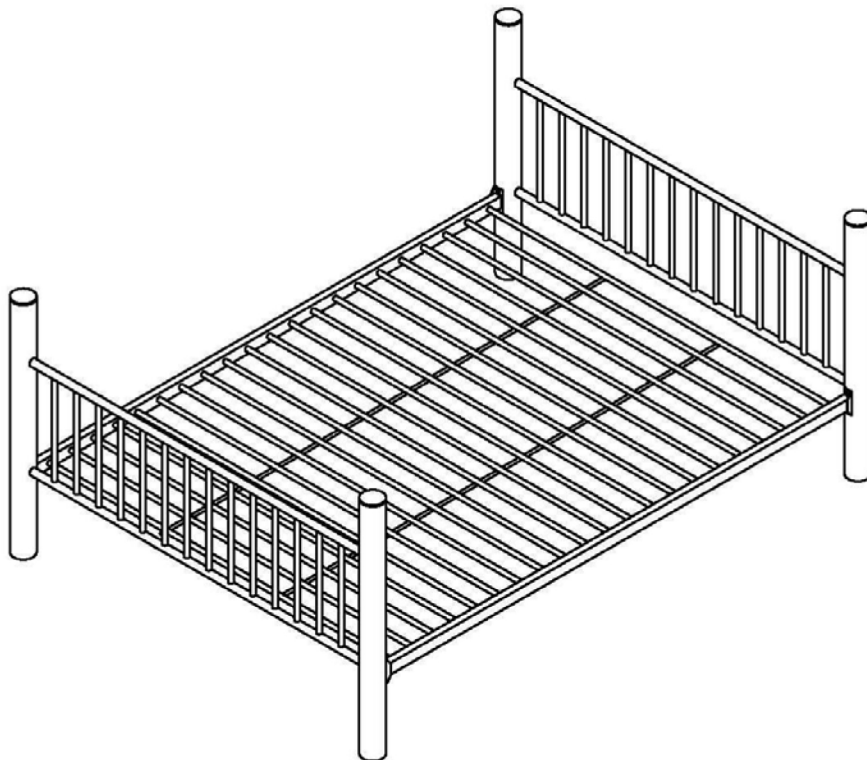
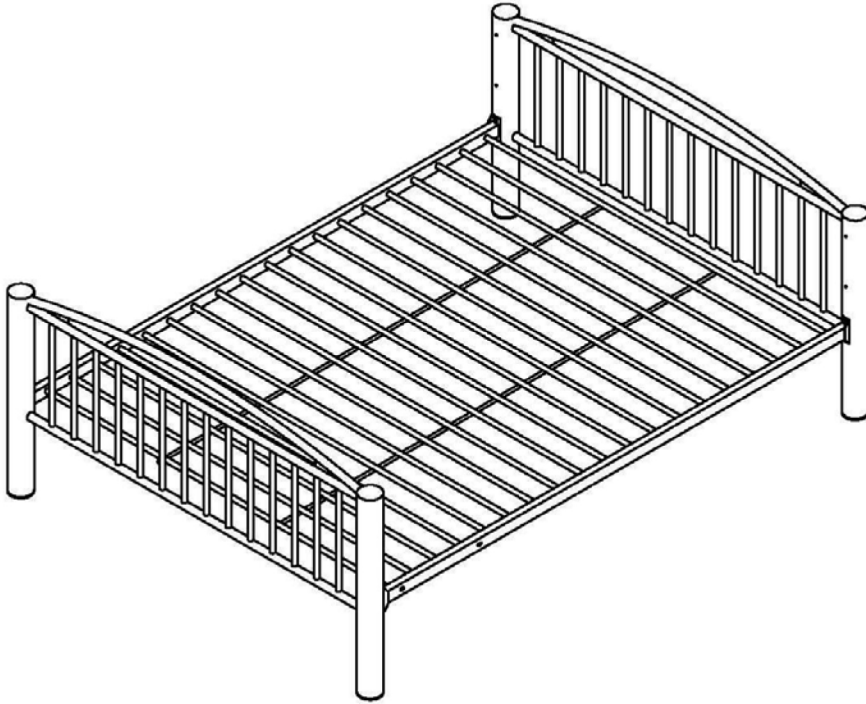

## STEP 1: REMOVE THE GUARDRAILS

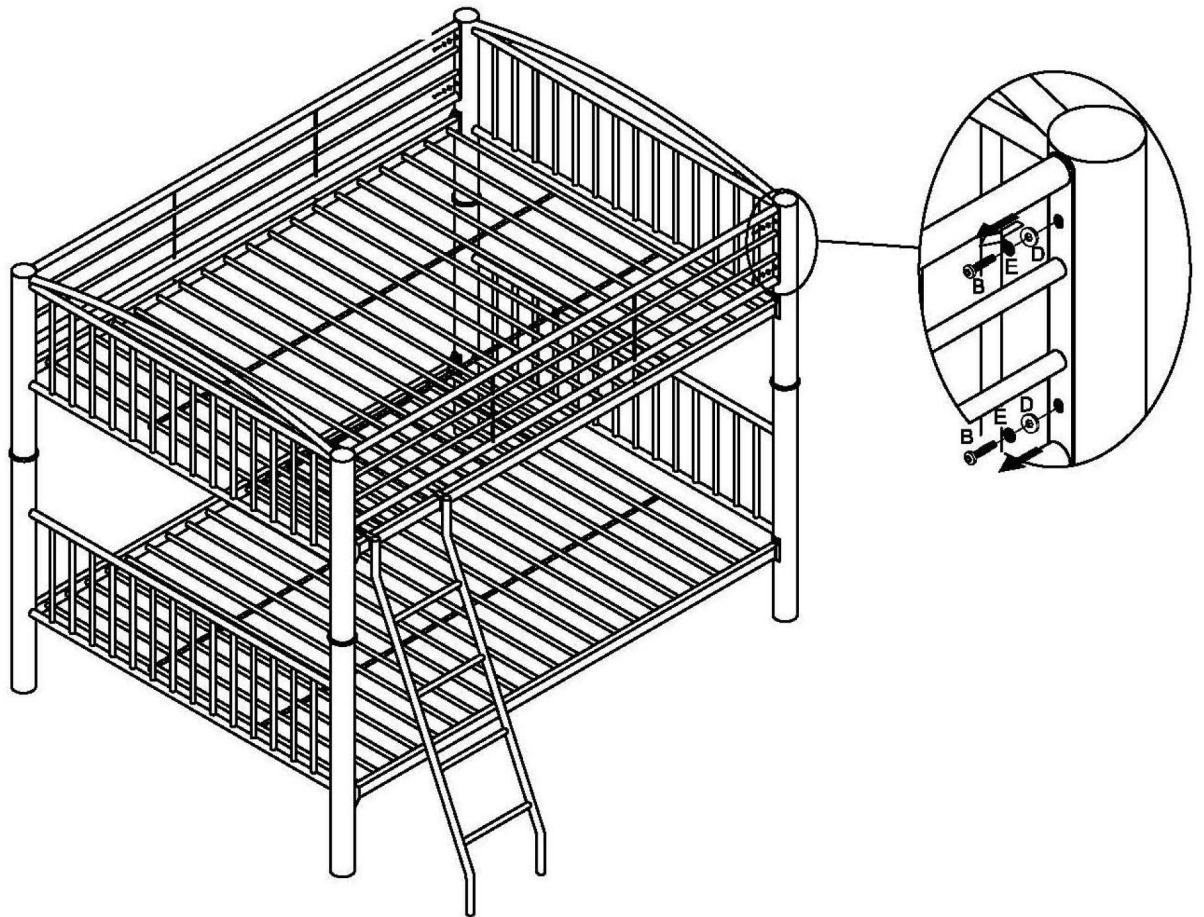

## STEP 2: REMOVE THE LADDER

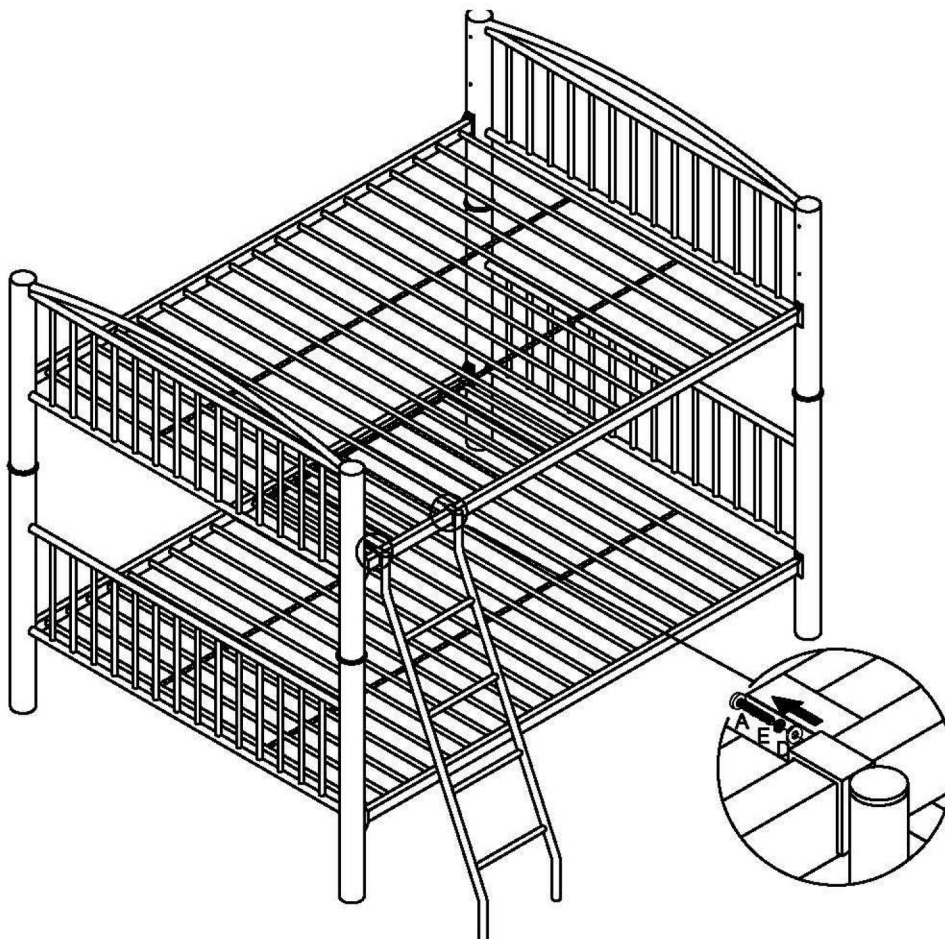

STEP 3: REMOVE THE POST CONNECTORS

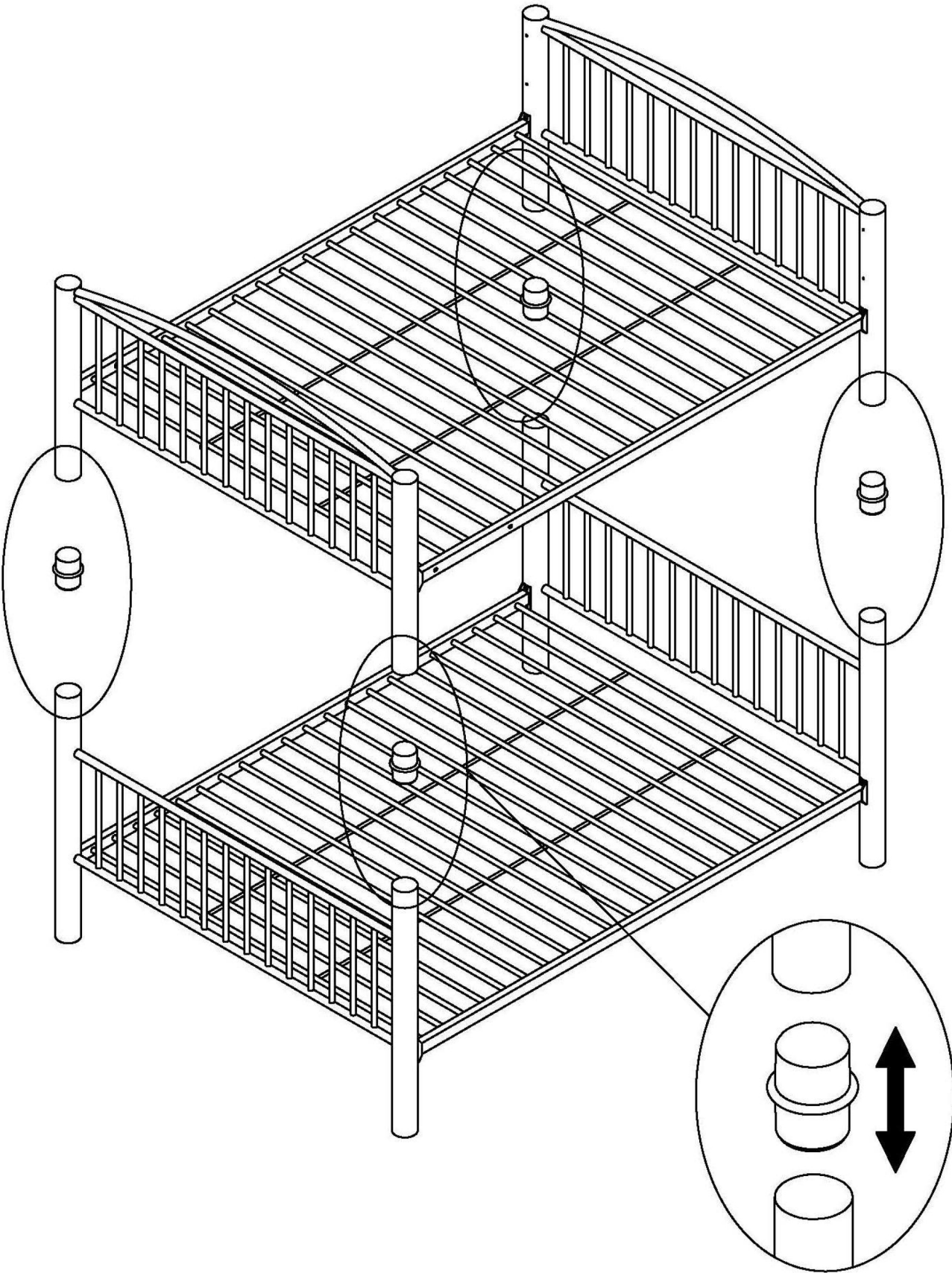

# STEP 4: PLASTIC CAPS ASSEMBLY

J  8PCS

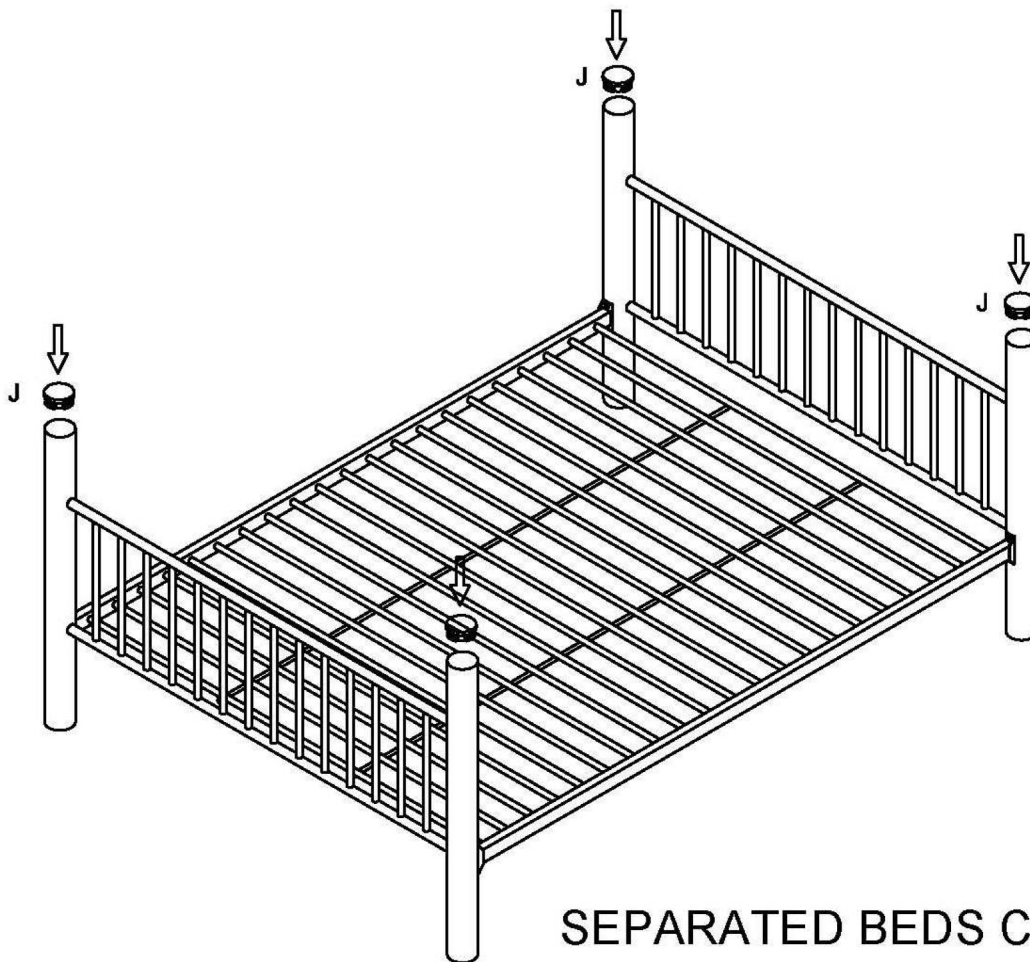
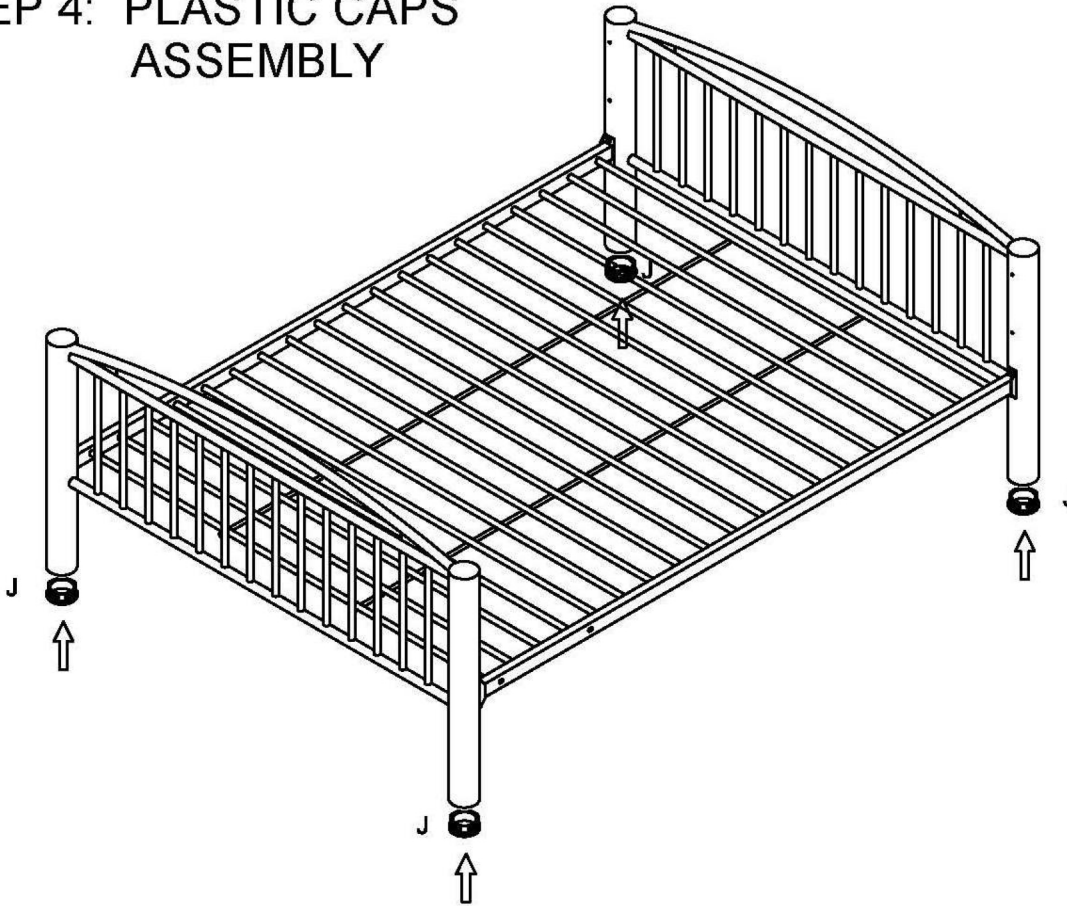

SEPARATED BEDS COMPLETED

## Safety Warnings for Bunk Beds

1. Read and follow the information on the warnings appearing on the bunk bed end structure and on the carton. Do not remove warning label from the bed.
2. Always use the recommended size mattress or mattress support, or both, to help prevent the likelihood of entrapment or falls. Depending on whether you have twin, full or both sizes, the proper mattress size for the UPPER TWIN-SIZE bunk should be 74" to 75" long x 37½" to 38½" wide x 6" high (no higher than 6") OR for the UPPER FULL-SIZE bunk should be 75" long x 54" wide x 6" high (no higher than 6"). The proper mattress size for the LOWER TWIN-SIZE bunk should be 74" to 75" long x 37½" to 38½" wide x 6" to 8" high OR for the LOWER FULL-SIZE bunk should be 75" long x 54" wide x 6" to 8" high.
3. Surface of mattress must be at least 5 inches (127 mm) below the upper edge of guardrails.
4. Do not allow persons under 6 years of age to use the upper bunk.
5. Periodically check and ensure that the guardrails, ladder, handle and other components are in their proper position, free from damage, and that all connectors are tighten and secured.
6. For safety reasons, especially on the upper bunk bed, DO NOT allow rough playing or jumping on the bed and do not allow playing or hiding under the bed.
7. Always use the ladder for entering and leaving the upper bunk.
8. Do not use substitute parts. Contact the manufacturer or dealer for replacement parts.
9. Use of a nightlight may provide added safety precaution for a person using the upper bunk.
10. Always use the guardrails on both long sides of the upper bunk. If the bunk bed will be placed next to the wall, the guardrail that runs the full length of the bed should be placed against the wall to prevent entrapment between the bed and the wall.
11. The use of water or sleep flotation mattresses is prohibited.
12. No more than one person is allowed on the upper bunk at all times.
13. The MAXIMUM weight capacity for the upper bunk is not to exceed 150 lbs.
14. Keep these instructions for future reference.



## **WARNING: STRANGULATION HAZARD**

Never attach or hang objects to any part of the bunk bed that are not designed for use with the bed. Objects such as hanger, hook, belt, bag, rope, string, etc. should not be used on or around the bunk bed.