

Assembly Instructions

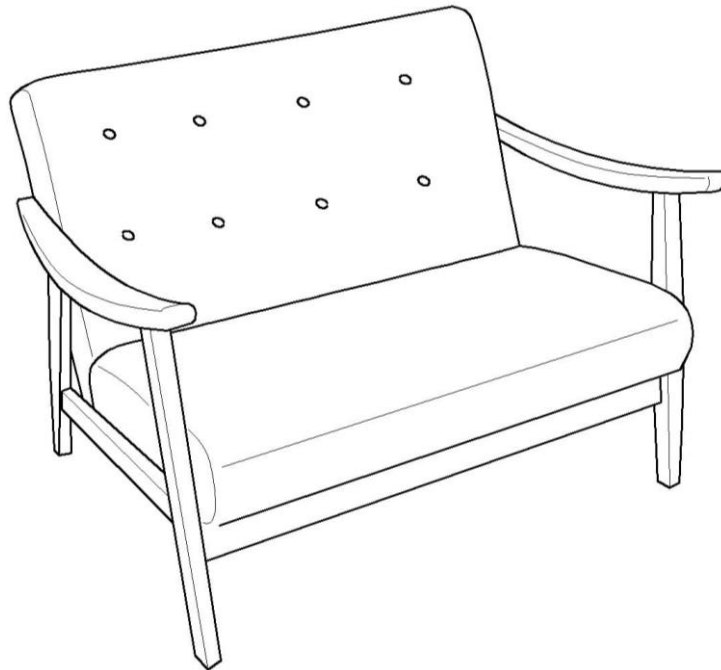

Caution: You must read this before you proceed

Sofa



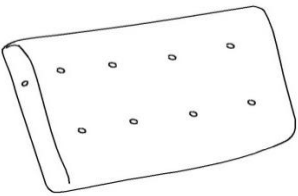

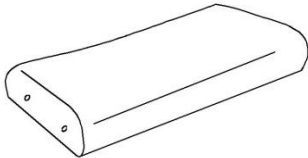

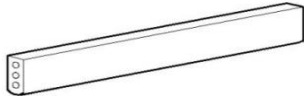

Part List

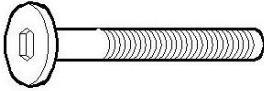
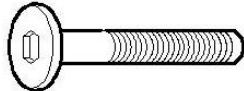
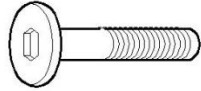
Label	Picture	Description	QTY
A		Sofa Back	1

B		Sofa Seat	1
C		Left Leg	1
D		Right Leg	1
E		Lower Apron	1

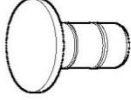
Hardware

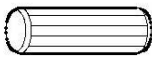
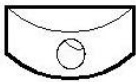
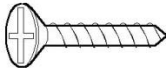
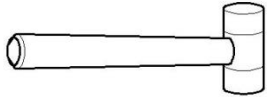
Label	Picture	Description	QTY
①		Bolt (M6x70mm)	3
②		Bolt (M6x50mm)	5
③		Bolt (M6x40mm)	7

④		Spring Washer	13
⑤		Washer	11
⑥		PVC Nail Leg	5
⑦		Allen Key	1
⑧		Wood Dowel (M8x30mm)	5
⑨		Half Moon Washer	3
⑩		Screw (M4x32mm)	2
⑪		Rubber Hammer (Not Provided)	1
⑫		Screwdriver (Not Provided)	1

Assembly Preparation

Before
Beginning
Assembly:

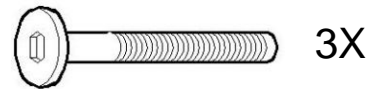
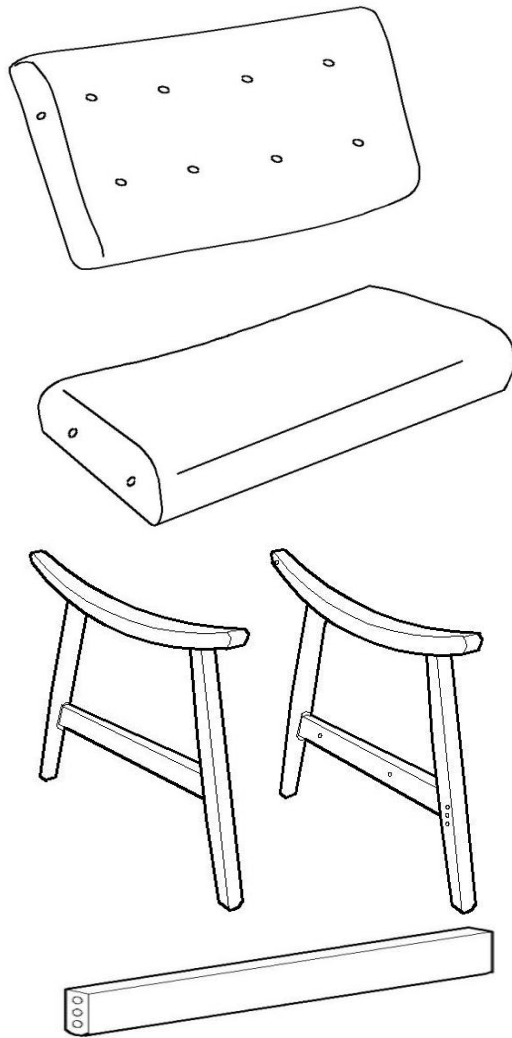

3X

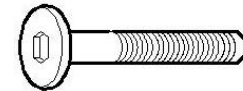

5X

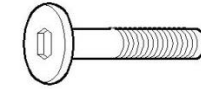

7X



13X



11X

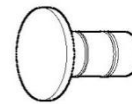

5X



1X

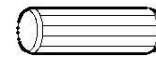

5X

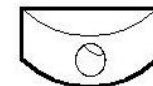

3X

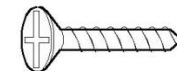

2X

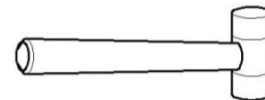

1X

(Not Provided)



1X

(Not Provided)



• Read instructions, cover to cover-



• Have 2 adults on hand for assembly-



• Do not assemble on flooring or carpet-



• Assemble on a clean non-marring surface (packing foam)-



• Save all packaging until finished-

Assembly Steps

Overview

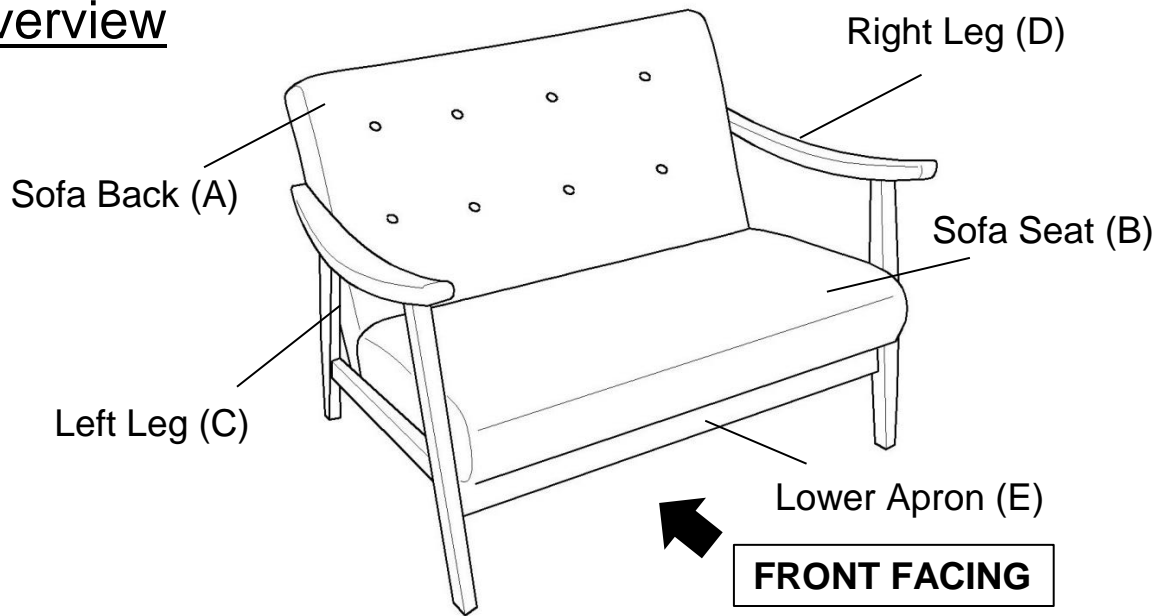

This Sofa has multiple parts and may require up to 30 minutes to assemble. To give you an overview of the Sofa parts, the above picture is to help you put the various parts into perspective. Please read through the instructions below to familiarise yourself with the parts and steps before assembly.

Step 1

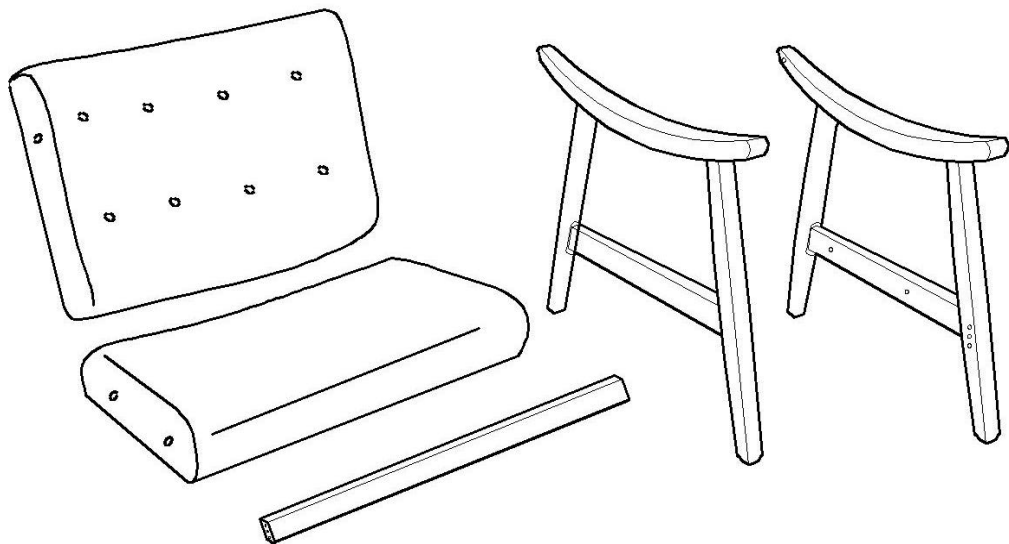

Unpack and place all parts on a clean, non-marring surface.

Step 2

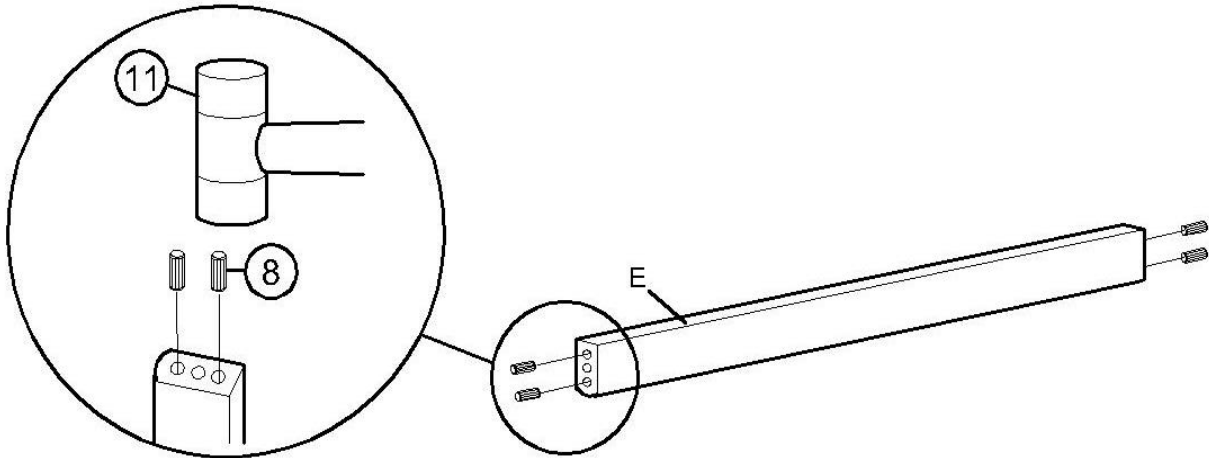

Insert Wood Dowels(⑧) into Lower Apron(E) using the Rubber Hammer(⑪).

Step 3

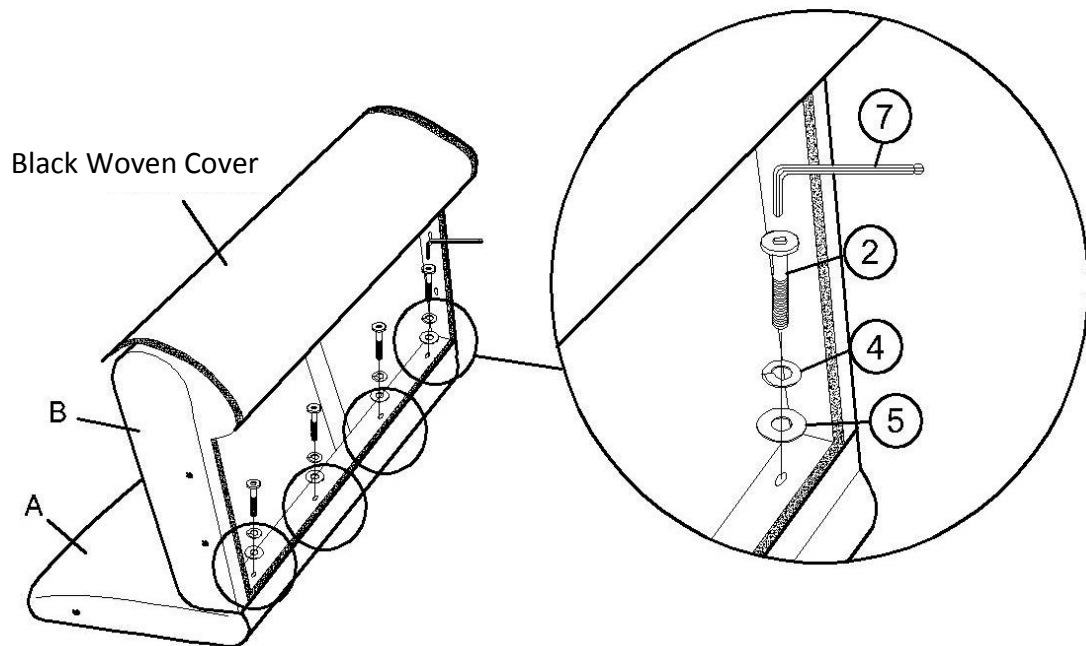

Place the Sofa Back(A) onto a clean, non-marring surface.

Open the black woven cover under the Sofa Seat(B).

Attach Sofa Seat(B) to Sofa Back(A) using Bolts(②), Spring Washers(④), and Washers(⑤) with Allen Key(⑦).

Do not fully tighten the Bolts.

Step 4

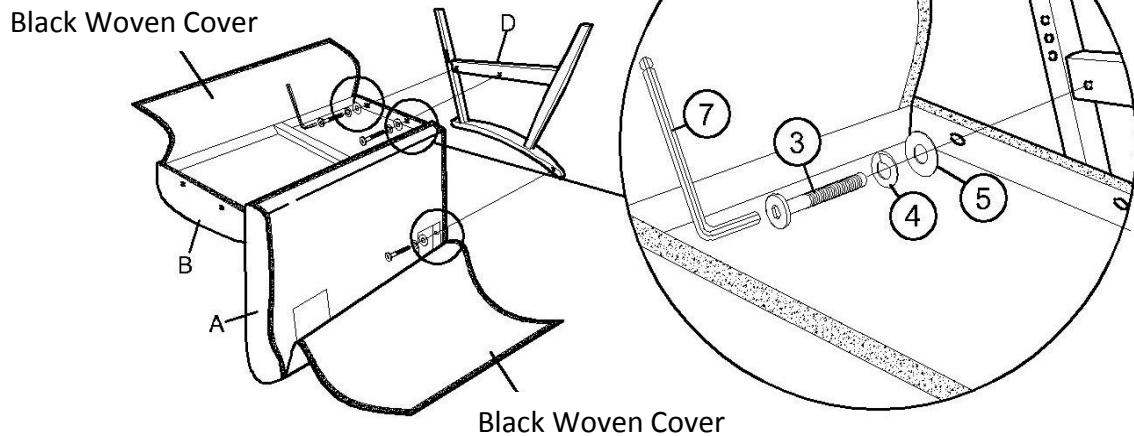

Place Right Leg(D) facedown on a clean, non-marring surface.
Open the black woven cover on the Sofa Back(A).
Attach Sofa Back(A) and Sofa Seat(B) to Left Leg(D) using Bolts(③), Spring Washers(④), and Washers(⑤) with Allen Key(⑦).
Do not fully tighten the Bolts.

Step 5

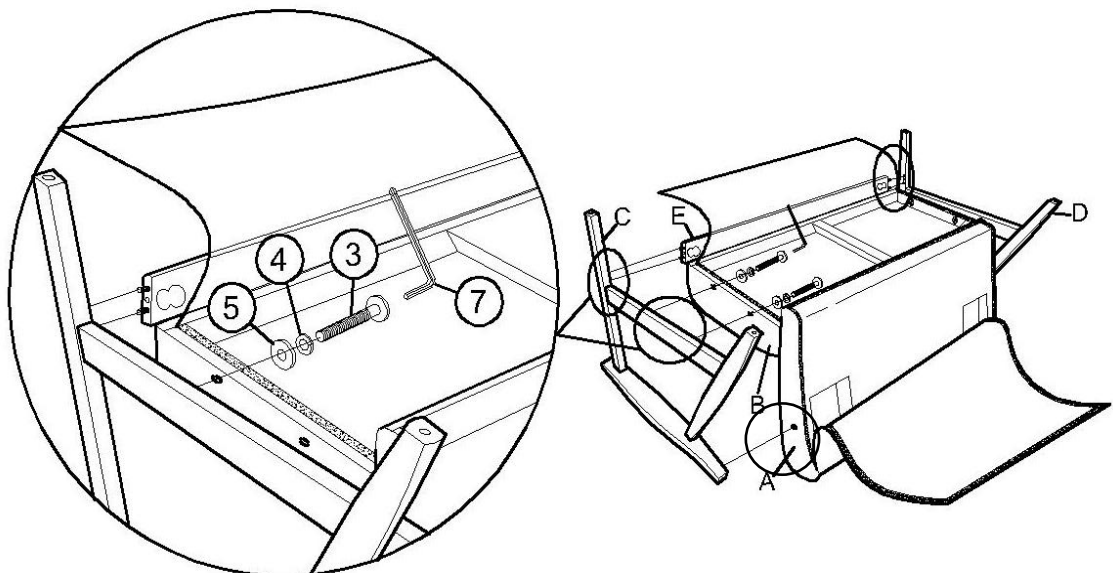

Attach Sofa Back(A) and Sofa Seat(B) to Left Leg(C) using Bolts(③), Spring Washers(④), and Washers(⑤) with Allen Key(⑦).
Do not fully tighten the Bolts.

Step 6

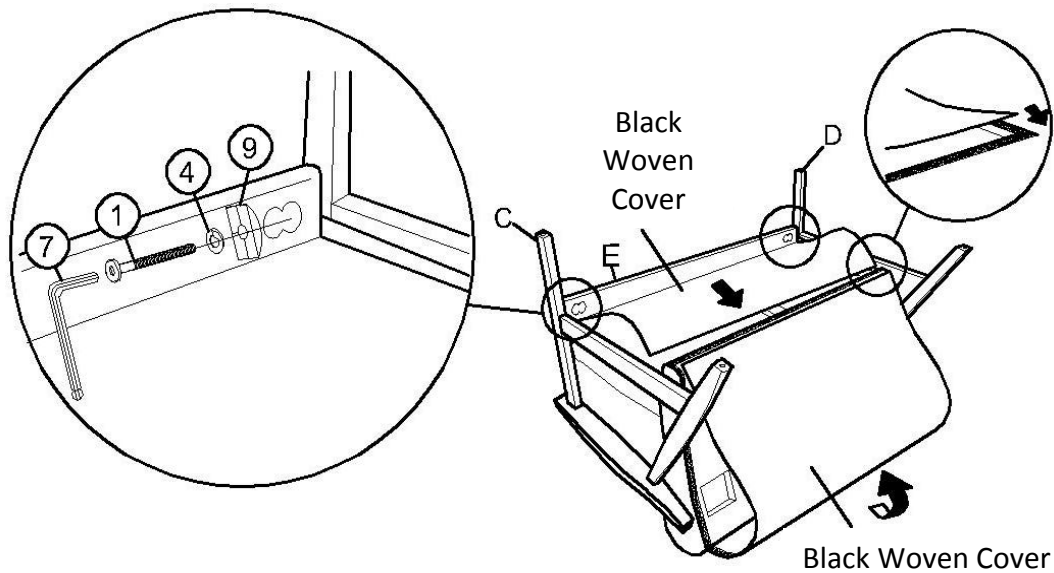

Close the black woven cover of the Sofa Seat(B).
Insert the Lower Apron(E) into the Left Leg(C) and Right Leg(D) as pictured.
Attach Lower Apron(E) into the Left Leg(C) and Right Leg(D) using Bolts(①),
Spring Washers(④), and Half Moon Washer(⑨) with Allen Key(⑦).
Do not fully tighten the Bolts.

Step 7

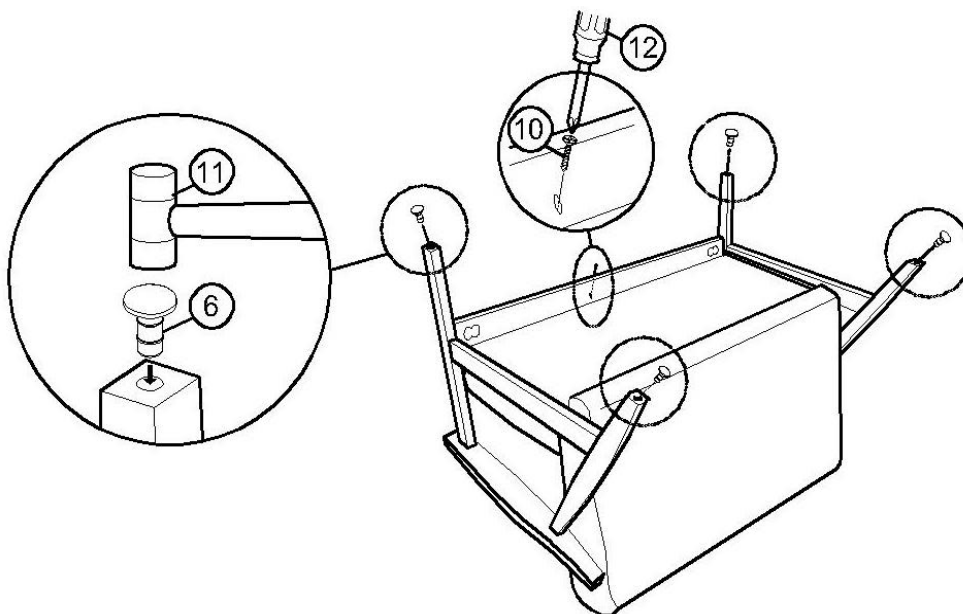

Attach Lower Apron(E) to Sofa Seat(B) using Screw(⑩) with Screwdriver(⑫).
Attach PVC Nail Legs(⑥) into the bottom of Sofa Legs with Rubber
Hammer(⑪).

Step 8

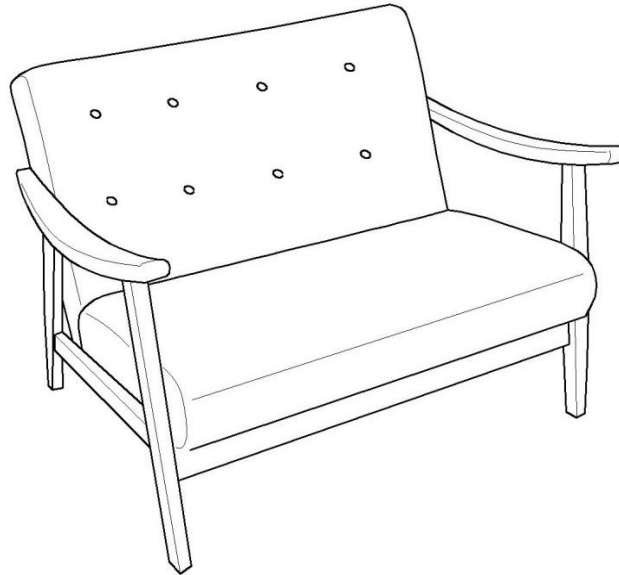

Place the Sofa on a LEVEL SURFACE.

Gently and carefully sit into the Sofa.

This will help to align all Parts and Bolts fully.

Test the Sofa for wobbles.

If no wobbles are found then proceed to tighten all Bolts in a sequential manner.

Do not tighten any Bolt fully and then move on towards the next one, this could cause the frame to warp.





















Inspect it and make sure all parts are adequately connected.

Close the black woven covers on Sofa Seat(B) and Sofa Back(A).

Your Sofa is ready for use.

This Sofa can only be used on a flat, level surface.

Care & Maintenance

-   ● Do not put hot items directly on furniture surface
 -   ● Do not clean furniture with harsh cleansers or polish.
 -   ● Do not place furniture under direct sunlight.
 -   ● Do not place furniture near heating or cooling vents.
 -   ● Do not write on furniture without a padded barrier to protect the surface.
 -   ● Do not place furniture outside . For indoor use only .
 -   ● Not for commercial use. For residential use only .
 -   ● Stains may be removed with mild soap solution and damp cloth.
 -   ● Children should not climb or jump on the furniture.
-
-   ● Dust and pick-up spills using a clean, non-colored, lint-free cloth .

Questions & Answers about Proposition 65

• What is Proposition 65?

Proposition 65 requires businesses to provide warnings to Californians about significant exposures to chemicals that cause cancer, birth defects or other reproductive harm. These chemicals can be in the products that Californians purchase, in their homes or workplaces, or that are released into the environment. By requiring that this information be provided, Proposition 65 enables Californians to make informed decisions about their exposures to these chemicals.

Proposition 65 also prohibits California businesses from knowingly discharging significant amounts of listed chemicals into sources of drinking water.

Proposition 65 requires California to publish a list of chemicals known to cause cancer, birth defects or other reproductive harm. This list, which must be updated at least once a year, has grown to include approximately 900 chemicals since it was first published in 1987.

• What types of chemicals are on the Proposition 65 list?

The list contains a wide range of naturally occurring and synthetic chemicals that include additives or ingredients in pesticides, common household products, food, drugs, dyes, or solvents. Listed chemicals may also be used in manufacturing and construction, or they may be byproducts of chemical processes, such as motor vehicle exhaust.

• What does a warning mean?

If a warning is placed on a product label or posted or distributed at a workplace, a business, or in rental housing, the business issuing the warning is aware or believes that it is exposing individuals to one or more listed chemicals.

By law, a warning must be given for listed chemicals unless the exposure is low enough to pose no significant risk of cancer or is significantly below levels observed to cause birth defects or other reproductive harm.

• Where can I get more information on Proposition 65?

If you have specific questions on the administration or implementation of Proposition 65, you can contact OEHHA's Proposition 65 program at P65.Questions@oehha.ca.gov, or by phone at (916) 445-6900.