

SECTIONAL SOFA

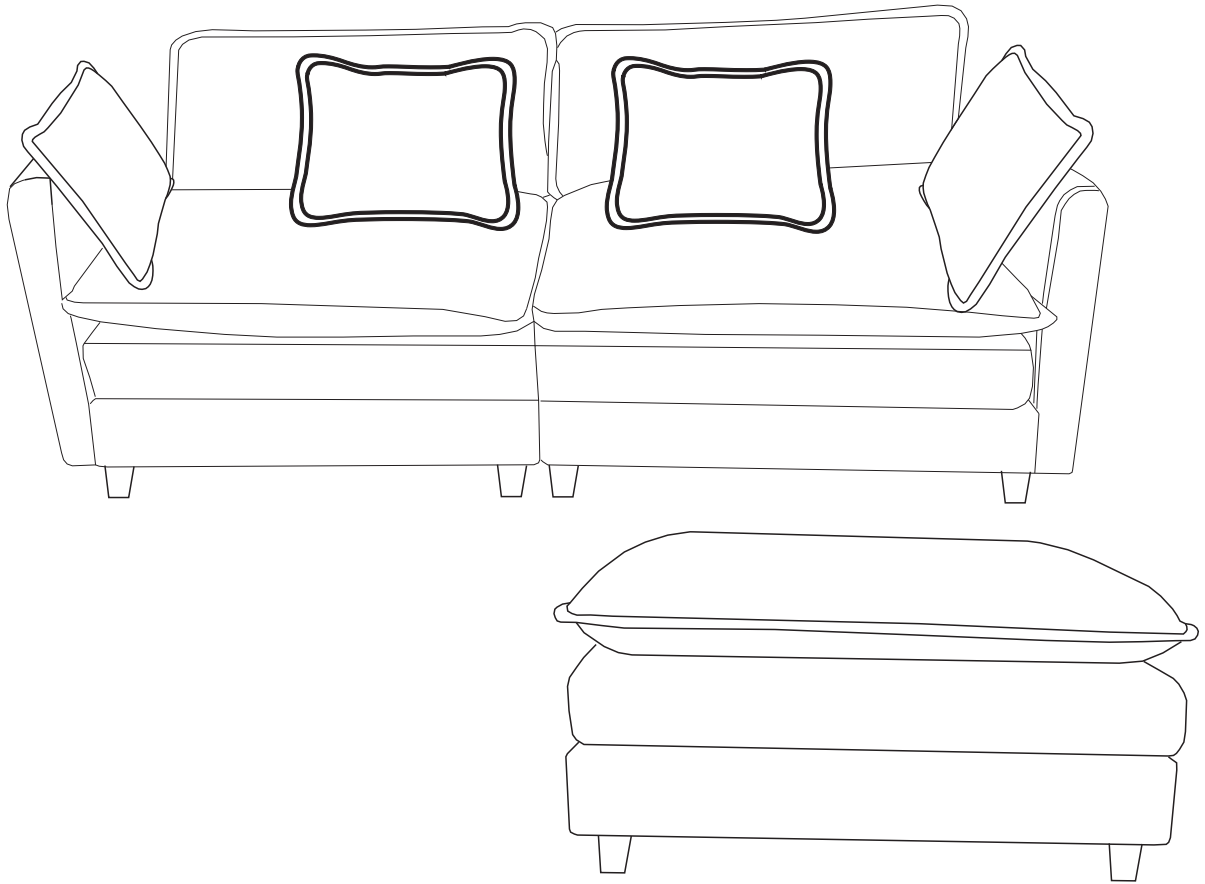

Thank you for purchasing our products.

To ensure safe and satisfactory use of this product, please read the following instructions carefully before assembly.

1. Please check if you have already received two boxes. After unpacking, please check if all of the accessories in the corresponding box are complete first.











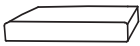

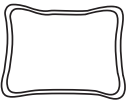

2. Our cushions are vacuum packed for convenient shipping. Please allow 2-3 days for them to fully expand to their original shape and for any wrinkles to disappear.

3. If there is any part missing or damaged, please kindly send message with the detailed part name regarding this instruction to us, we will send replacement for you asap.









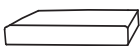

Note: Please retain all boxes until you are certain that the product isn't damaged.

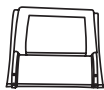
PART LIST & HARDWARE

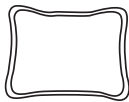
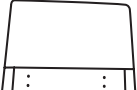
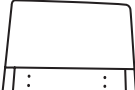
BOX A

<p>A Seat frame</p>  <p>1PC</p>	<p>B Seat cushion</p>  <p>1PC</p>	<p>C Back Cushion</p>  <p>1PC</p>	<p>J Ottoman frame</p>  <p>1PC</p>	<p>K Ottoman cushion</p>  <p>1PC</p>
<p>F Backrest</p>  <p>1PC</p>	<p>D Pillow</p>  <p>2PCS</p>	<p>G Leg</p>  <p>8PCS</p>	<p>L Gasket</p>  <p>8PCS</p>	<p>N Washer</p>  <p>13PCS</p>
<p>O M8*60mm Bolt</p>  <p>4PCS</p>	<p>P M8*80mm Bolt</p>  <p>4PCS</p>	<p>Q Butterfly Nut</p>  <p>4PCS</p>	<p>R Alley Key</p>  <p>1PC</p>	

BOX B

<p>A Seat frame</p>  <p>1PC</p>	<p>B Seat cushion</p>  <p>1PC</p>	<p>C Back Cushion</p>  <p>1PC</p>	<p>F Backrest</p>  <p>1PC</p>	<p>G Leg</p>  <p>4PCS</p>
<p>D Pillow</p>  <p>2PCS</p>	<p>H Left armrest</p>  <p>1PC</p>	<p>I Right armrest</p>  <p>1PC</p>	<p>L Gasket</p>  <p>8PCS</p>	<p>N Washer</p>  <p>21PCS</p>
<p>O M8*60mm Bolt</p>  <p>12PCS</p>	<p>P M8*80mm Bolt</p>  <p>4PCS</p>	<p>Q Butterfly Nut</p>  <p>4PCS</p>	<p>R Alley Key</p>  <p>2PCS</p>	

ASSEMBLY STEPS

STEP 1: Assemble the Legs (G) on the sofa with Gaskets (L).

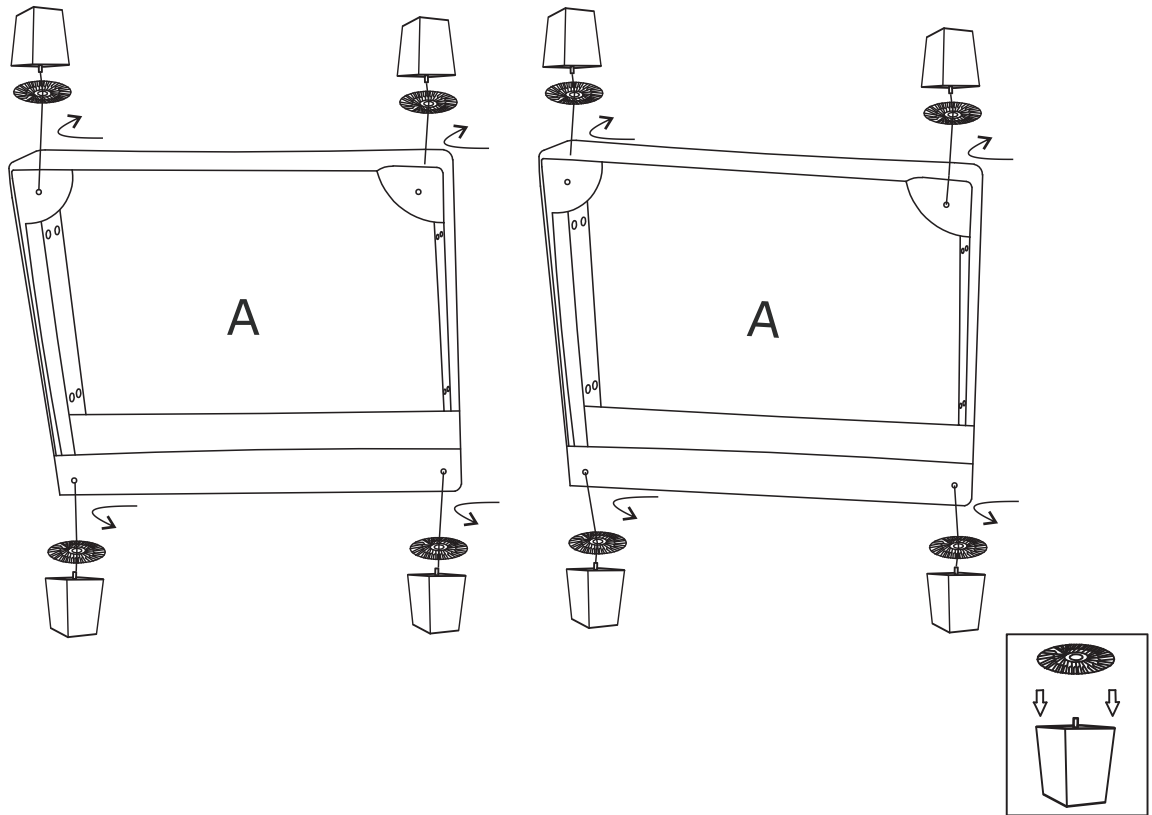

STEP 2: Assemble the Left armrest (H) to the Seat frame (A) with Washers (N) and Bolts (O).

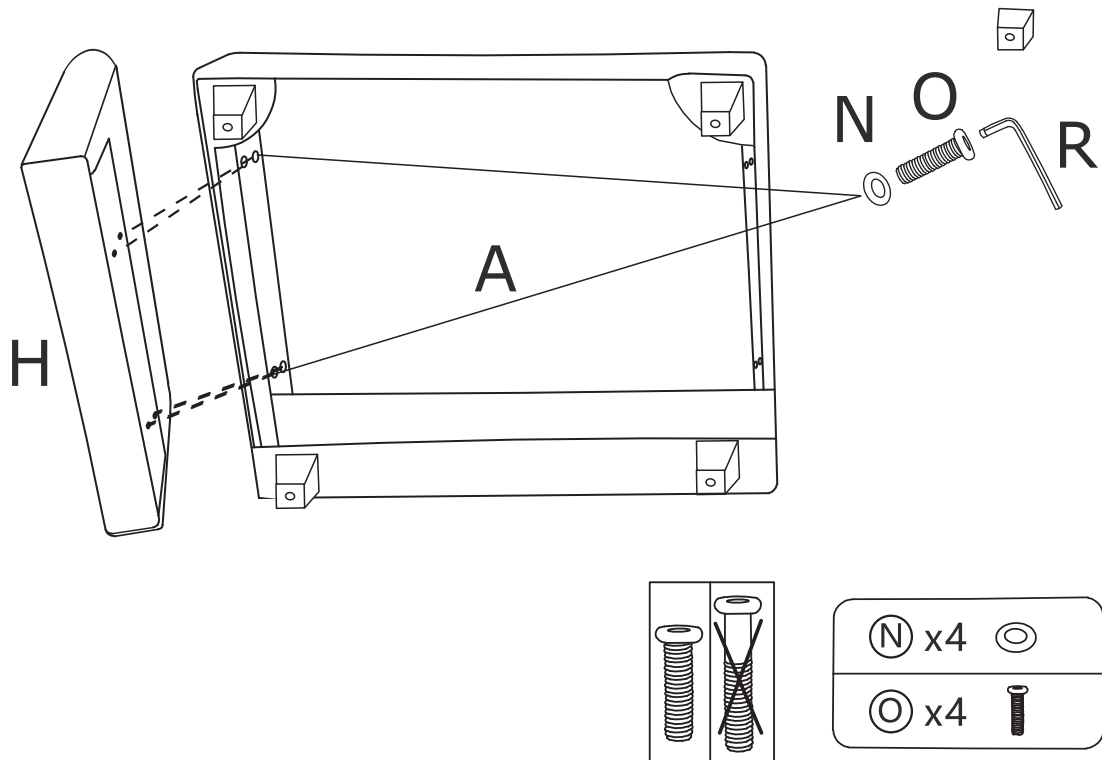

STEP 3: Assemble the Right armrest (I) to the Seat frame (A) with Washers (N) and Bolts (O).

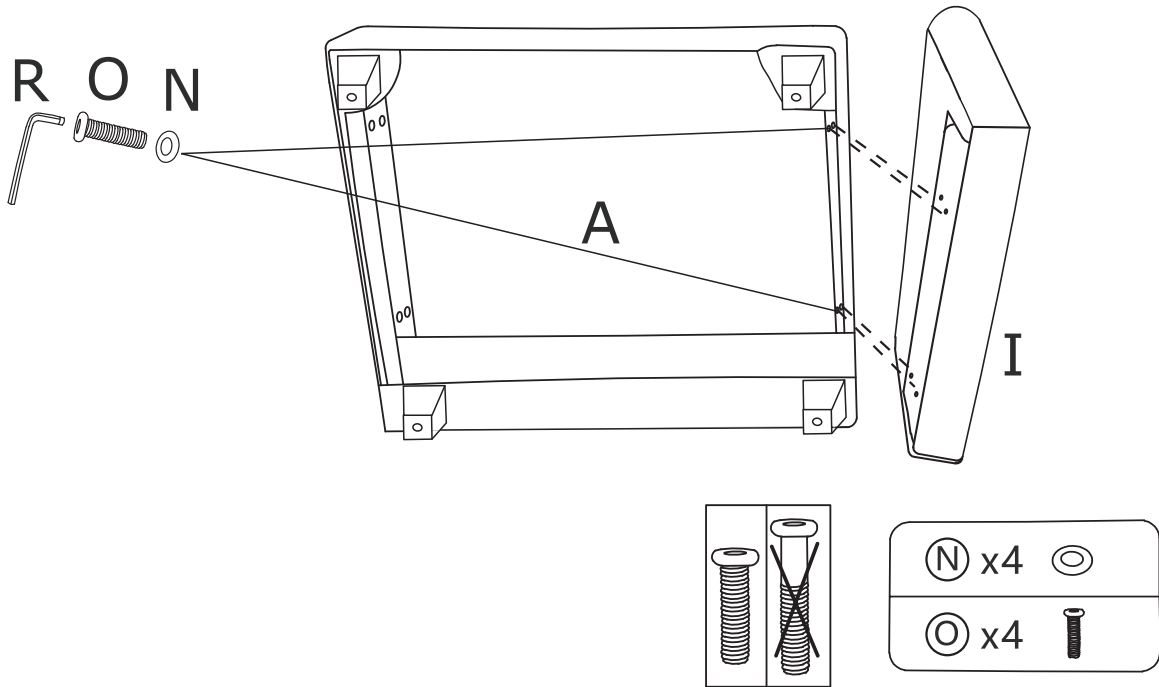

STEP 4: Assemble Seat frame (A) and Seat frame (A) with Butterfly nuts (Q) Washers (N) and Bolts (P).

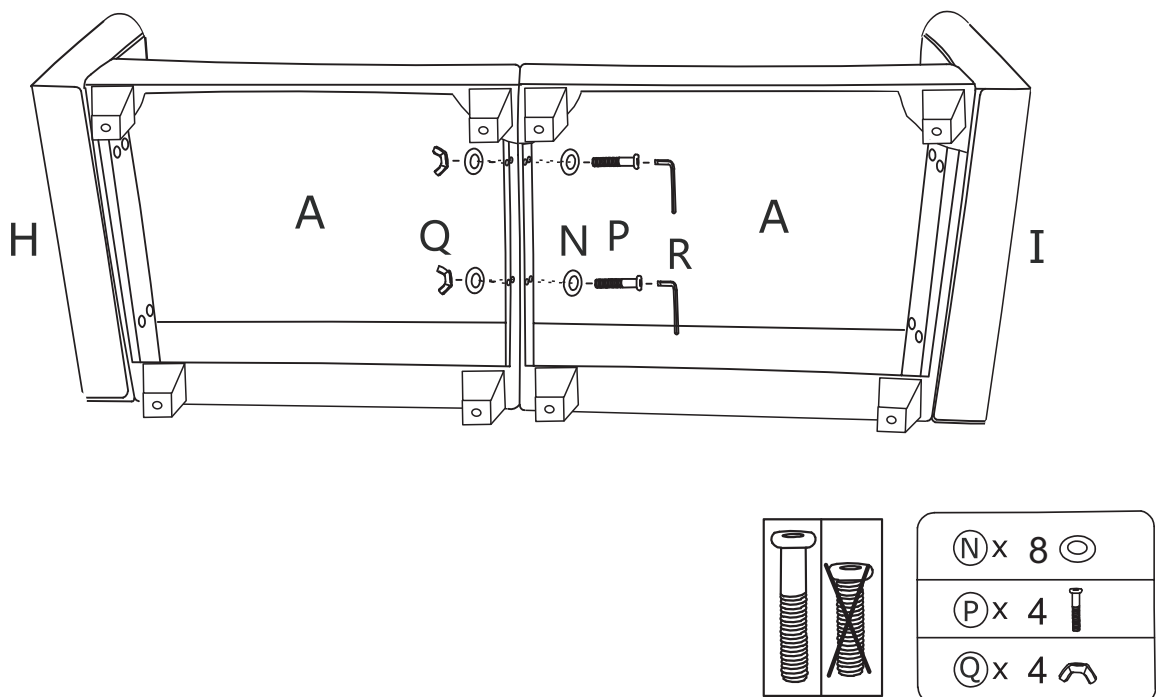

STEP 5: Assemble the Legs (G) on the ottoman frame with Gaskets (L) .

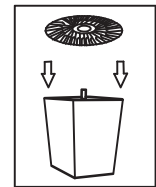
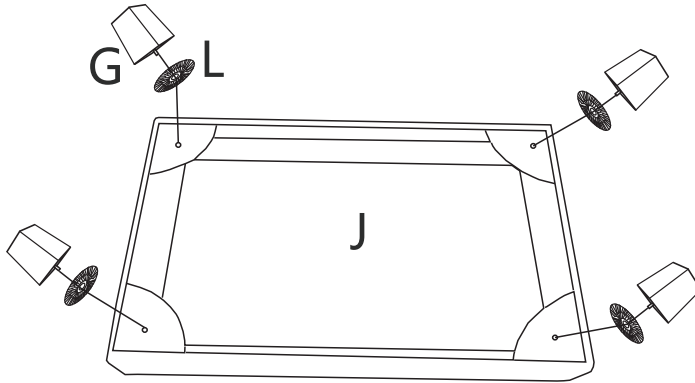

STEP 6: Insert the Backrest (F) into the designated holes, using Washer (N) and Bolts (O) to 70% tightness, and then tighten the all Bolts on the seat.

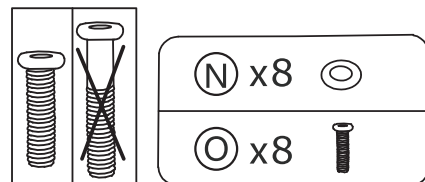
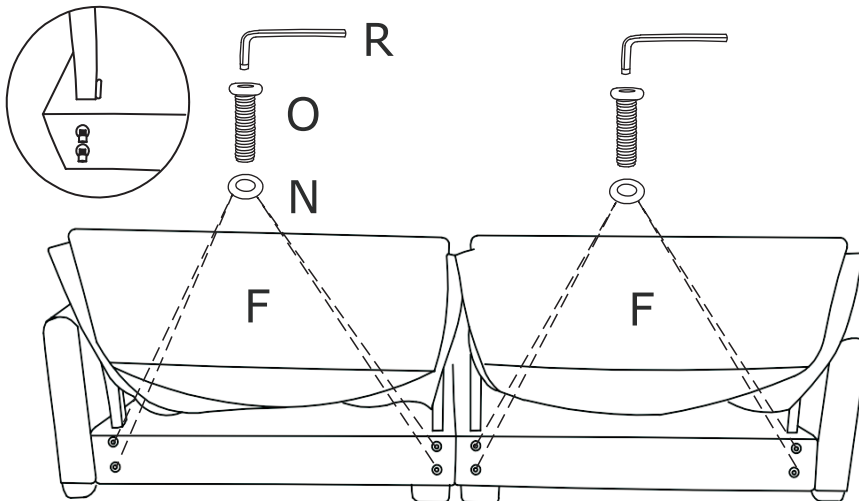

STEP 7: The cushions is packaged by vacuum compression. After cutting the package, it rebounds quickly within 4 hours. If the fabric has wrinkles, it will basically disappear after standing for 72 hours

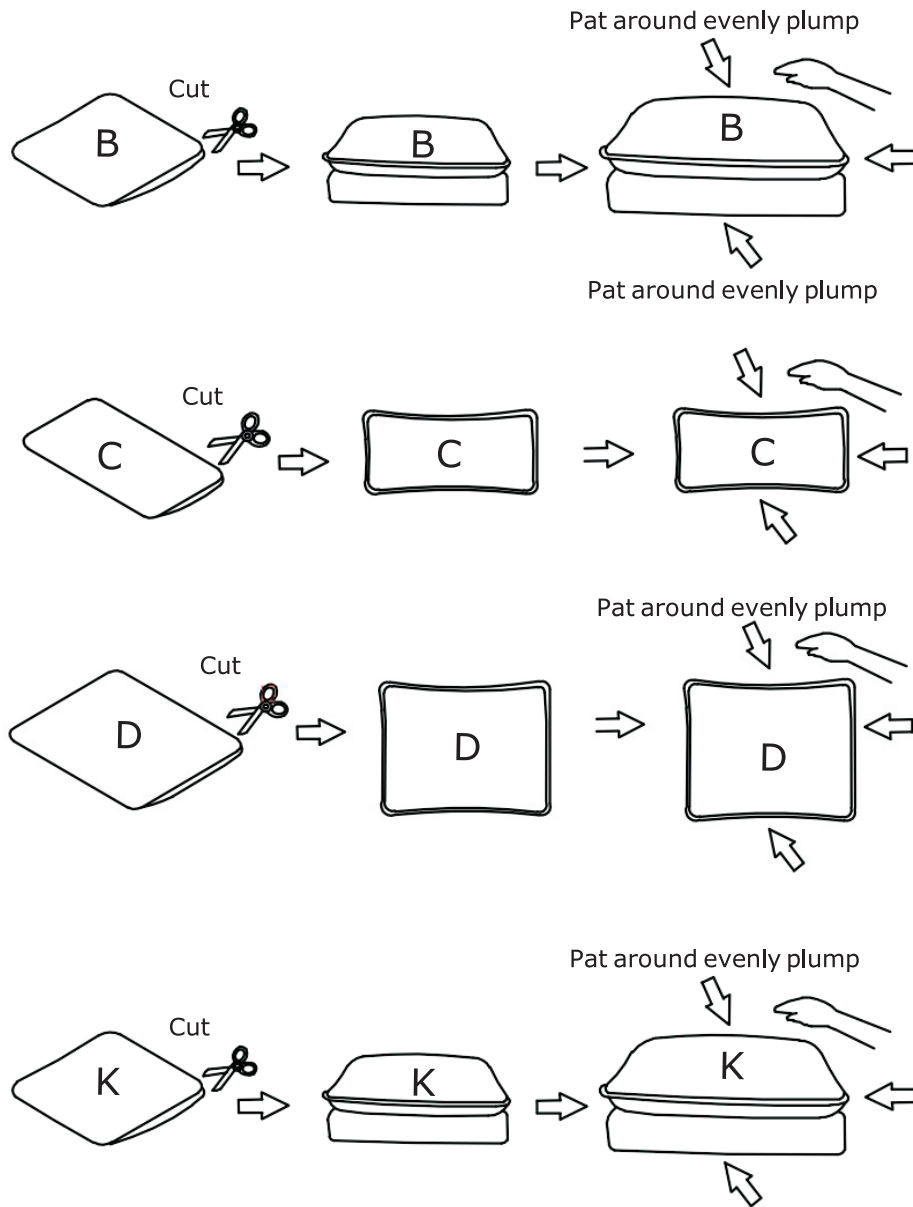

STEP 8: Place Seat Cushions (B) and Back Cushions (C) and Pillow (D) , and make sure it's will fitted.

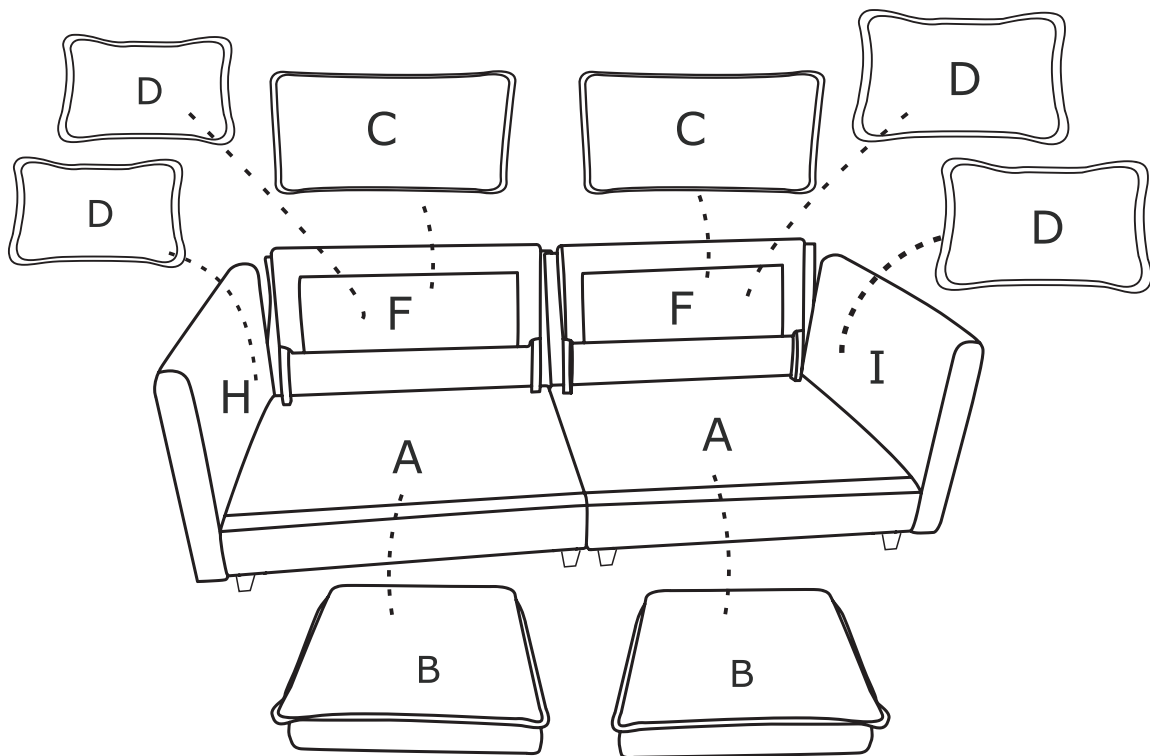

STEP 9: Place seat Ottoman cushion (K) on the Ottoman frame (J).

