

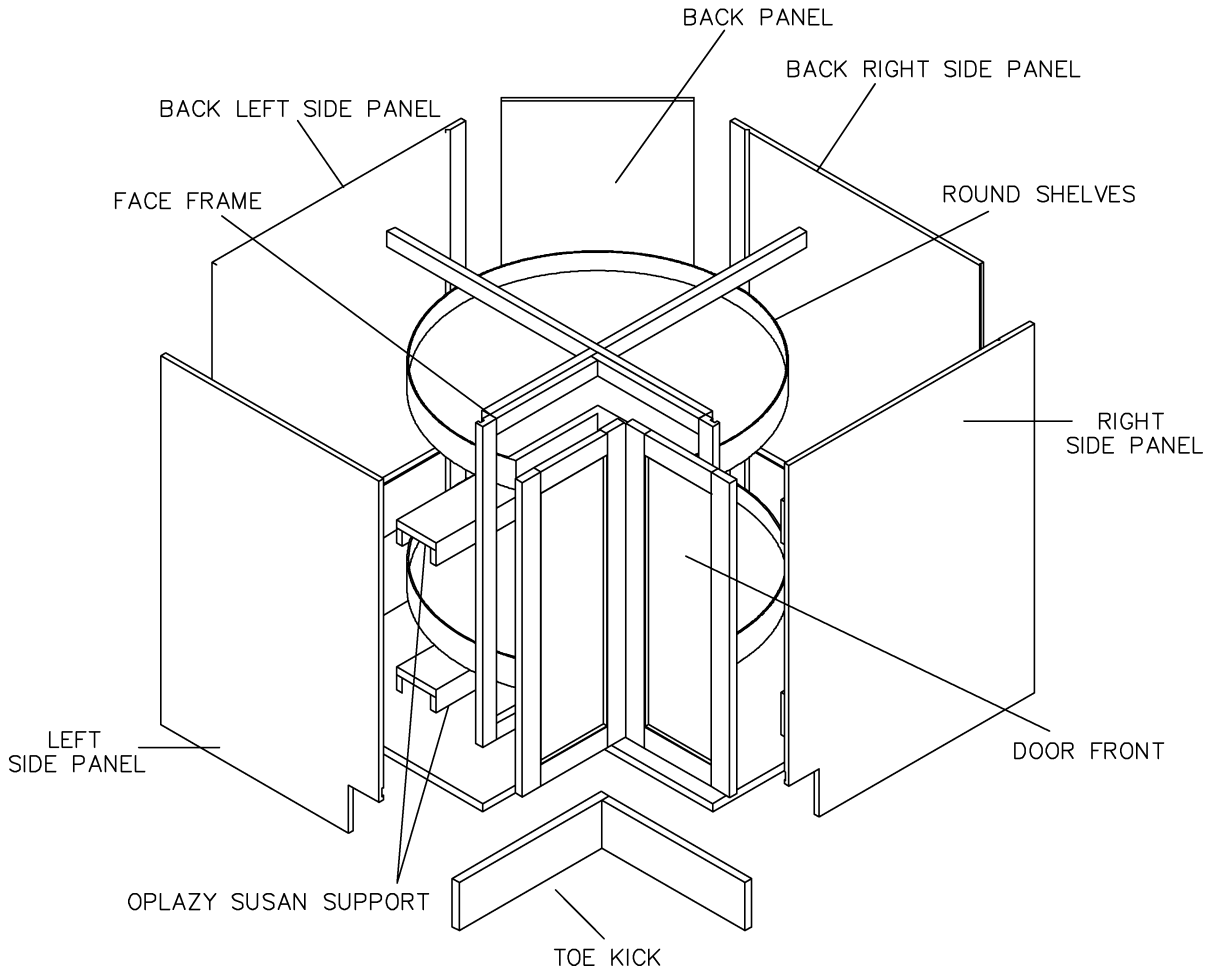

ASSEMBLY INSTRUCTIONS - LAZY SUSAN CORNER CABINET

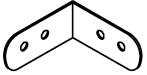
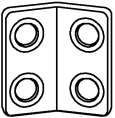

<p>METAL BRACKETS</p> 	<p>METAL BRACKETS</p> 	<p>BIFOLD HINGE</p>  <p>ES/DS/SG</p>	<p>170 HINGE</p> 	<p>SCREWS</p> 
---	---	---	--	---

TOOLS

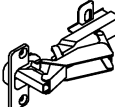
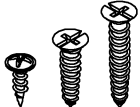
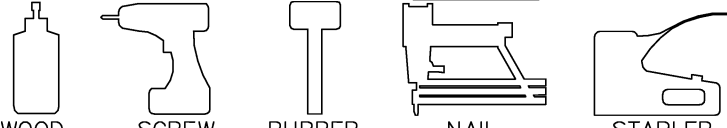

WOOD GLUE SCREW DRIVER RUBBER MALLET NAIL GUN STAPLER

This instruction applies to the following items:
LZS33, LZS3612

STEP 1

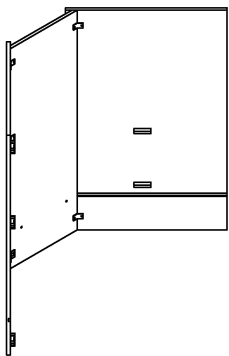

STEP 2

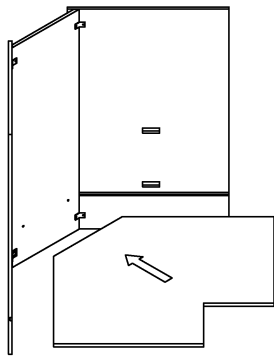

STEP 3

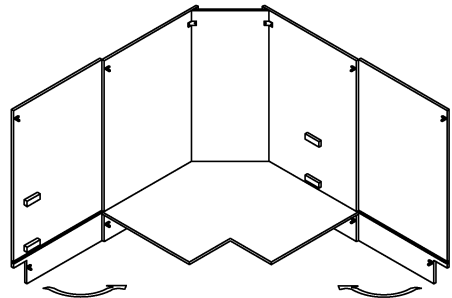

STEP 4

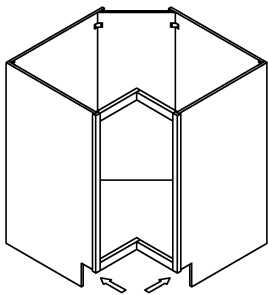

STEP 5

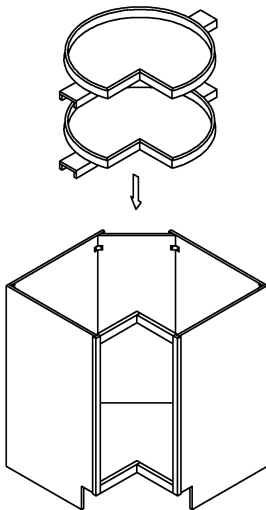

STEP 6

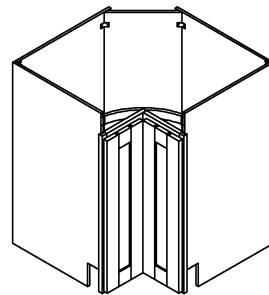

STEP 7

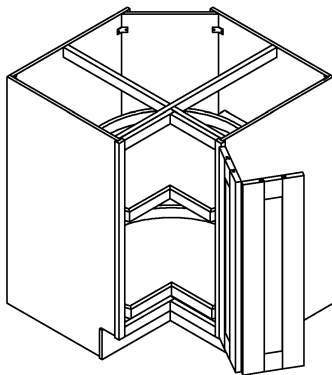

STEP 8

