

Installation Manual

Any question please contact us:
support@jubest.com

MYSD2P-34x84IN+HD

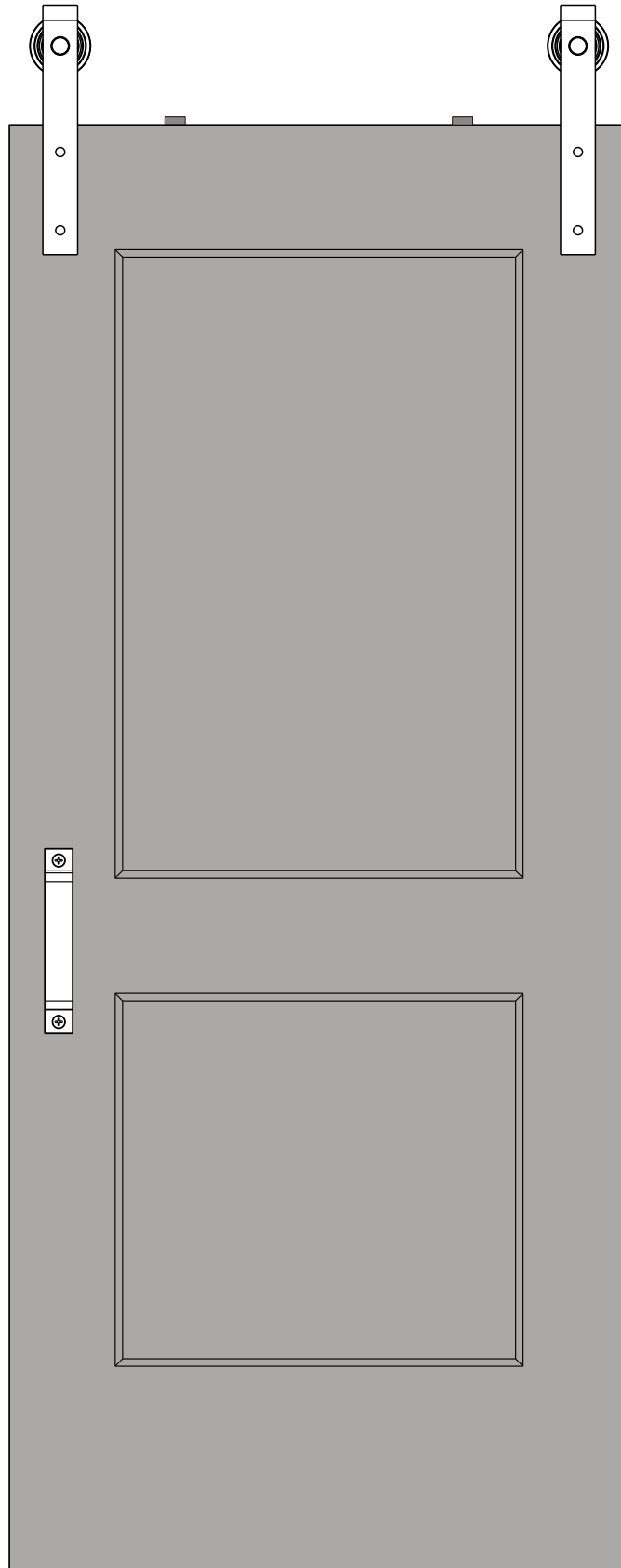

Pre-Installation

TOOLS REQUIRED

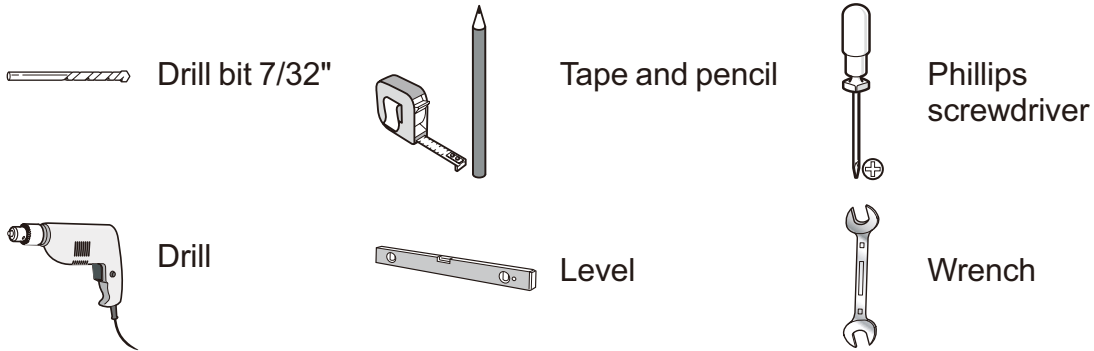

HARDWARE INCLUDED

 NOTE: Hardware not shown to actual size.

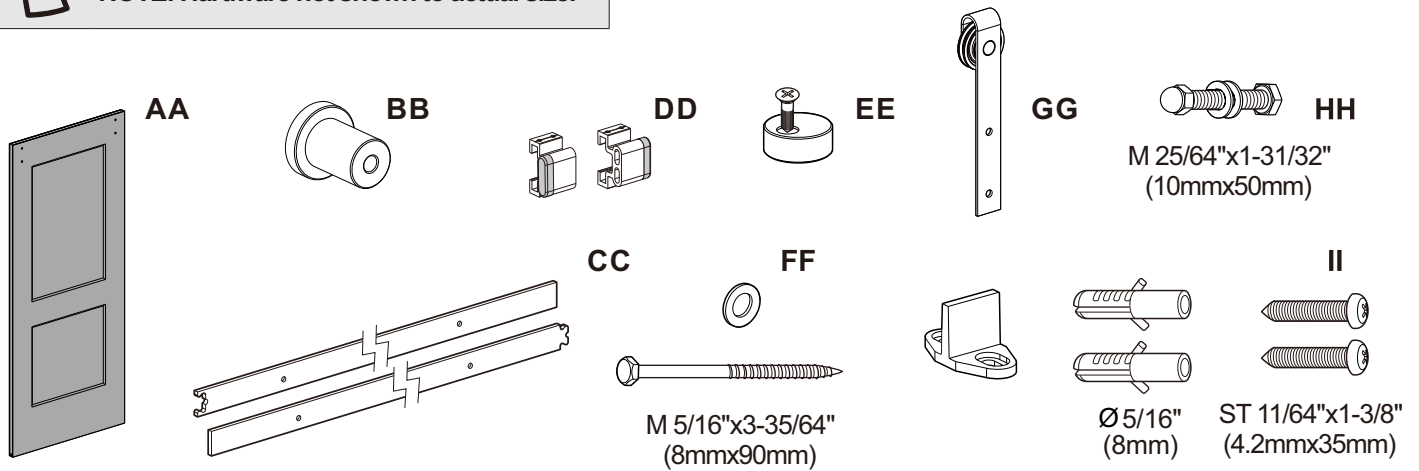

Part	Description	Quantity
AA	36x84 Door	1
BB	Spacer	5
CC	Rail	1
DD	Stopper	2
EE	Anti-Jump Disc with screw	2
FF	Lag screw with washer	5
GG	Door hanger	2
HH	Hanger door screw	4
II	Floor guide with screws	1
JJ	Handle with screws	1
KK	Allen key	1
LL	Anchor Floor	5

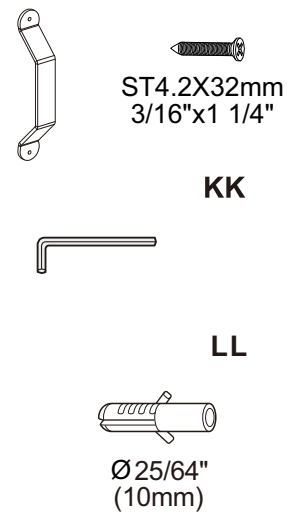

1 Locating Studs

- With a stud finder locate the studs near the door opening.

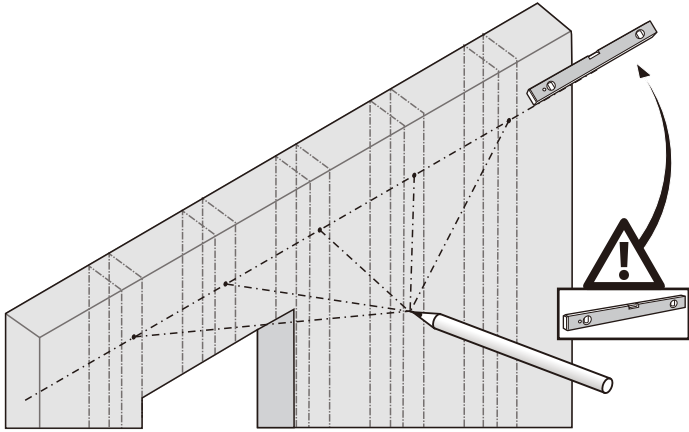

2 Measuring Height

- From the floor, measure 85-11/16" (2177mm) to determine the center height of the rail.

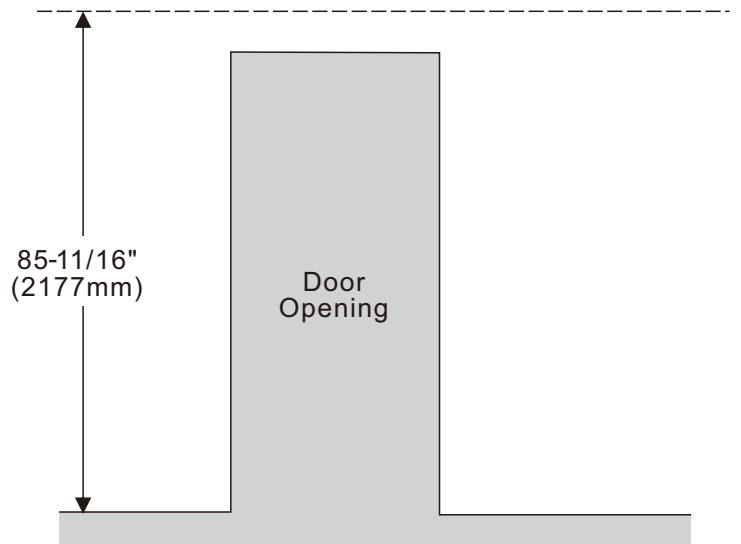

Installation (continued)

3 Drilling Pilot Holes

- Position the rail on the wall so that the height pass in the middle of each hole.
- Mark the location for each lag screw over the studs.
- Drill $25/64$ " pilot holes at each mark.
- Insert the provided anchors(LL) into the holes.

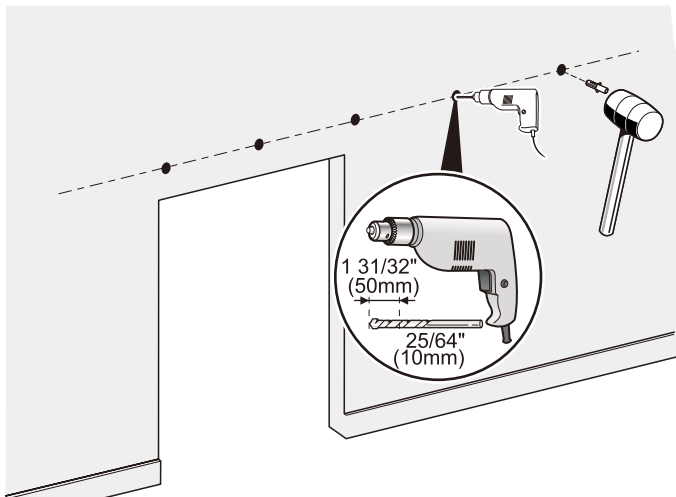
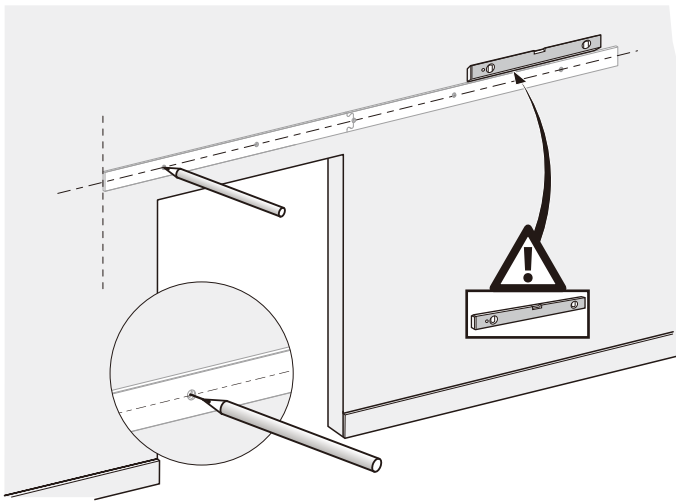

4 Installing the rail



CAUTION: If the rail is not installed level, the door may slide open or closed without warning.

- Assemble the two rails (CC) together.
- Place one lag screw with washer (FF) through the middle hole then through a spacer (BB). Do not fully tighten.
- Repeat process with holes that are at the ends of the rail.
- Use a level on top of the rail to ensure it is properly levelled.
- Tighten the three lag screws completely.
- Repeat for the two remaining lag screws and spacers.

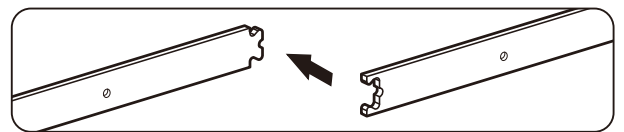
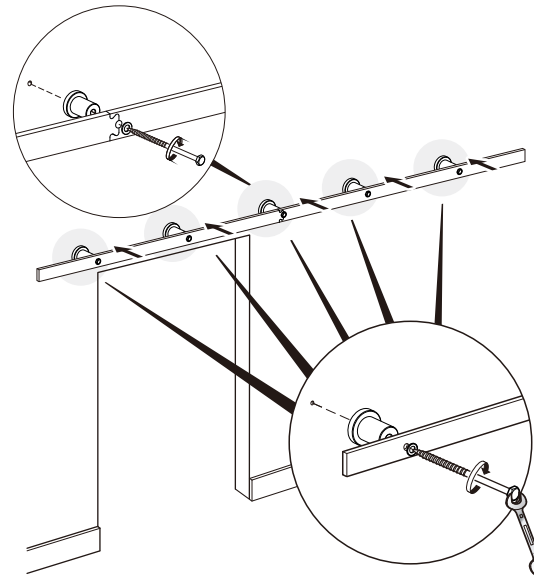

Installation (continued)

5 Fixing Door Hangers

- Insert the bolt BB with washer through the back of the door and secure the door hanger with washer and nut. Repeat on other side.

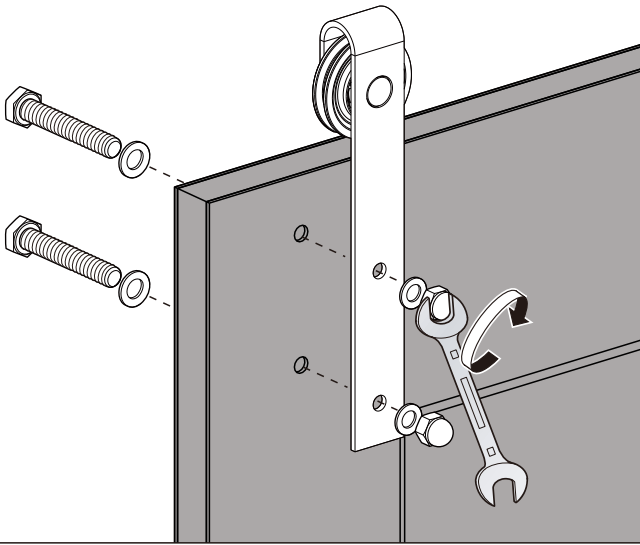

6 Fixing Anti-Jump Discs

- Loosely fasten the anti-jump discs (EE) 2" (50mm) from each door hanger.
- To be able to install the door on the rail, anti-jump discs must be turned towards the front of the door.

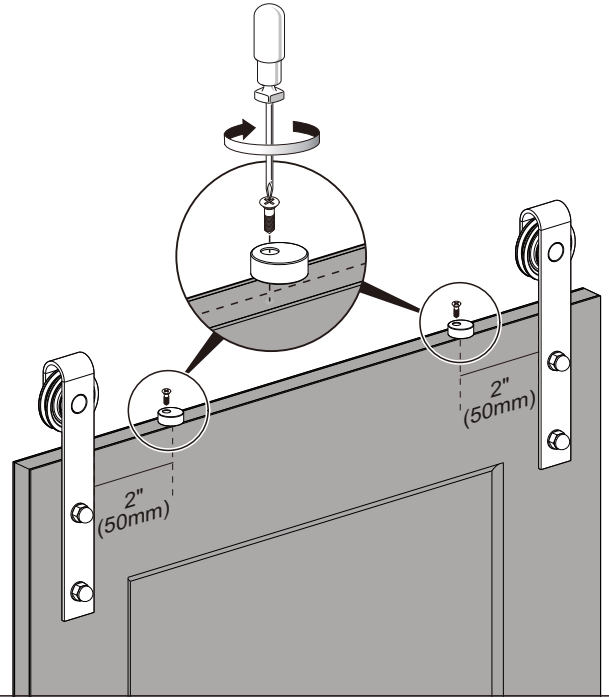

7 Hanging the Door

- Hang the door on the rail. (figure 1)
- Rotate anti-jump discs so they are positioned on top of the door and underneath the rail. (figure 2)
- Tighten the screws.

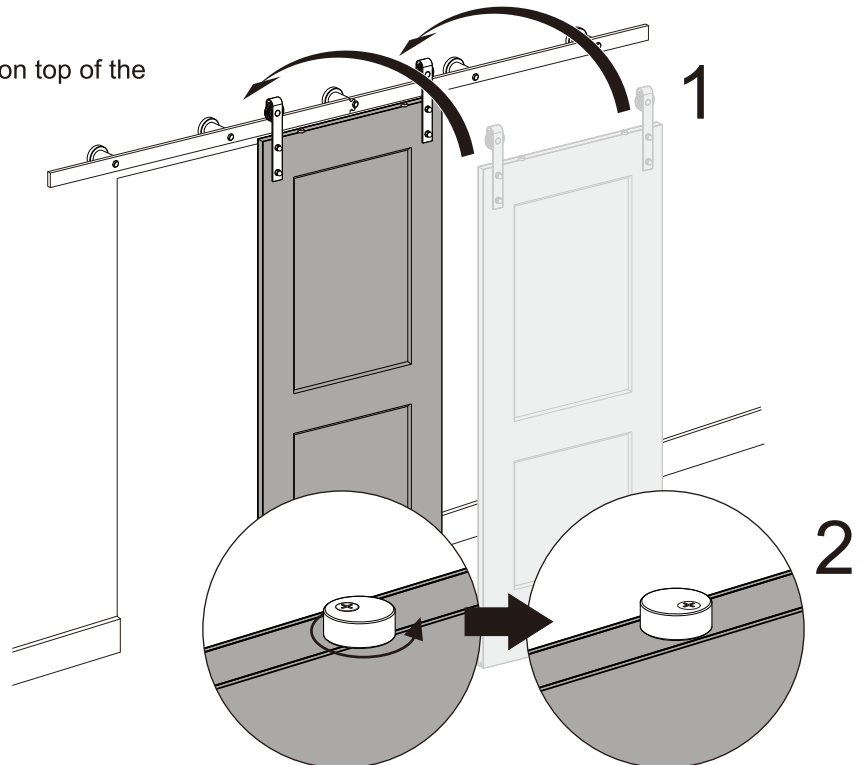

Installation (continued)

8 Installing Floor Guide

- Ensure the door is levelled.
- Align floor guide (II) with the bottom groove of the door.
- Fix the floor guide on the opening side, as close to the doorway as possible.

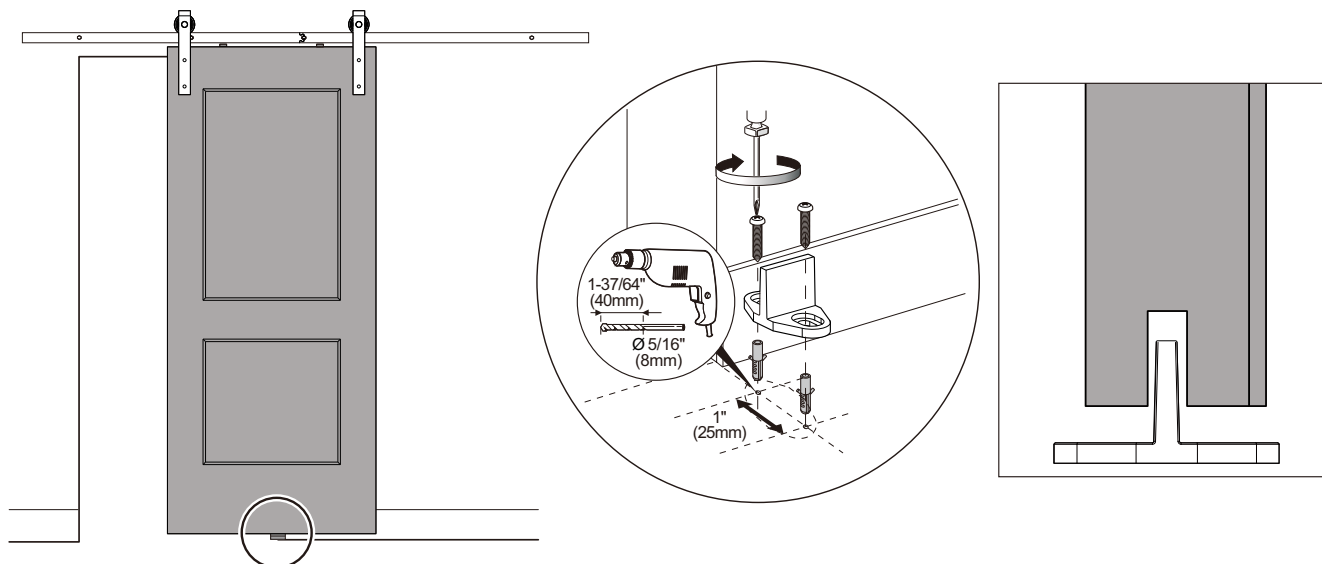

9 Securing Door Stoppers



IMPORTANT: Stoppers are used to avoid the door from rolling out the edge of the rail on both ends.

- Close the door to the desired position.
- Insert and secure the door stopper (DD) by tightening the screw.
- Open the door to the desired position.
- Insert and secure the door stopper (DD) by tightening the screw

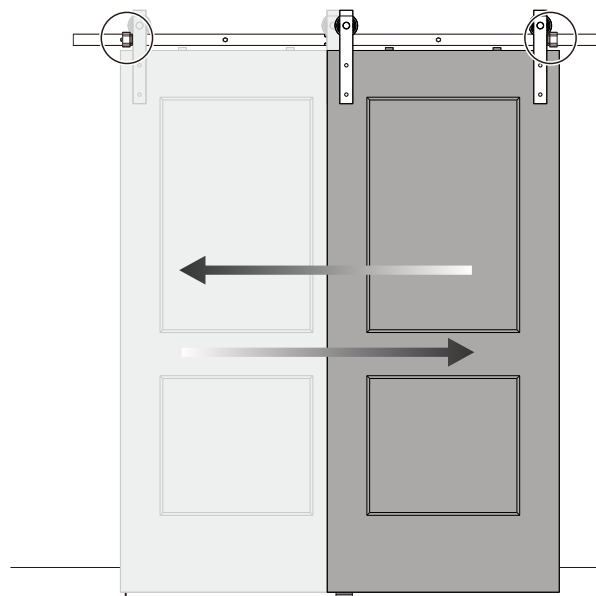
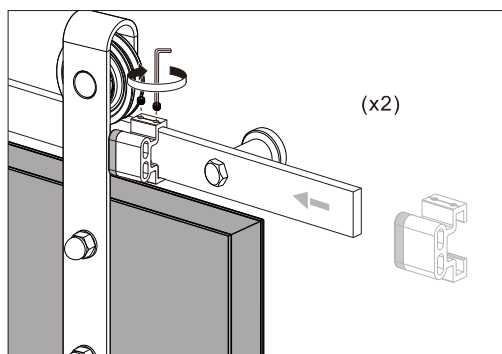

10 Installing Door Handle

- Put handle in place.
- Secure with screws.

