

INSTRUCTION
 ANWEISUNG
 取扱説明書
 INSTRUCTION

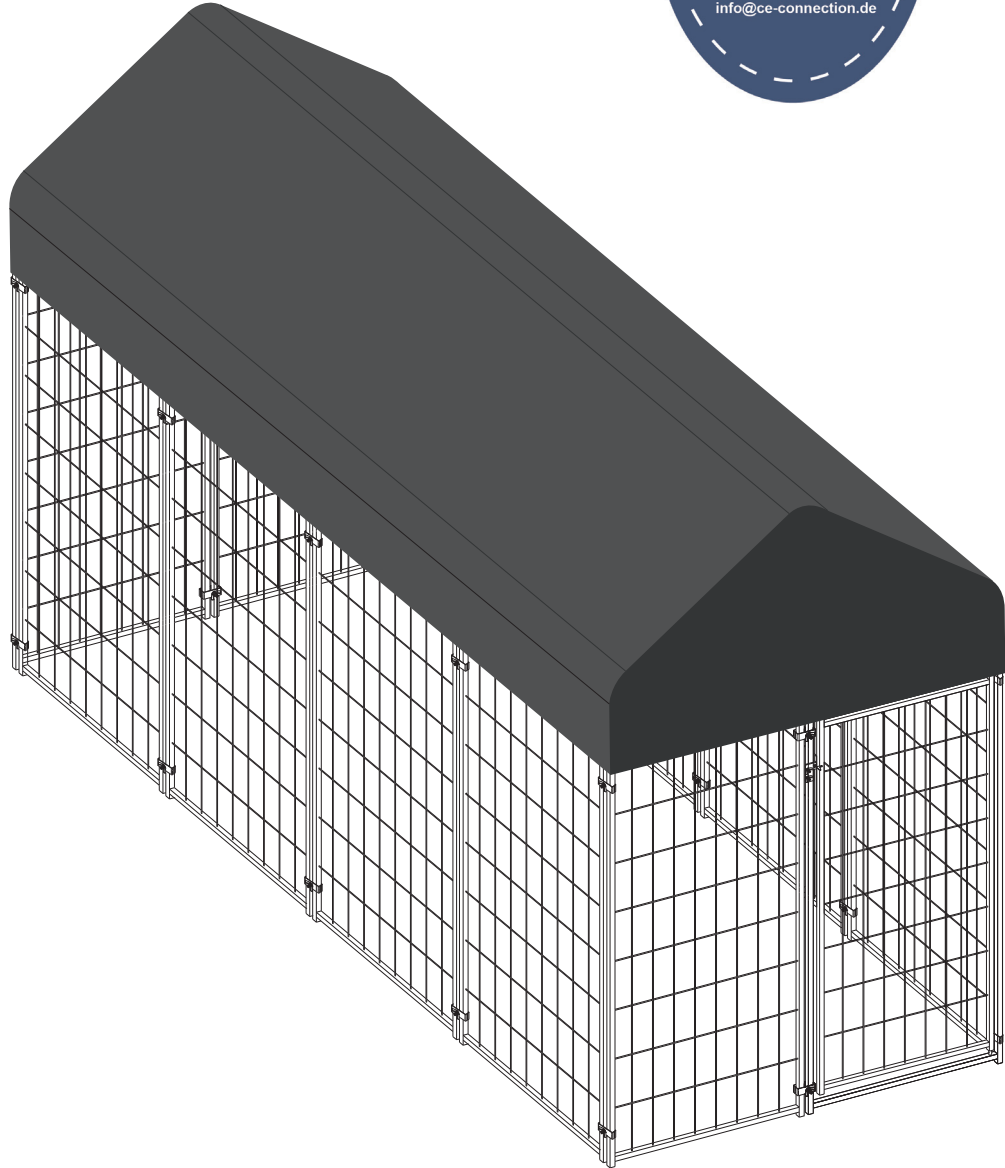

A *11

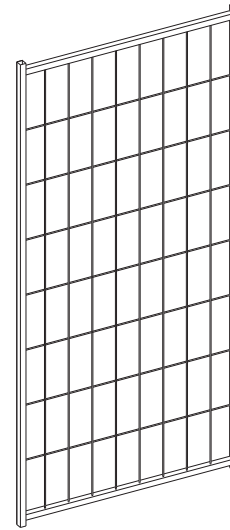

B *3

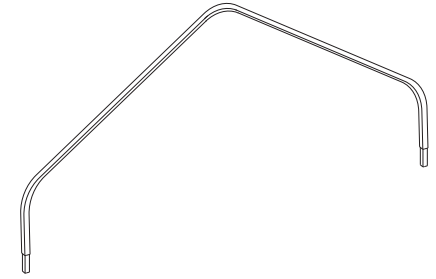

D *1

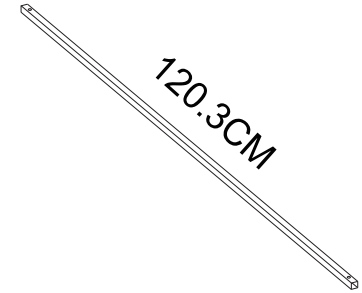

C *1

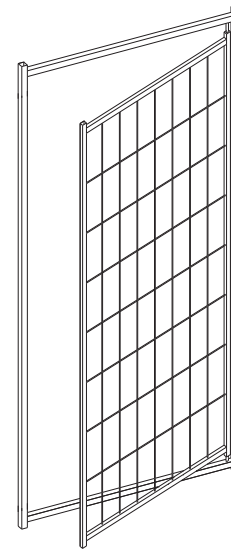

E *1

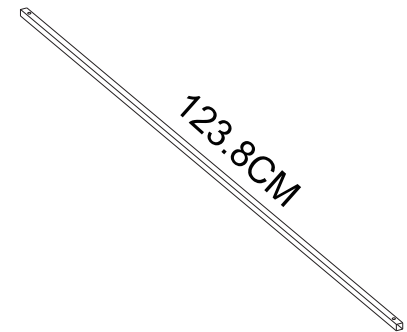

F *24



G *2

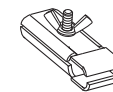

H *2

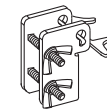

J *1

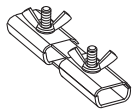

K *12



L *20



M *1

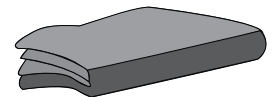

1

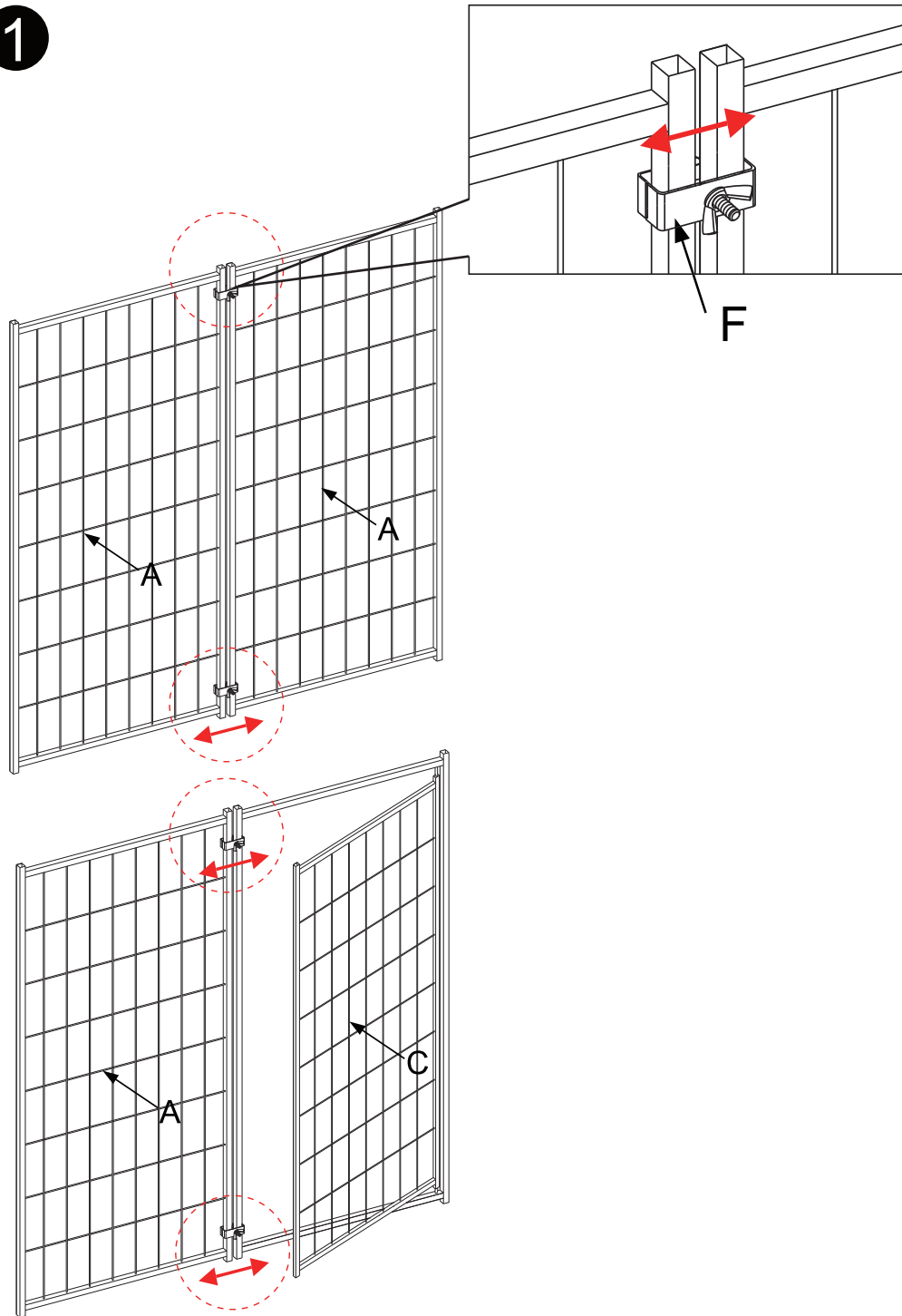

2

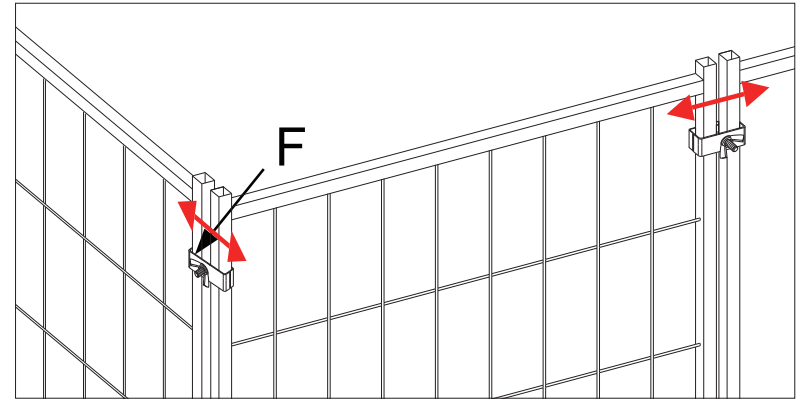

2.Install the F as picture shown

2.Bitte verbinden Sie sich mit F, wie das bild zeigt.

2.まず、部品Fで、板を2枚ずつそれぞれ接続します。次、上図のように部品Fで板を垂直に接続します。

2.Connectez F dans le sens indiqué sur l'image

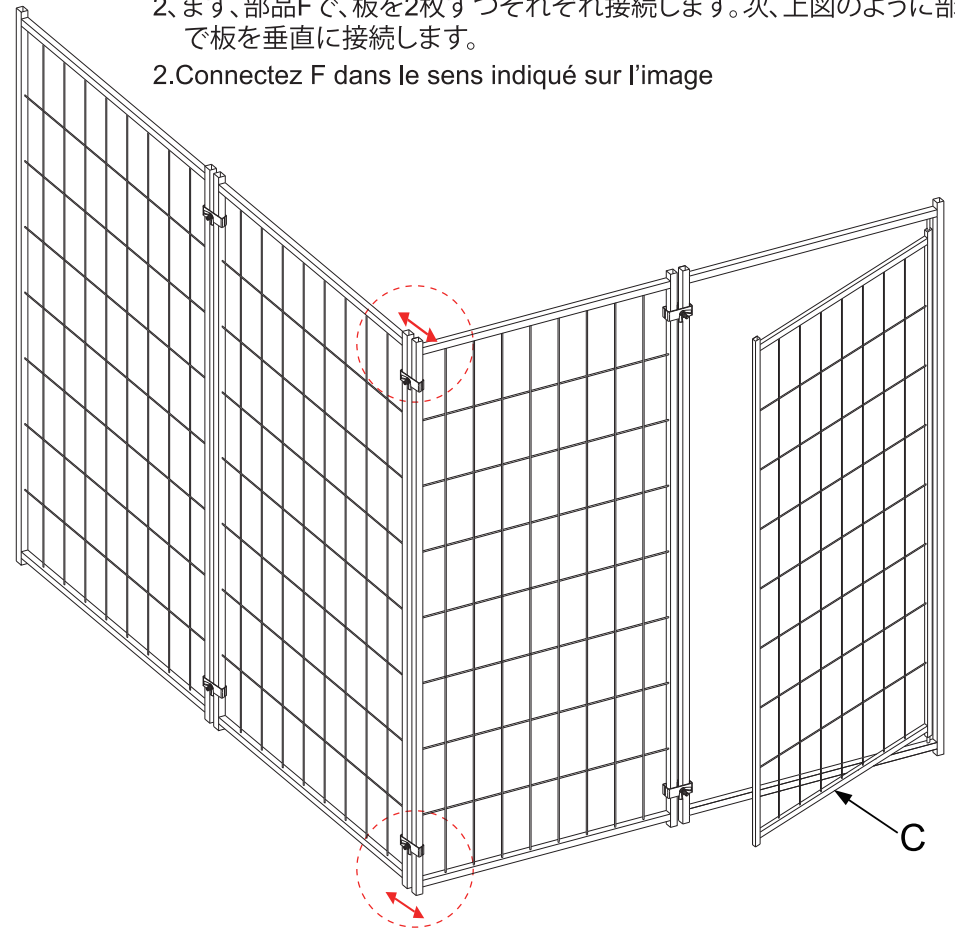

3

3. Follow the way of Step 2 to install next parts.

3. Befolgen Sie Schritt zwei zur Installation.

3. 別の板も接続します。

3. Installer selon l'étape 2

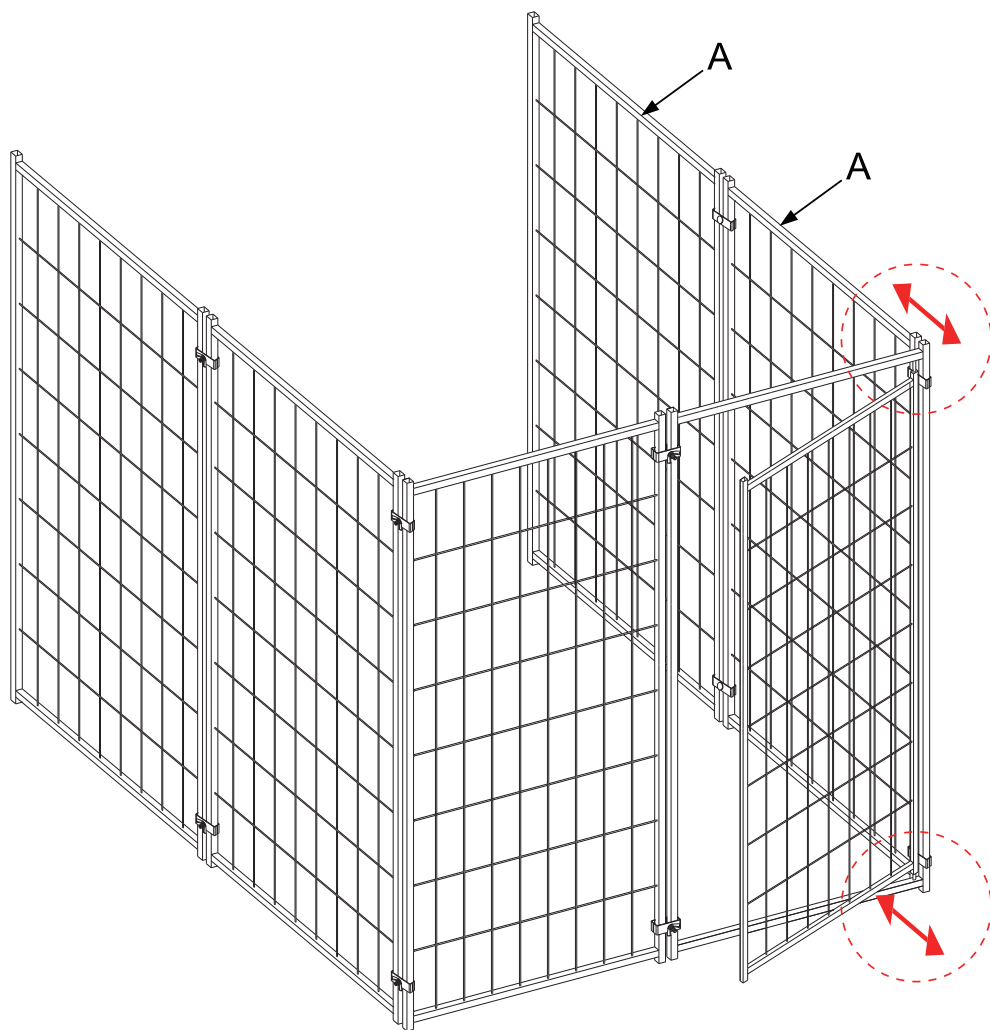

4

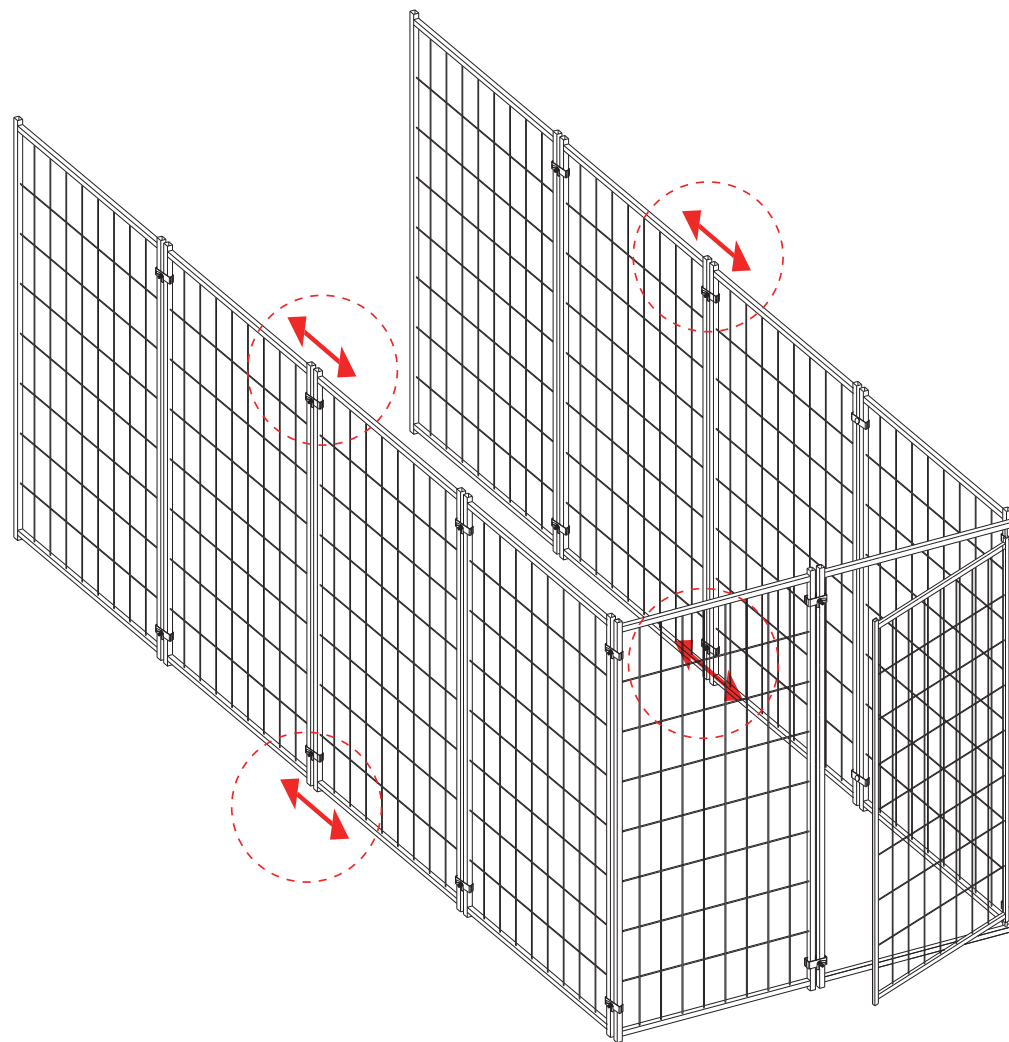

5

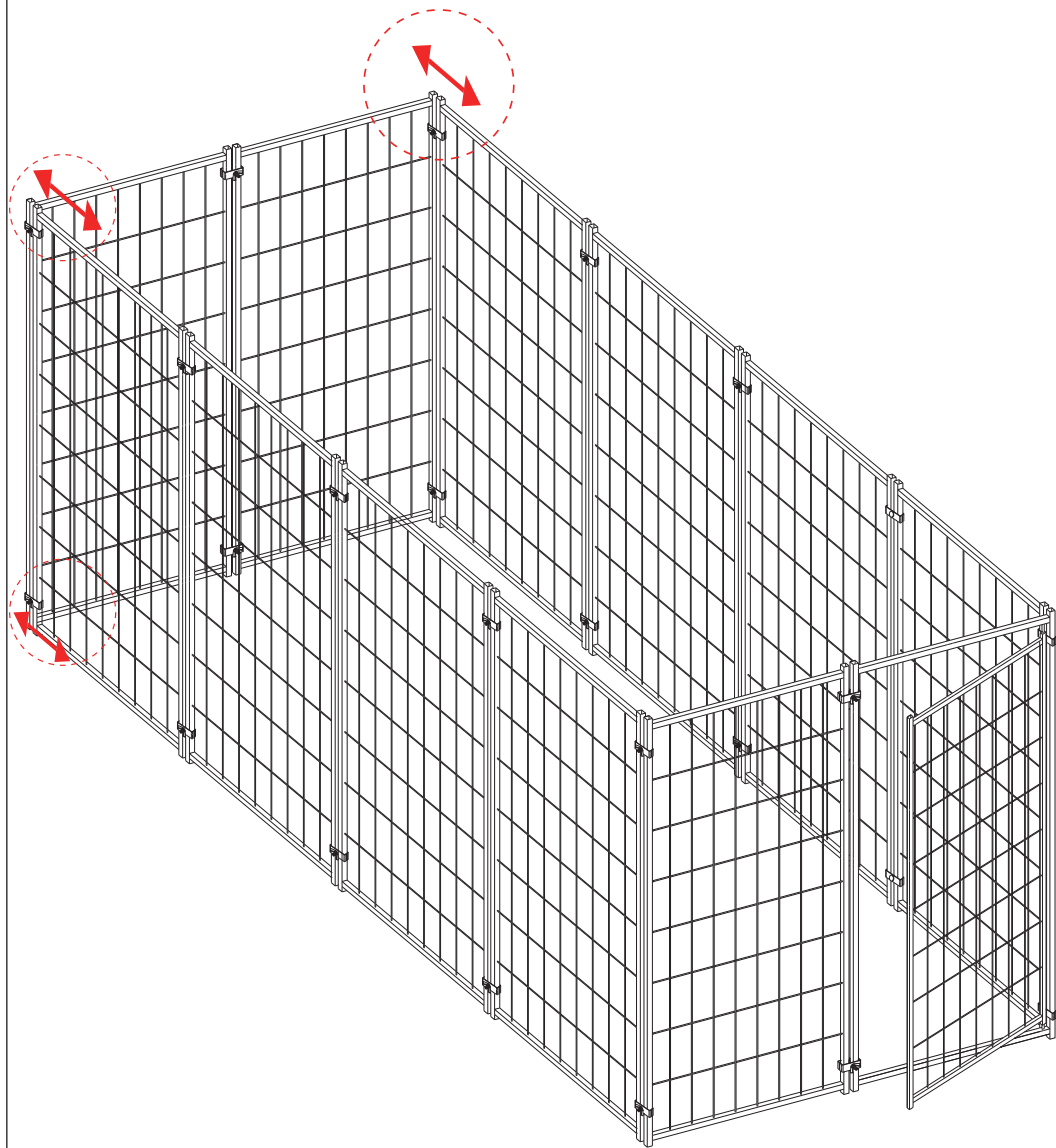

6

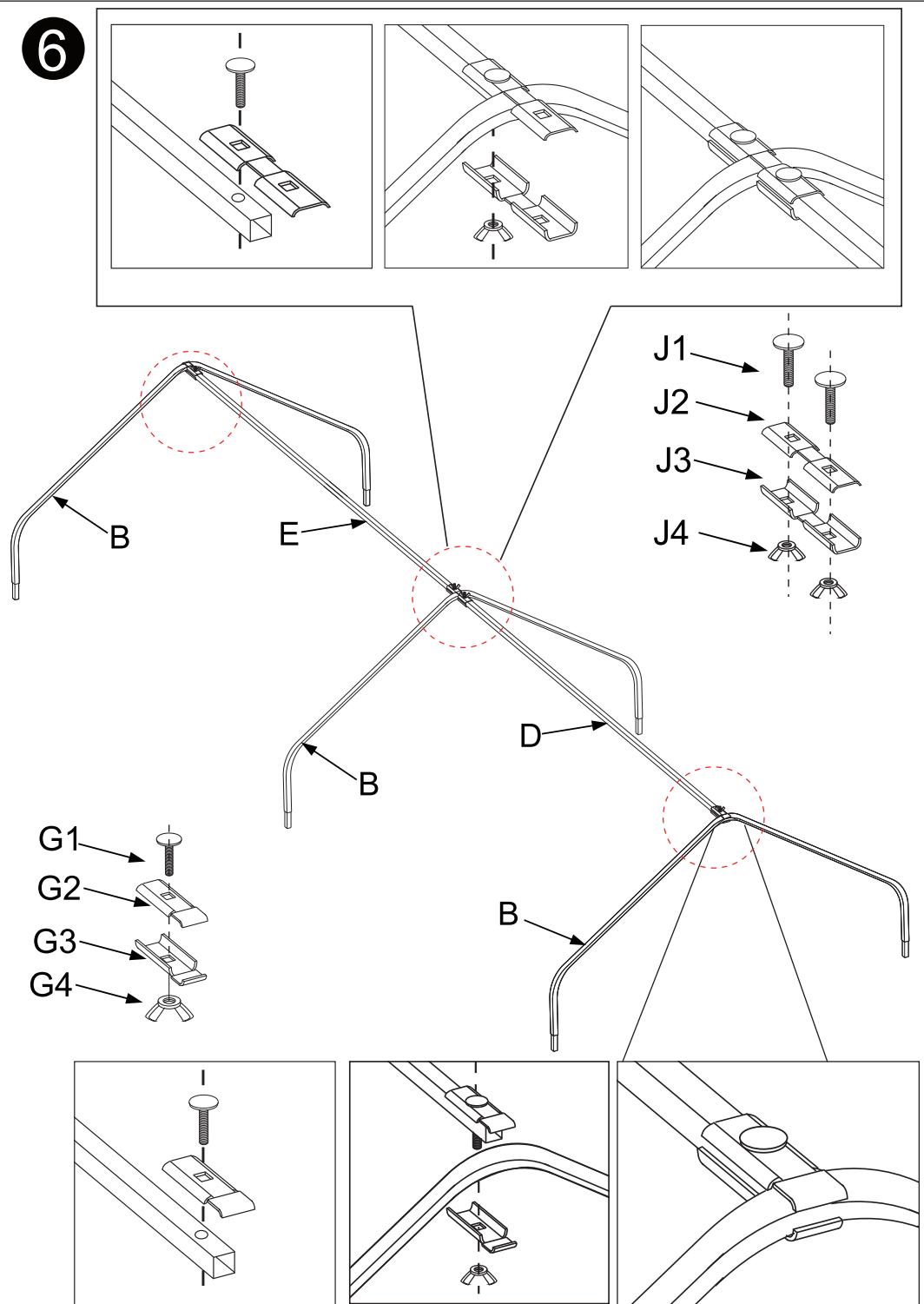

7

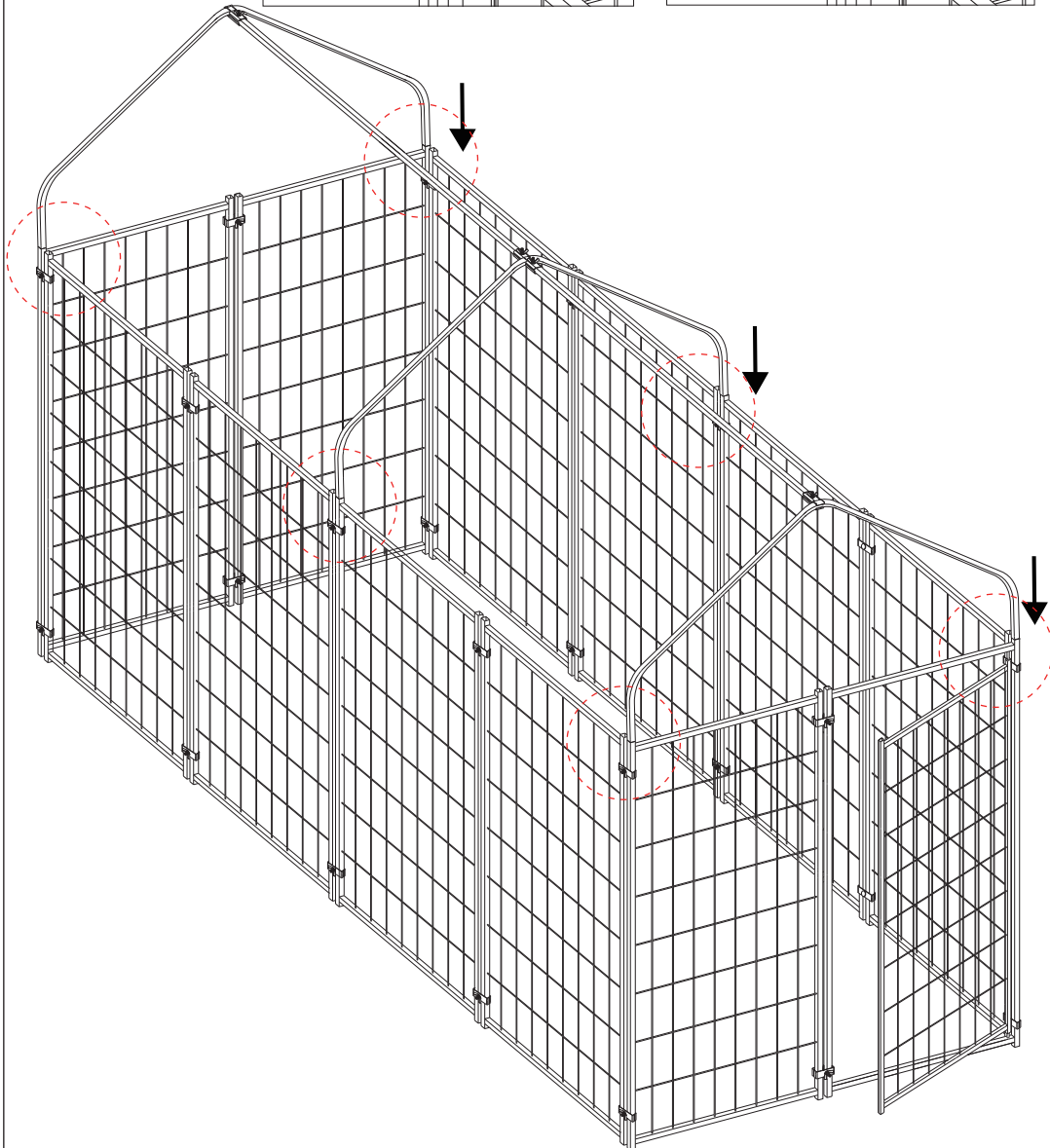
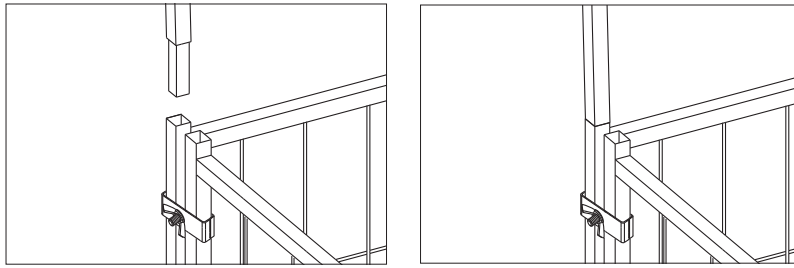

8

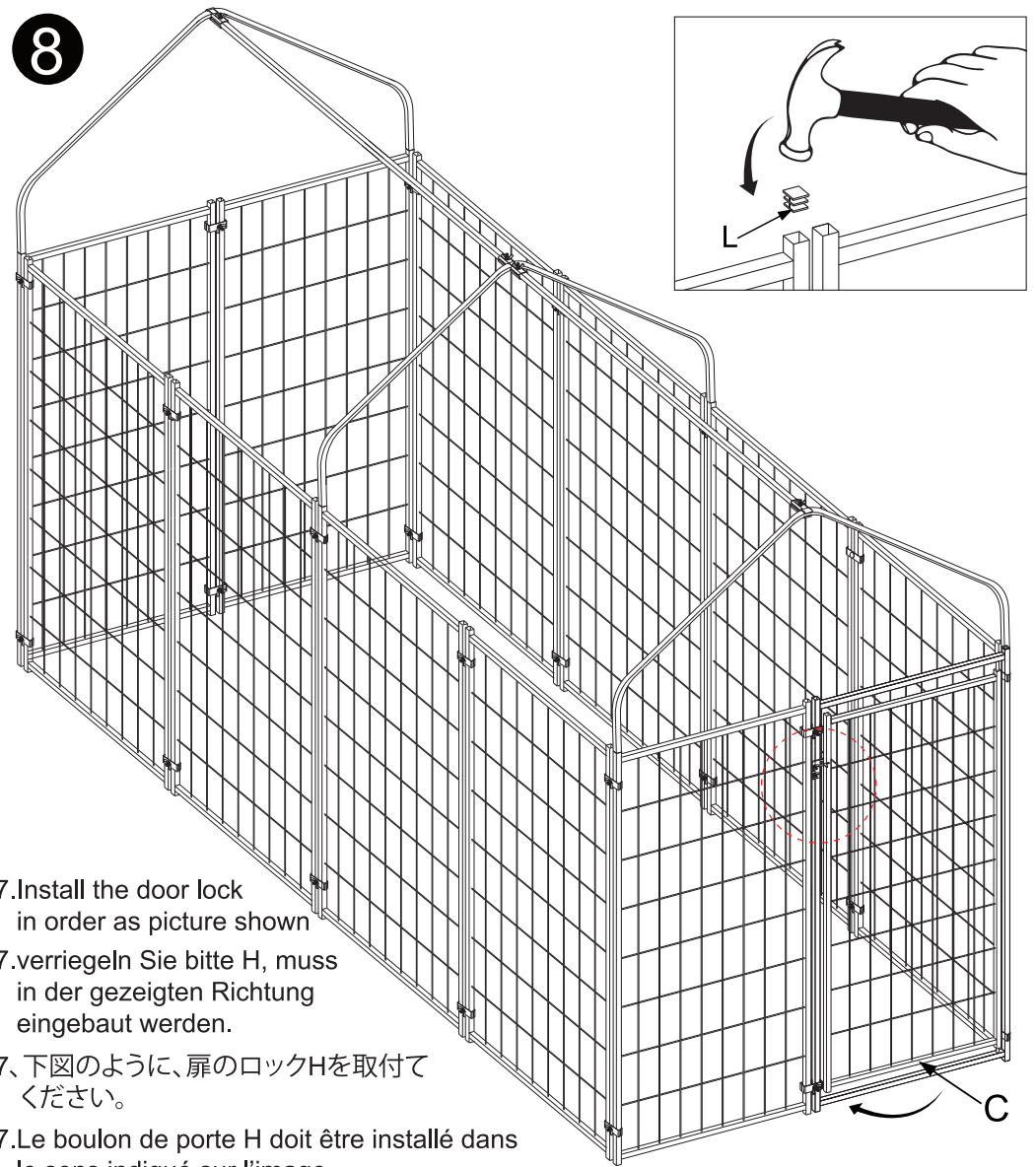
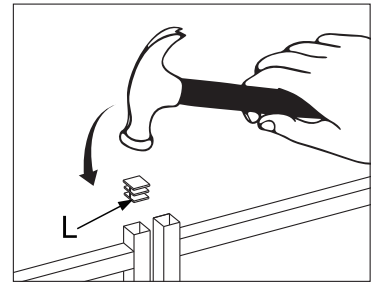

7. Install the door lock in order as picture shown

7.verriegeln Sie bitte H, muss in der gezeigten Richtung eingebaut werden.

7、下図のように、扉のロックHを取付けてください。

7.Le boulon de porte H doit être installé dans le sens indiqué sur l'image

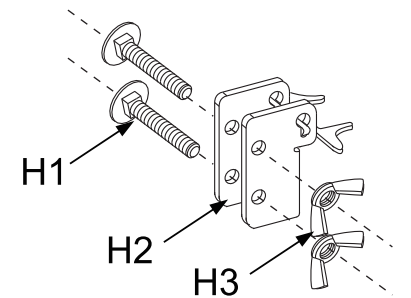
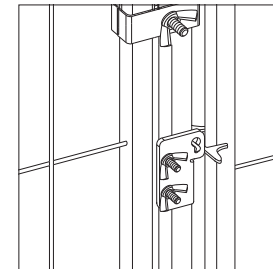
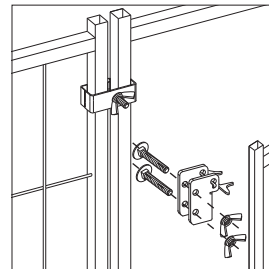

9

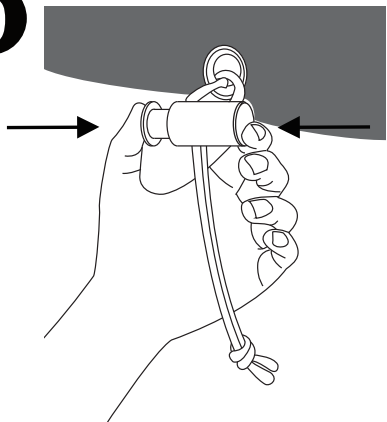

9. Press the two sides of the rope button to adjust the rope and make the cover fix on the cage

9. Halten Sie die beiden Enden der Seileinstellschnalle gedrückt und befestigen Sie das M am Hundekäfig.

9. カバーで屋根を覆った後、カバーの紐を絞めてからパイプに留めます。

9. Tout en tenant les deux extrémités de la boucle de réglage de la corde, attachez le M à la cage pour chien.

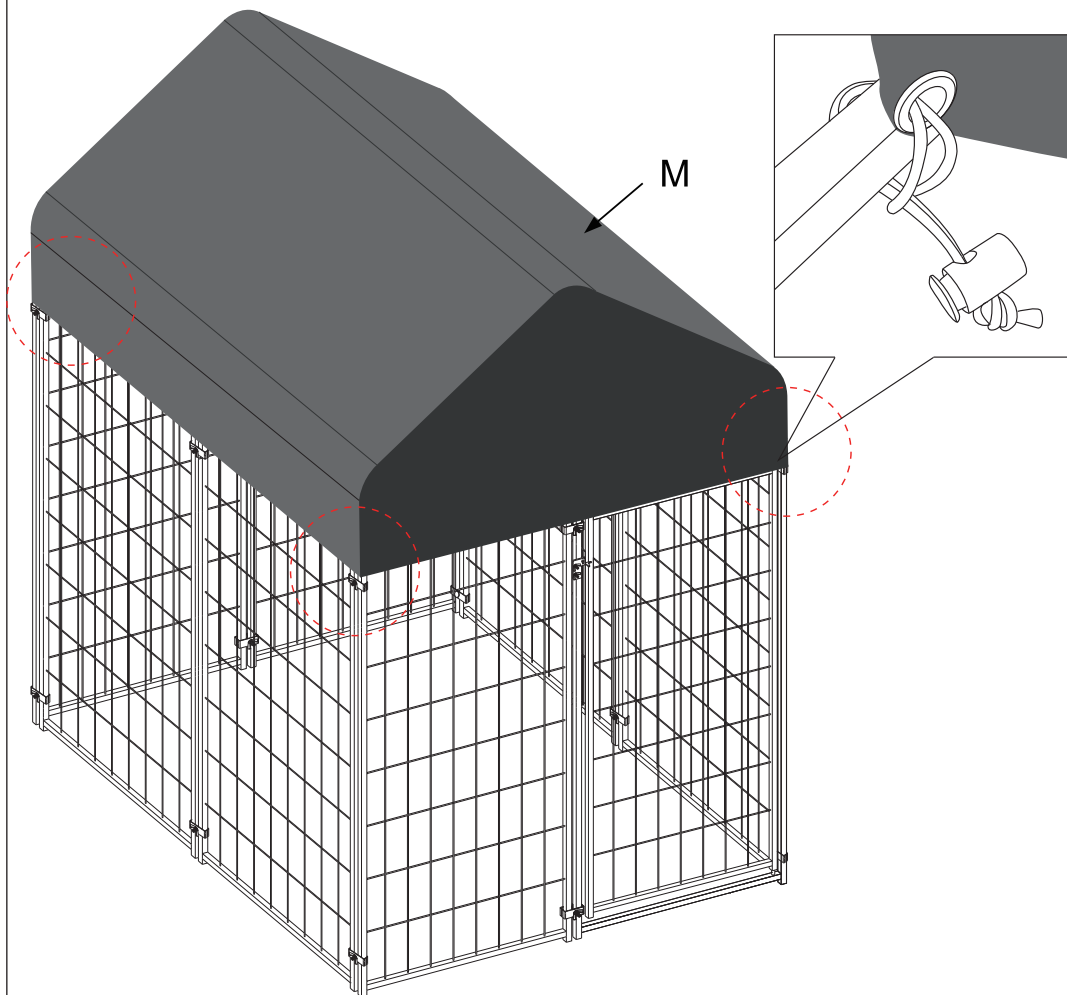

10

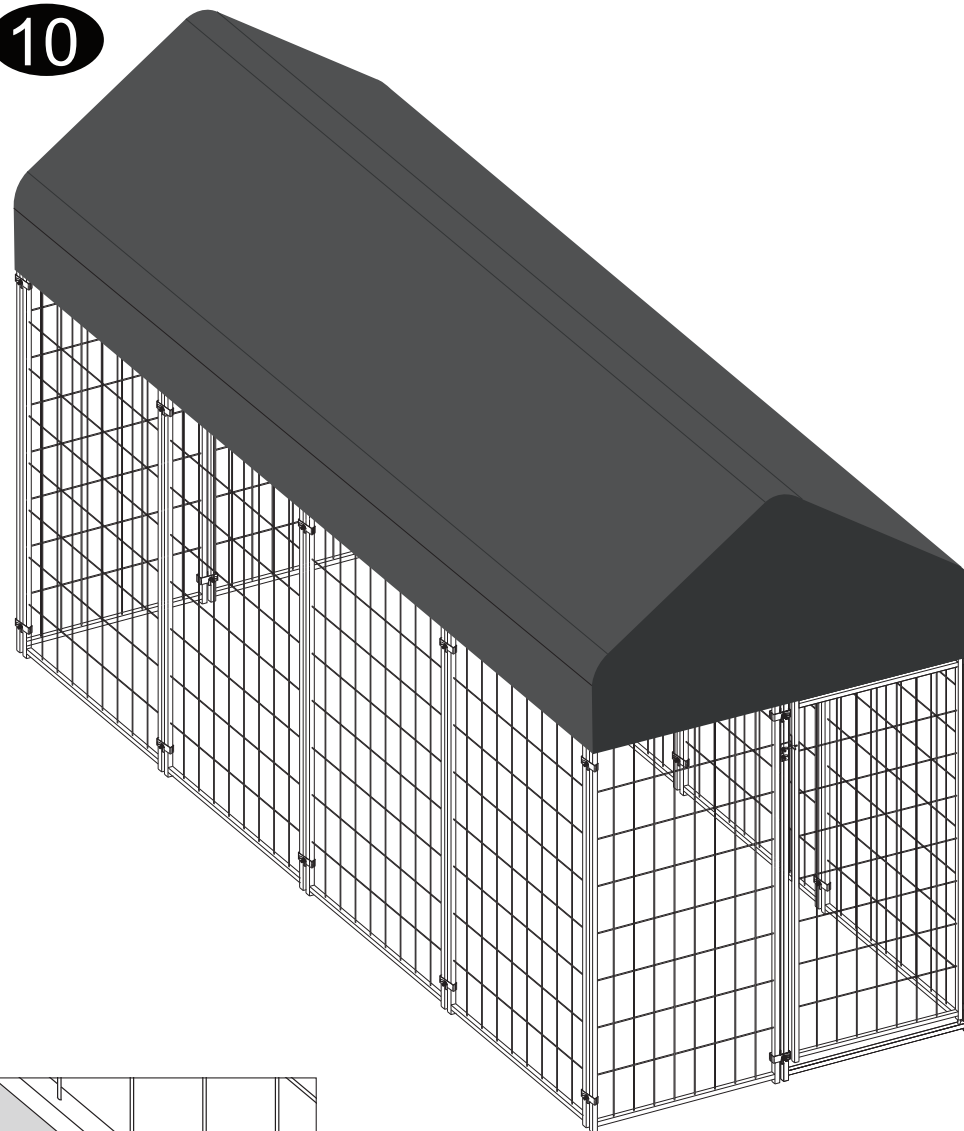

10. You can use soil stakes to make the dog cage stay more solid and stable in outside

10. Wenn Sie der Käfig in Außen verwenden möchten, stecken K in den Boden, damit es nicht zusammenfällt.

10. 屋外で使う場合には、フックKで地面に固定することができます。

10. Si vous souhaitez utiliser la cage à l'extérieur, mettez K en bas pour qu'elle ne s'effondre pas.

