

# Installation & Assembly

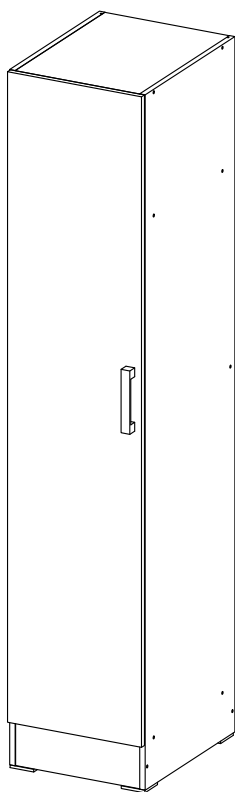

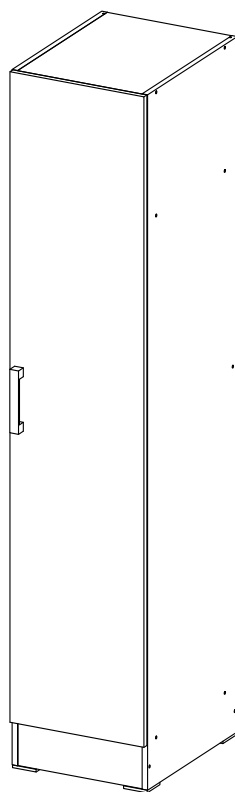



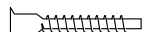

Door Open  
**RIGHT**

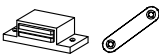

Door Open  
**LEFT**

HARDWARE LIST			QTY (pcs)
A2		Screw m3.5 x 14mm	52
A7		Screw m4 x 30mm	2
A17		Crosshead Screw m6.3 x 40mm	18
D4		Wood Dowel 6 x 25mm	14
E5		Soft Closing Hinge 5/8	3
E21		Anti-Tipping Pack	1 set
H21		Handle 128mm	1

K2		Magnet Catch_5KG	1
L2		Plastic Leg L Shape	4
N1		Allen Key	1
P		Hanging Steel Pipe 18mm x 354mm	1
Q4		Plastic Shelf Support with Steel Pin	12
R2		Single Plastic Cap	14
Y		Crosshead Cover	18

**\* Extra screw for your commitment.**

**\* Please assemble flat or nice service.**

# **"Congratulations on Your Recent Purchase! Here Are Some Tips Before You Begin Assembling:"**

"Preparing for your exciting new purchase? Be sure to set yourself up for a smooth assembly process by following these steps:"

- First, we recommend using a rug or any large clean surface as your workspace to provide a sturdy base for assembly.
- Next, it is important to separate all components and identify each part by their designated letters. This will make it easier to follow the assembly instructions and ensure all pieces are placed correctly.
- Additionally, on a clean surface separate and identify all screws lengths and hardware. You can use the assembly instructions as a guide and place the screws on top of the actual size pictured. This will save you time and confusion during the assembly process.
- Finally, we highly encourage you to carefully read through the assembly instructions and start from step one. Follow each step diligently until your new purchase is fully assembled. However, if you have any questions or need further assistance, please do not hesitate to reach out to us via email.

**Thank you again for choosing our product.  
We wish you all the best and happy assembling!**

Place your screw on top of the scale to identify their size.

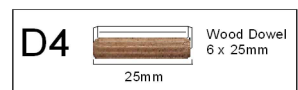
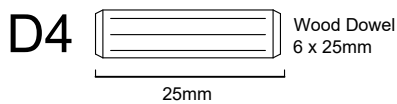
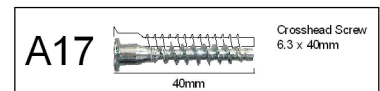
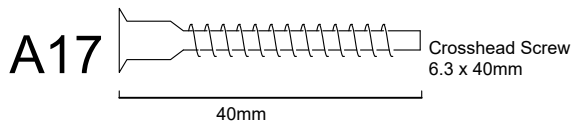
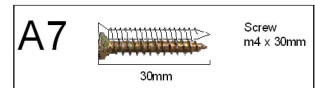
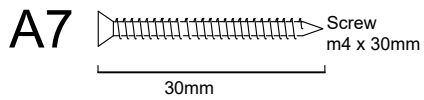
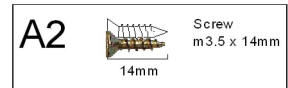
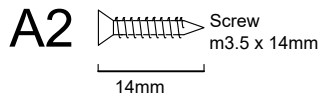

Reversible Door

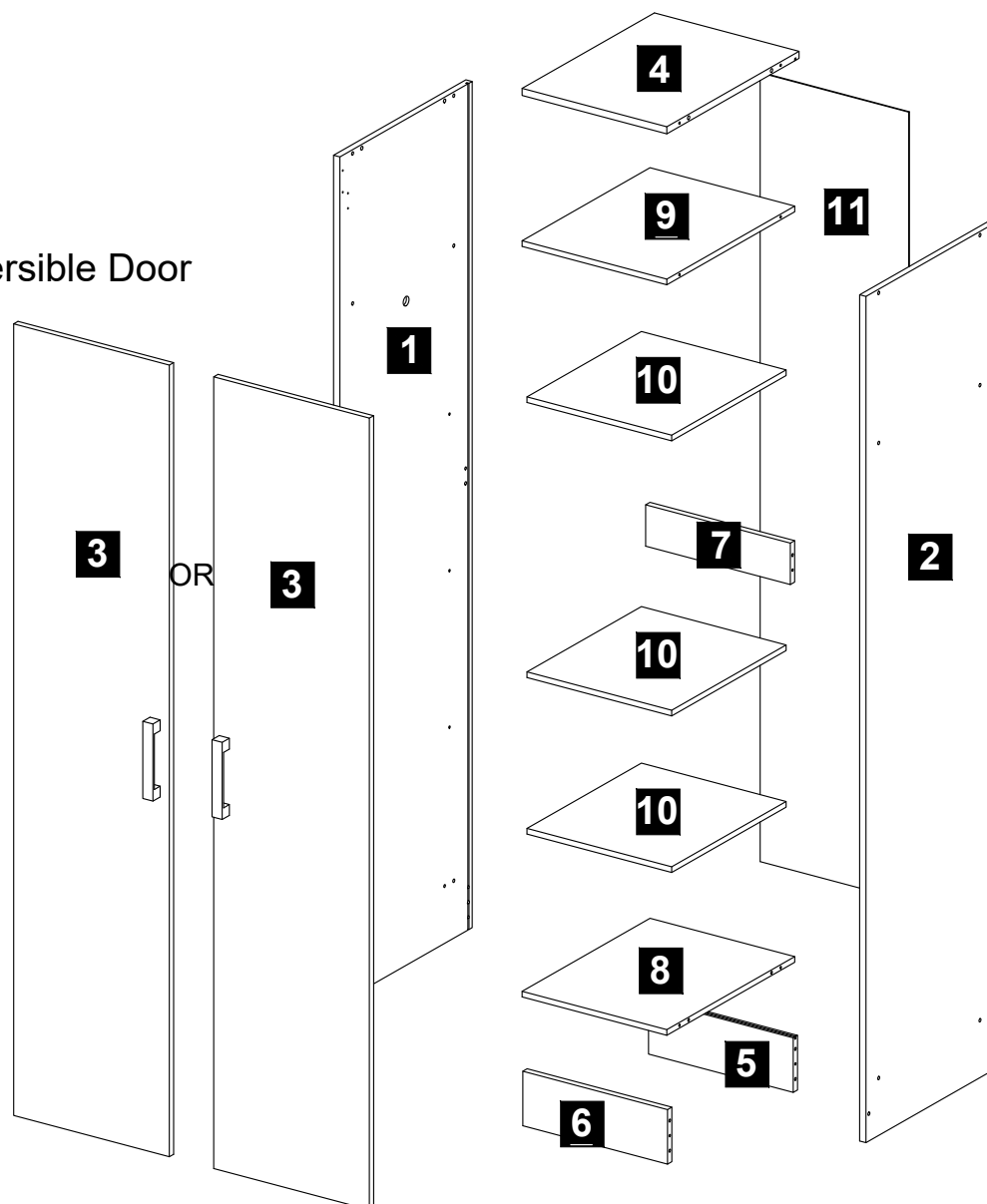

Parts List		
1	Side Panel (L)	1 pc
2	Side Panel (R)	1 pc
3	Door Panel	1 pc
4	Top Panel	1 pc
5	Crossbar	1 pc

6	Crossbar Panel	1 pc
7	Small Crossbar	1 pc
8	Base Panel	1 pc
9	Shelf Panel	1 pc
10	Small Shelf Panel	3 pcs
11	Backboard	1 pc

**\*EACH PART IS LABELLED ACCORDING TO THE PARTS LIST\***



Before starting assembly  
please verify if all parts and  
hardware are included

# STEP 1

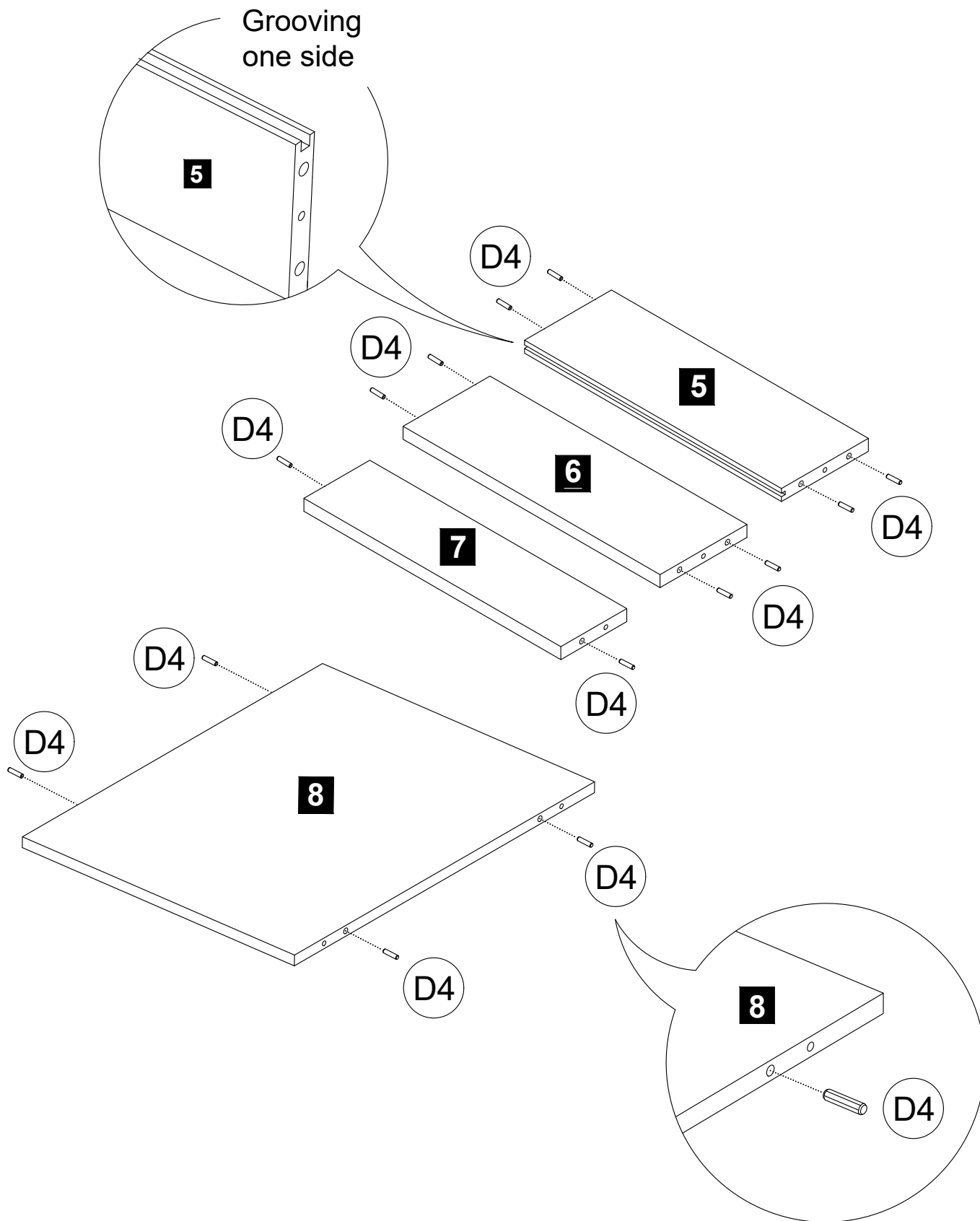



D4		Wood Dowel 6 x 25mm	14 pcs
----	---	---------------------	--------

# STEP 2

## ATTENTION !

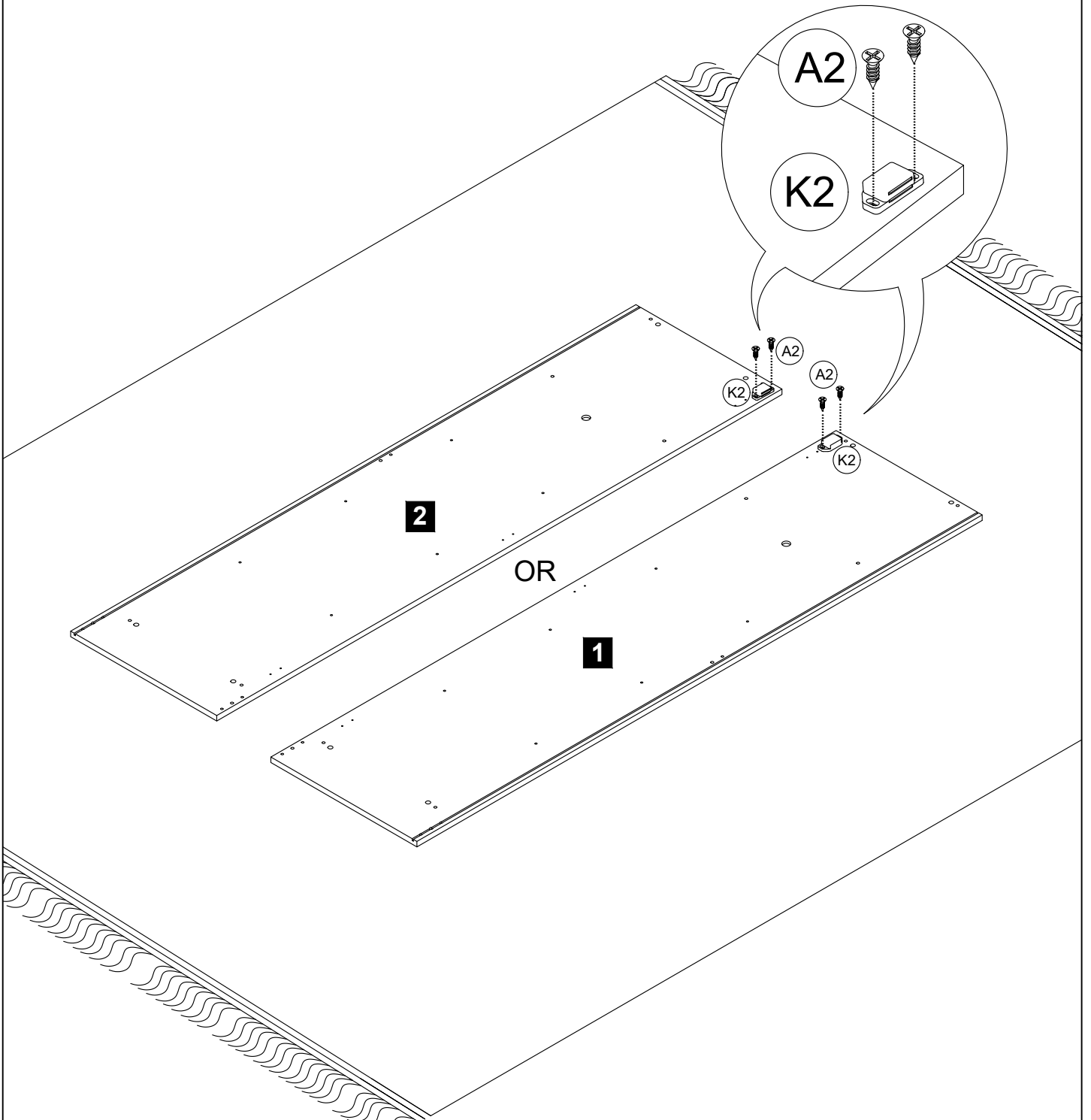

If door open **Left** , place **K2** at panel no **1**  
If door open **Right** , place **K2** at panel no **2**  
Assemble the panel on a clean surface / rug



A2		Screw m3.5 x 14mm	2 pcs
K2		Magnet Catch_5kg	1 pc

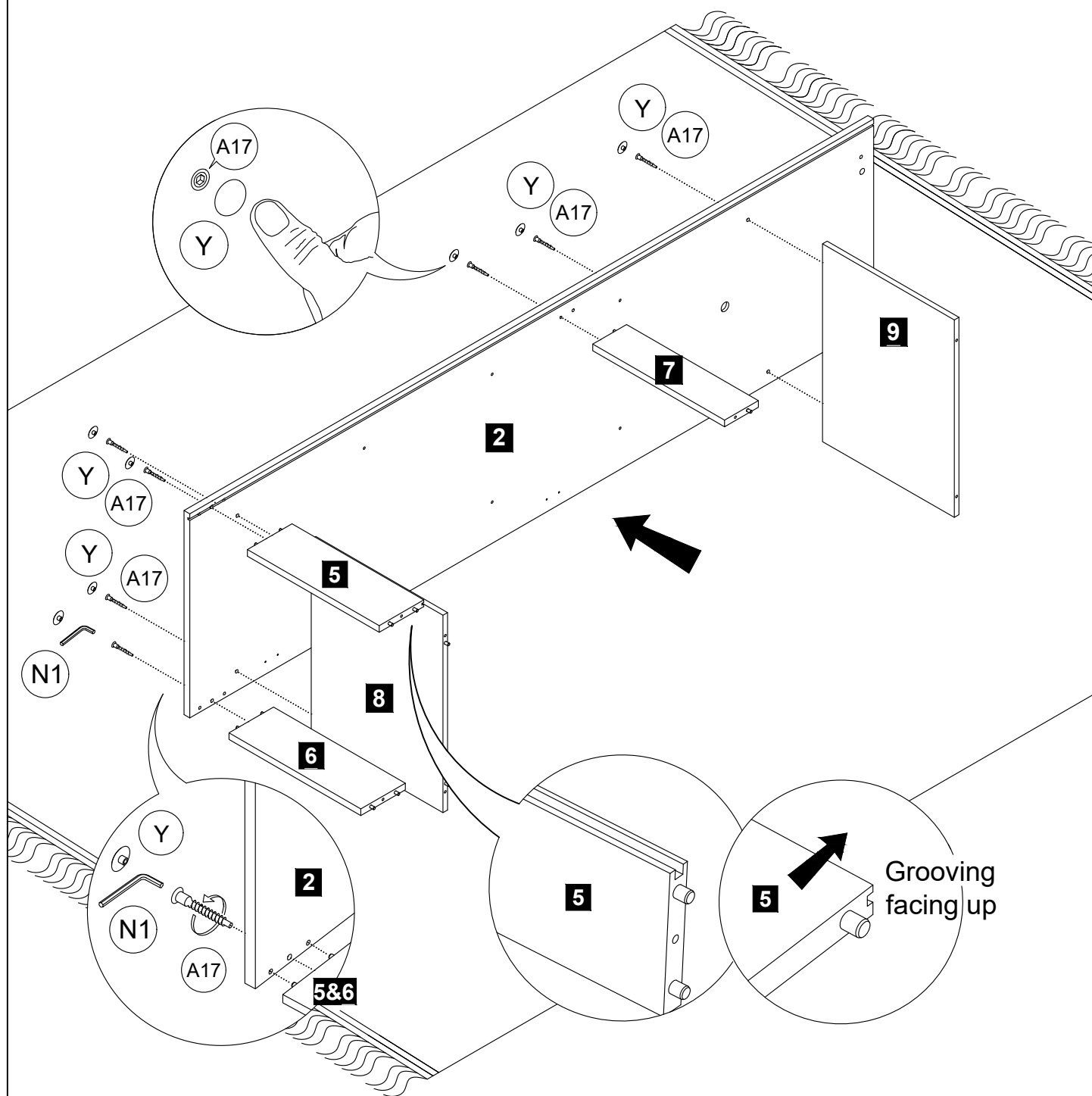

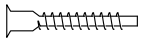
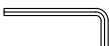
# STEP 3

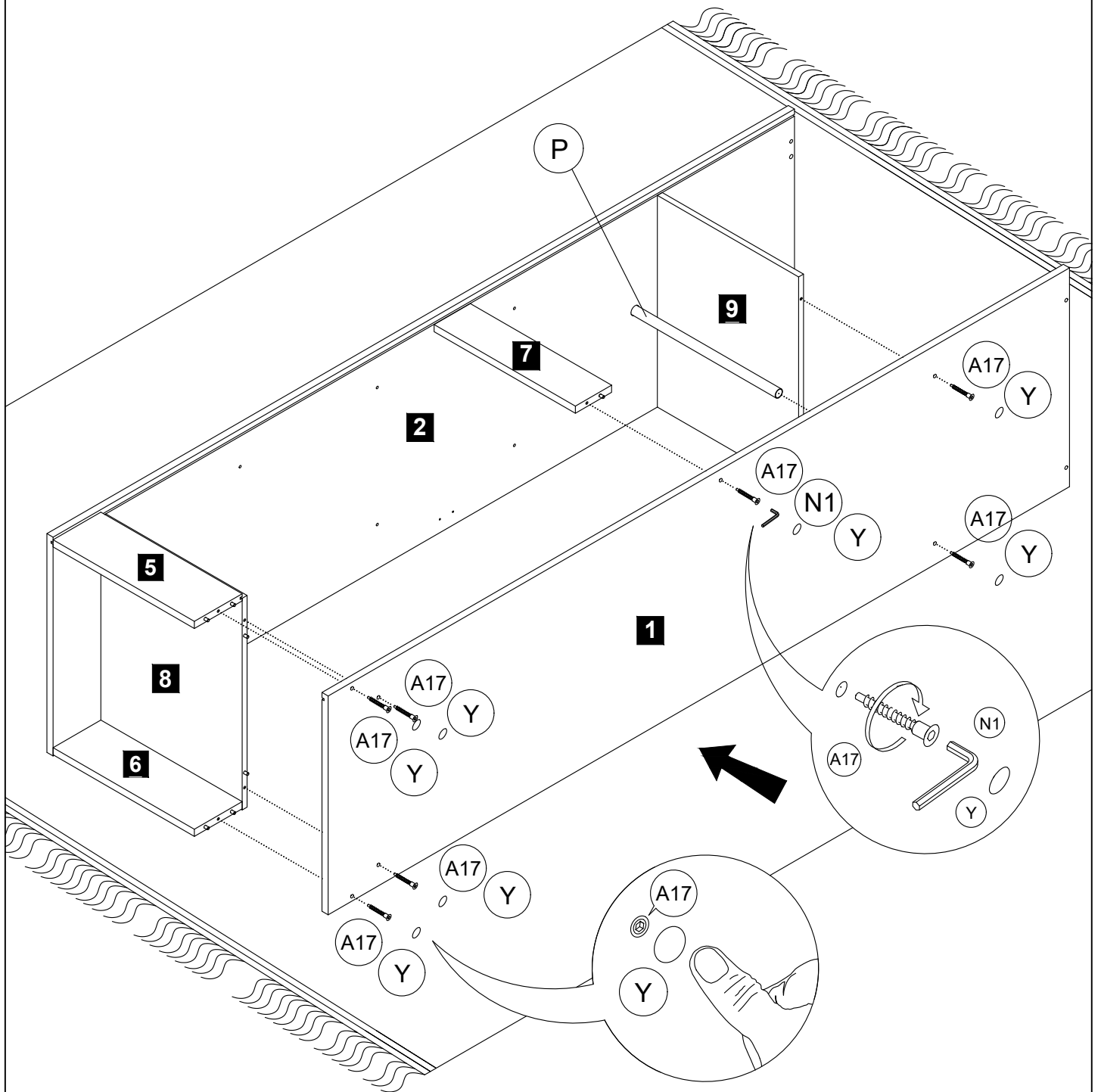

A17		Crosshead Screw m6.3 x 40mm	7 pcs
N1		Allen Key	1 pc
Y		Crosshead Cover	7 pcs

# STEP 4

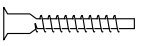
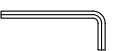



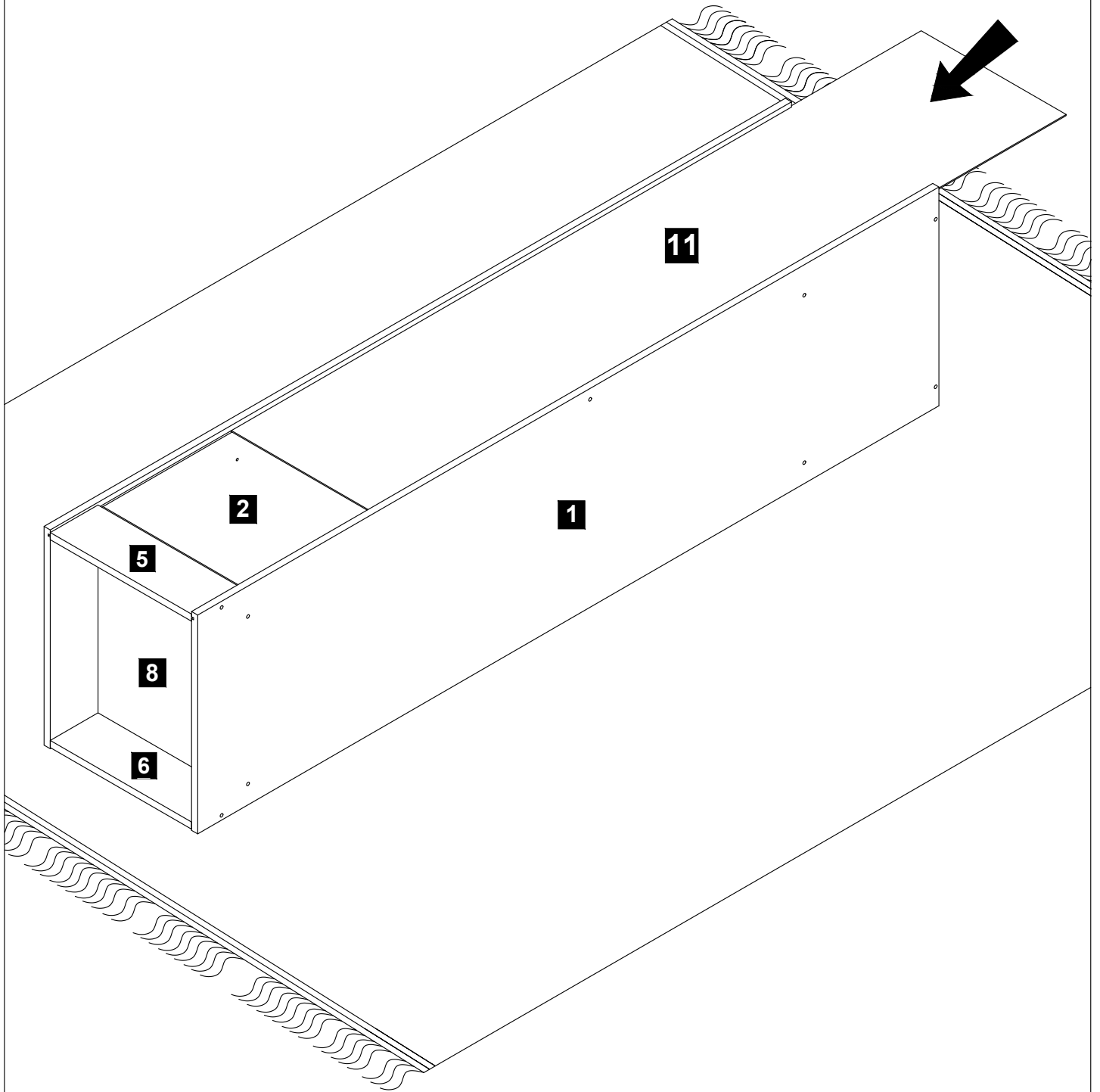

A17		Crosshead Screw m6.3 x 40mm	7 pcs
N1		Allen Key	1 pc
P		Hanging Steel Pipe 18mm x 354mm	1 pc
Y		Crosshead Cover	7 pcs

# STEP 5

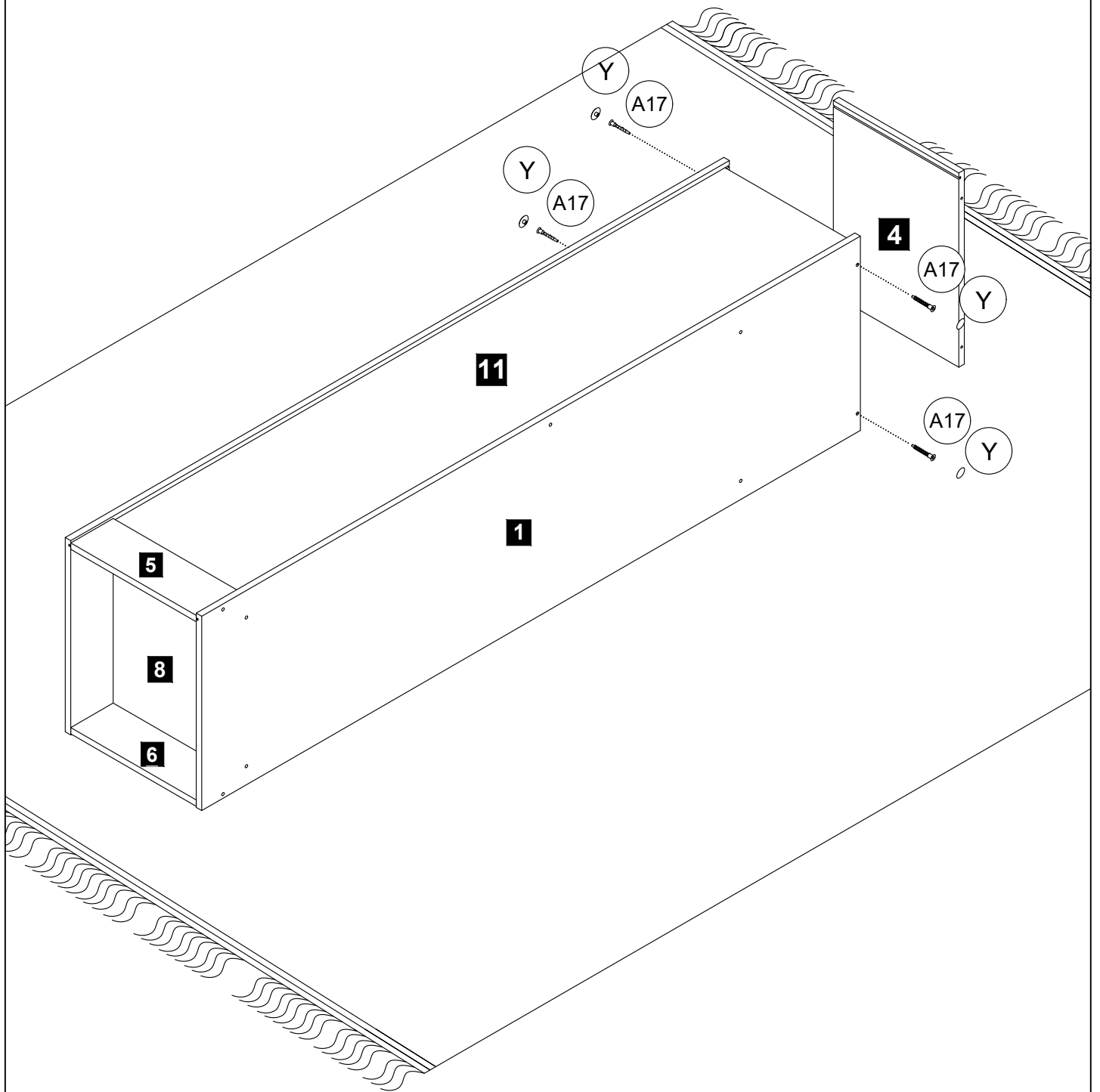





# STEP 6

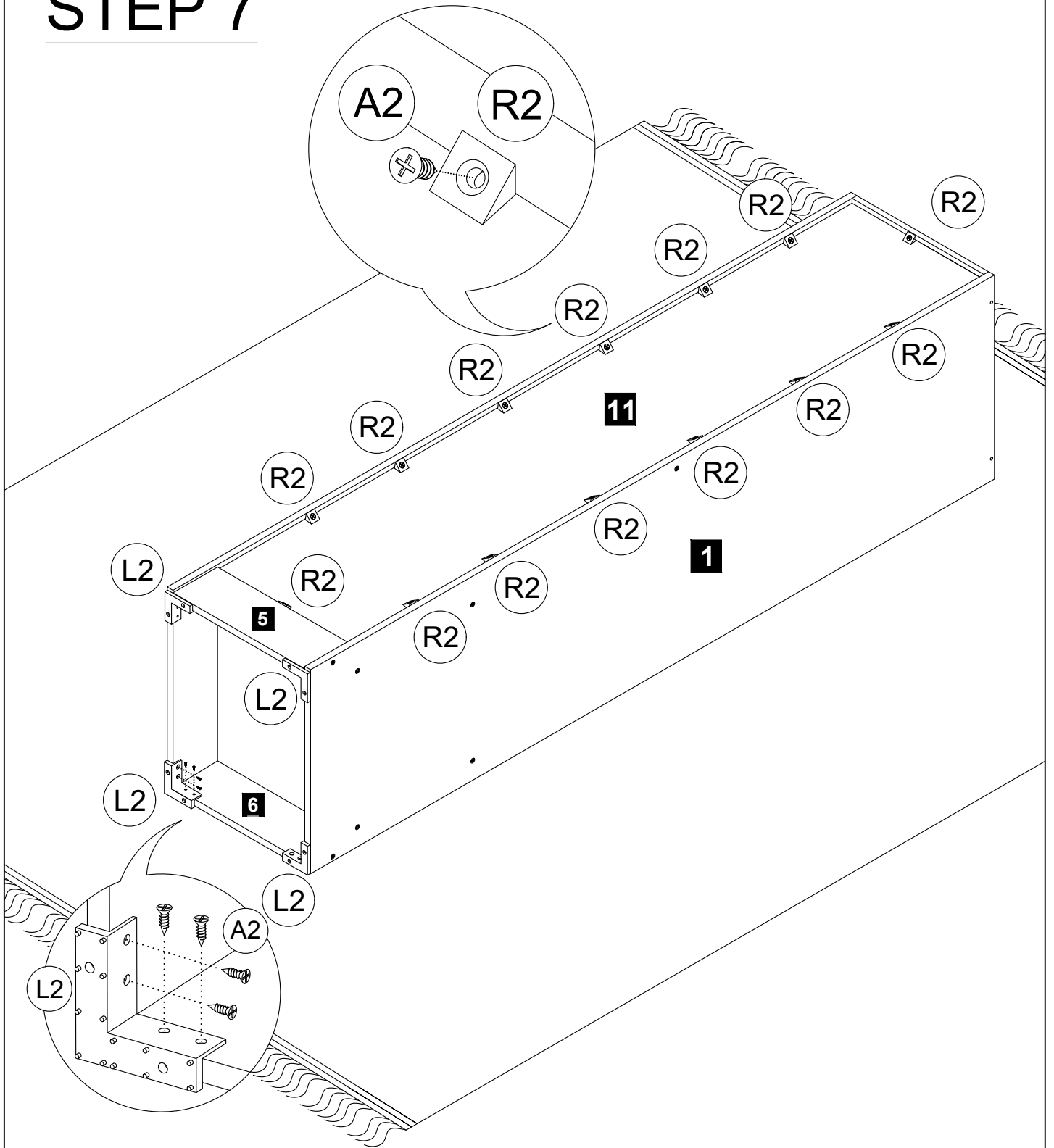

A17		Crosshead Screw m6.3 x 40mm	4 pcs
N1		Allen Key	1 pc
Y		Crosshead Cover	4 pcs

# STEP 7



A2		Screw m3.5 x 14mm	30 pcs
L2		Plastic Leg L Shape	4 pcs
R2		Single Plastic Cap	14 pcs

# STEP 8

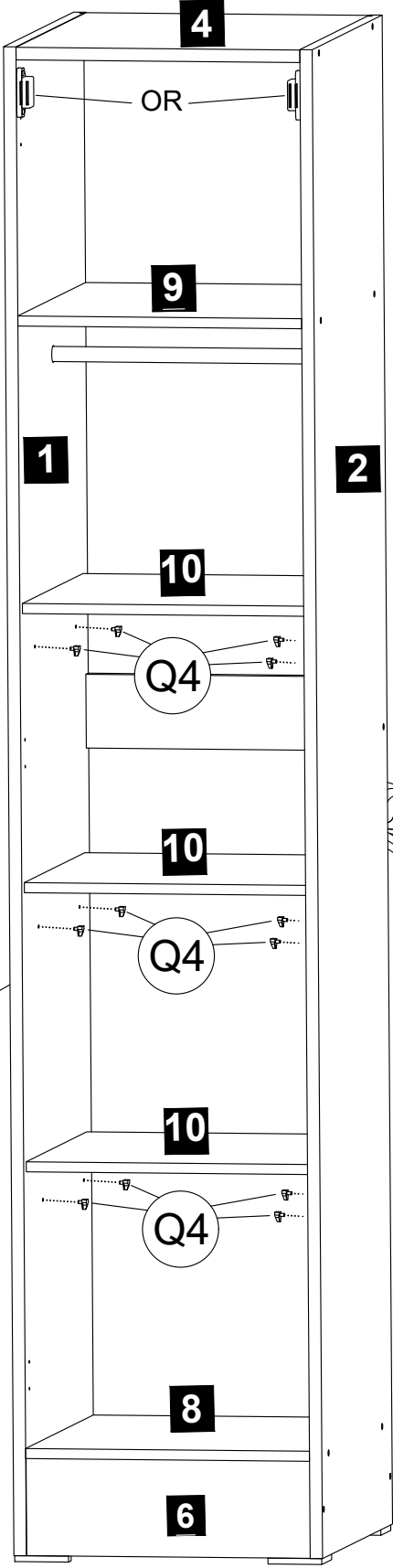

Q4		Plastic Shelf Support with Steel Pin	12 pcs
----	---	--------------------------------------	--------

# ATTENTION !

## STEP 9

If door open **Left** , place **K2** at right of panel no **3**  
 If door open **Right** , place **K2** at left of panel no **3**

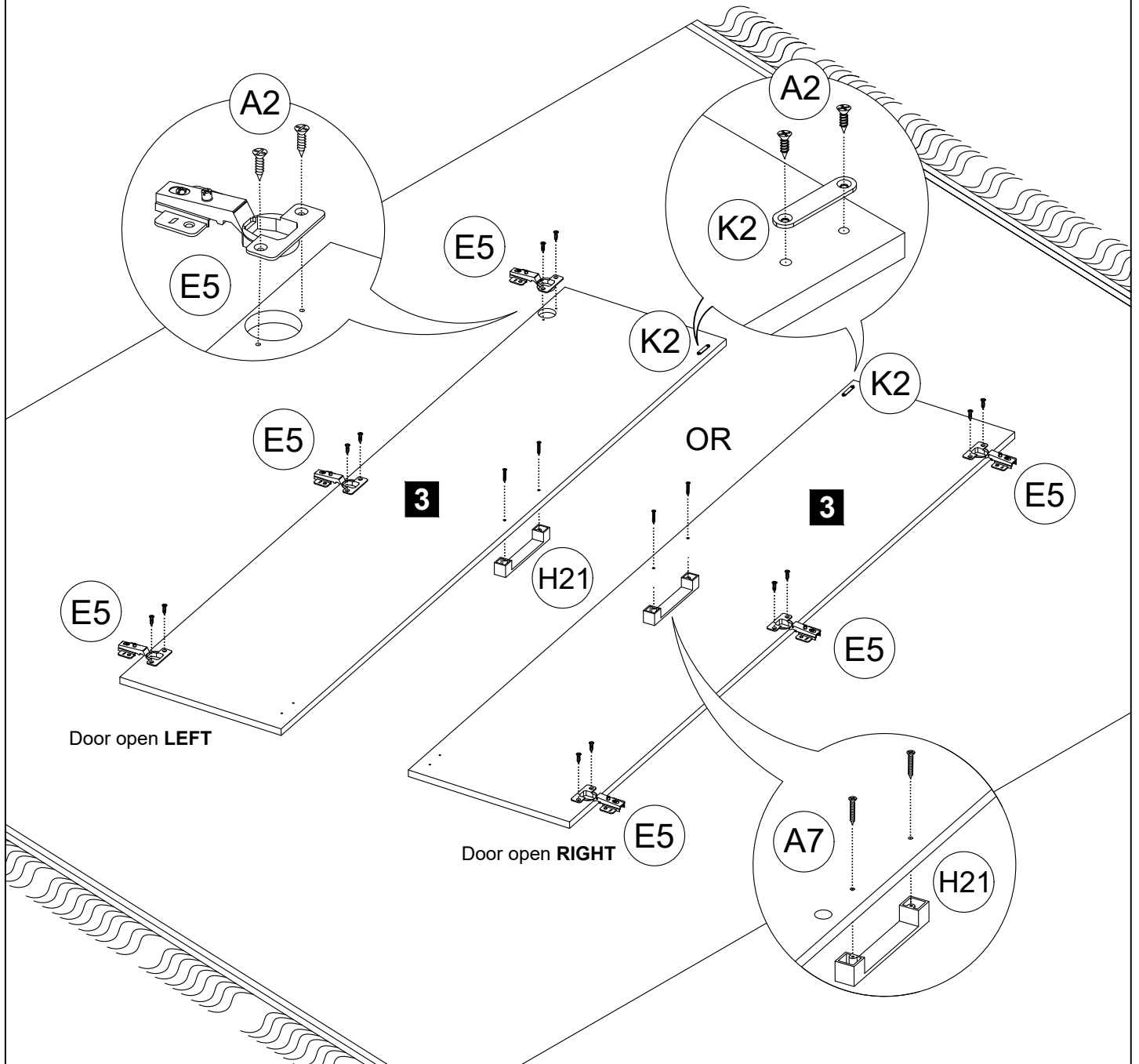

A2		Screw m3.5 x 14mm	8 pcs
A7		Screw m4 x 30mm	2 pcs
E5		Soft Closing Hinge 5/8	3 pcs
H21		Handle 128mm	1 pcs
K2		Magnet Catch_5kg	1 pc

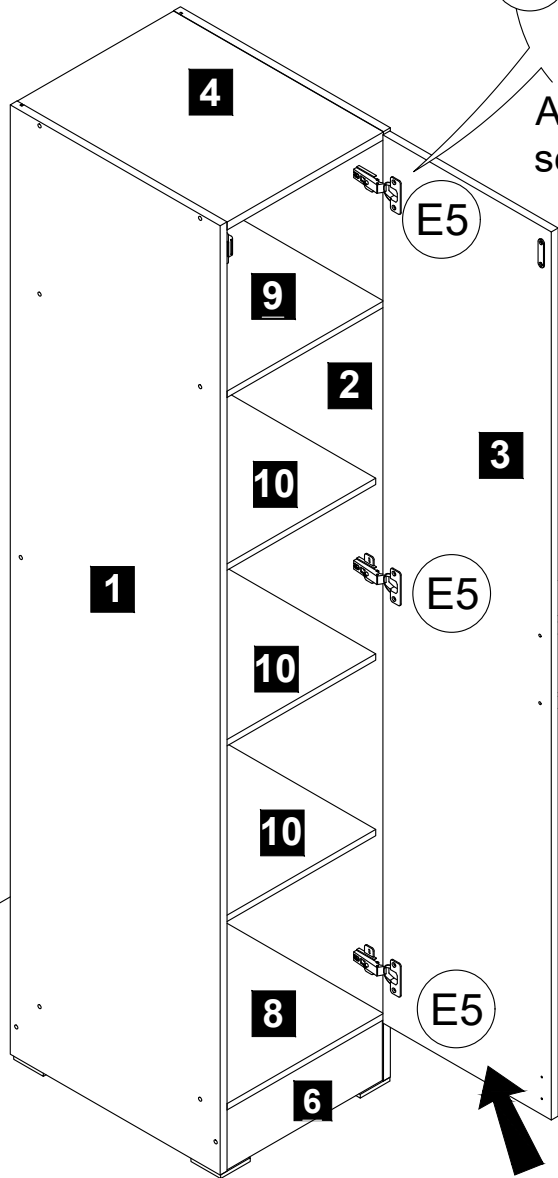
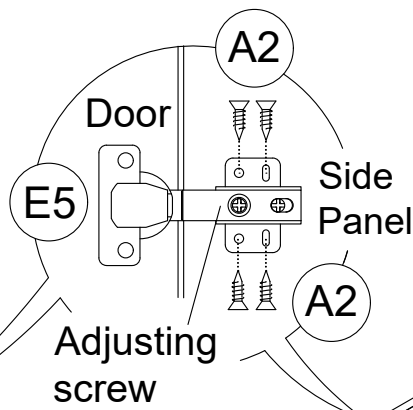

# STEP 10

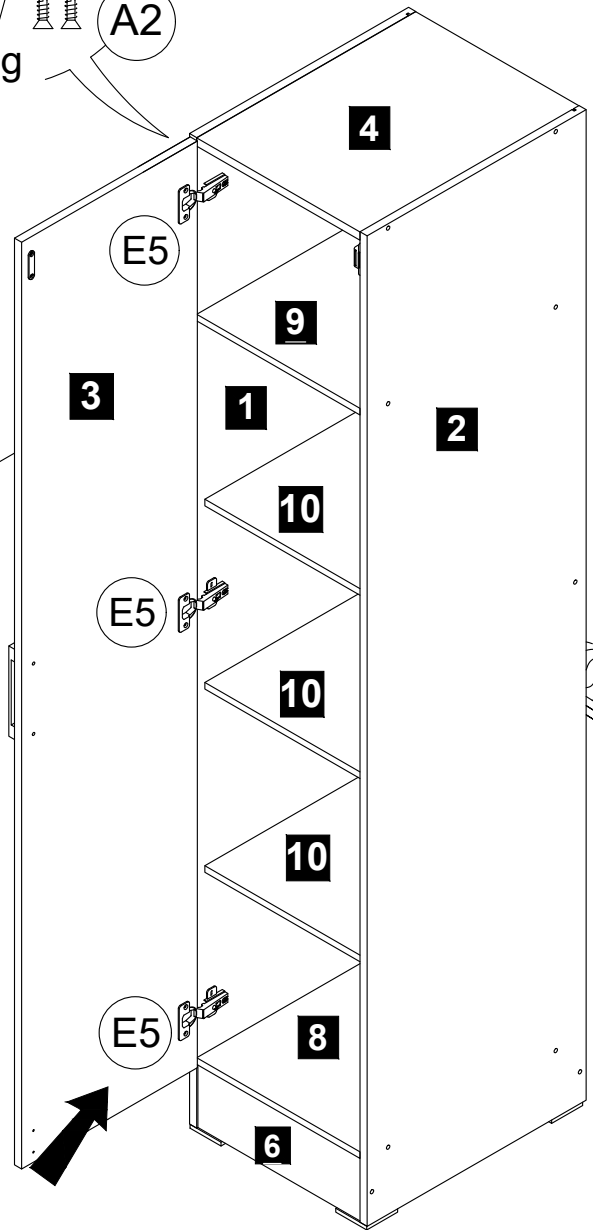

Door open **LEFT**



Door open **RIGHT**

A2		Screw m3.5 x 14mm	12 pcs
E5		Soft Closing Hinge 5/8	3 pcs

# DOOR ADJUSTMENT

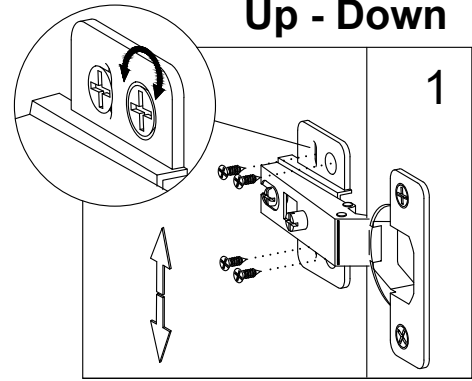
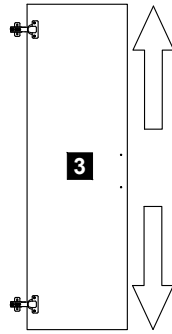
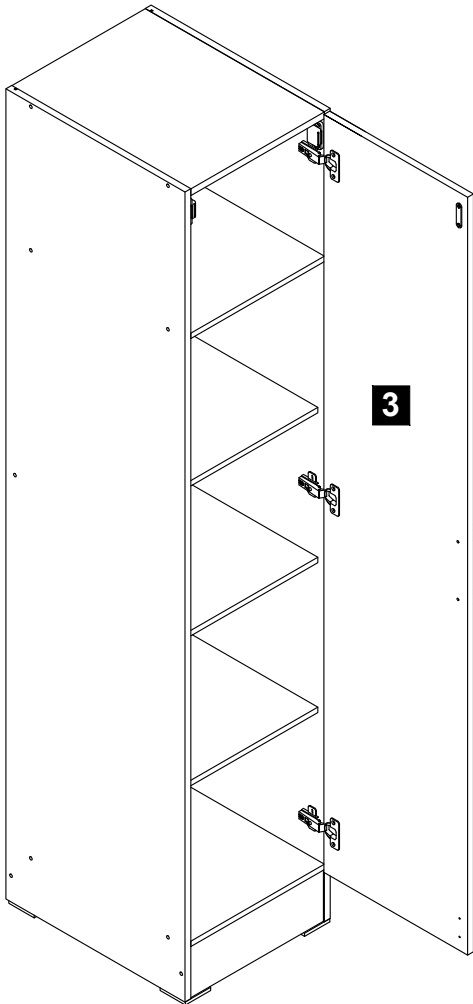

If the doors are not aligning move hinge up or down

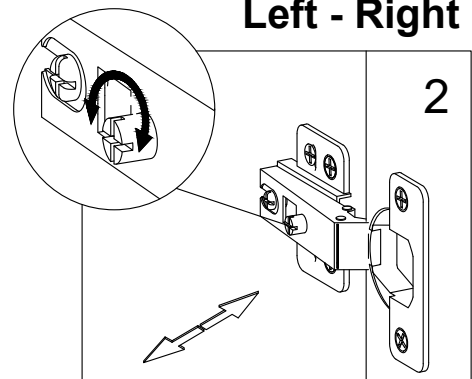
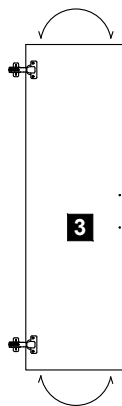

-If doors are over lapping each other or not parallel.  
-If the gap between the doors is too large or too small.

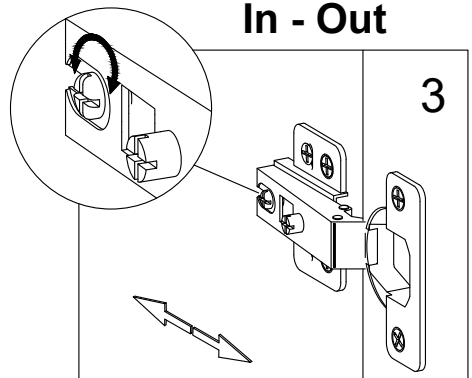
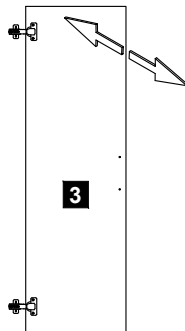

If the doors are rubbing against the sides of the closet move them away to increase the swing of the door.

# INSTALLATION OF TIPOVER RESTRAINT KIT

The Tipover Restraint Kit is highly recommended for this piece of furniture.

**(Please take this into extra consideration around young toddlers and children)**

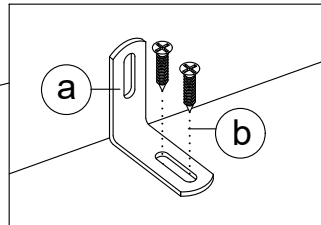
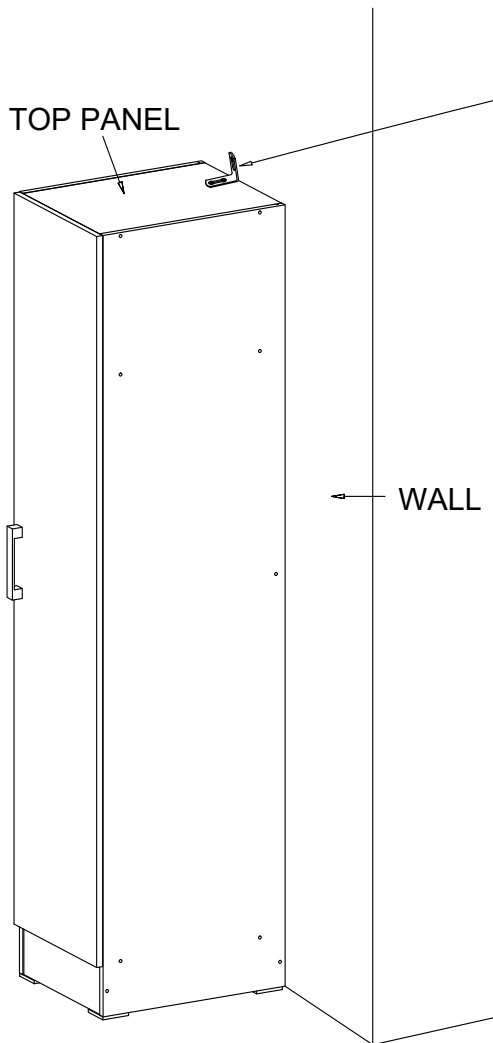

## STEP 1:

- Attach the mounting bracket (a) to the the top panel near the edge of the side of the unit.
- Screw (b) through the two holes of (a).

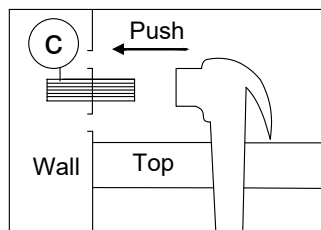

## STEP 2:

- Insert the wall plug (d) into the wall behind the unit.

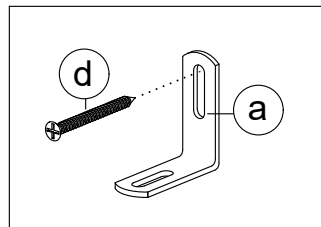

## STEP 3:

- Attach to the mounting bracket (a) to the wall plug (c) through the hole by using (d).

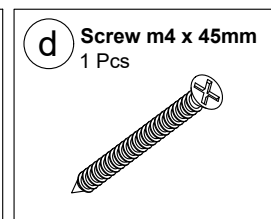
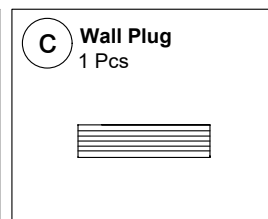
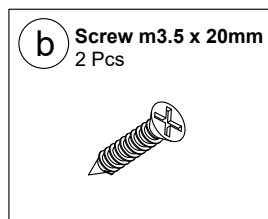
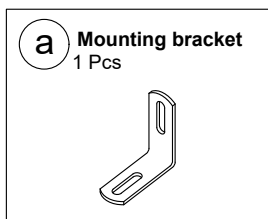

# Troubleshooting

- If the drawers are overlapping each other - **Solution:** The metal slides are placed upside down, please refer to the instruction manual.
- If the doors are overlapping each other - **Solution:** make sure the correct hinges are placed on the right door refer to the hinge assembly step on the manual.
- If the gap between the doors is too large or too small, the doors are overlapping each other, not parallel, or rubbing against the sides of the closet - **Solution:** See the page for " Door Adjustment. " or see is available below.